

目錄

目 錄

J/B	3-2	信號	
J/C	3-4	方向燈、危險警告燈	3-55
中繼盒.....	3-10	倒車燈.....	3-59
電源分配系統.....	3-16	剎車燈.....	3-60
起動系統.....	3-21	喇叭.....	3-61
點火系統.....	3-22	綜合儀錶	
充電系統.....	3-23	儀錶.....	3-62
引擎控制		燃油不足警告燈.....	3-65
4G18.....	3-24	機油壓力警告燈.....	3-66
4G93.....	3-30	剎車警告燈.....	3-66
冷卻系統.....	3-36	車門開關控制	
INVECS-III CVT.....	3-37	電動窗.....	3-67
照明		中控鎖.....	3-71
頭燈.....	3-43	空調	
尾燈、位置燈、牌照板燈、		手動冷氣機.....	3-73
燈光監視蜂鳴器.....	3-46	全自動冷氣機.....	3-77
室內燈、行李箱燈、點火開關			
照明燈.....	3-50		
前霧燈.....	3-53		

視界保全

擋風玻璃雨刷和噴水器.....	3-83
除霧線	
<安裝手動空調的車>.....	3-86
除霧線、後視鏡除霧	
<安裝全自動空調的車>	3-87
電動遙控後視鏡	3-89

附件

時鐘	3-90
點煙器、煙灰缸照明燈.....	3-91

裝備品

ABS	3-92
SRS 氣囊.....	3-96
天窗	3-98
鑰匙未取出蜂鳴器.....	3-101
燈光調整器	3-102
電動座椅、電動護腰器	3-103
遙控防盜	3-106
電動後遮陽簾.....	3-108
角燈	3-109
倒車雷達.....	3-110
免持聽筒行動電話.....	3-111

<備忘錄>

J/B

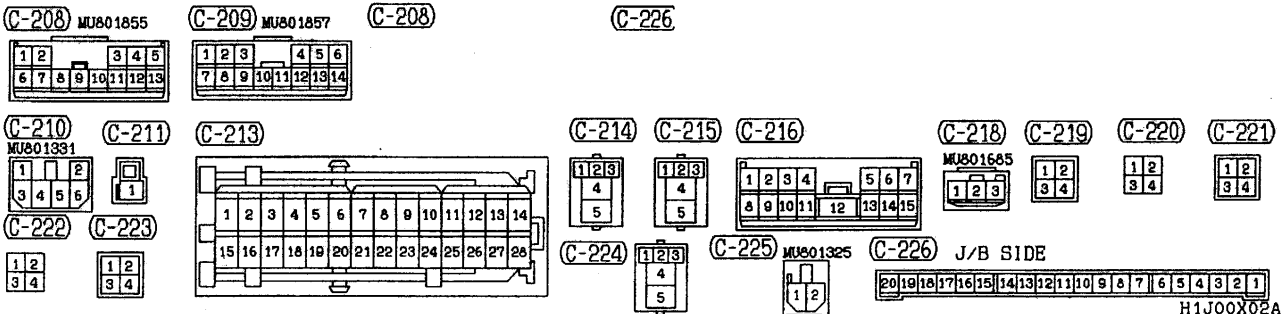
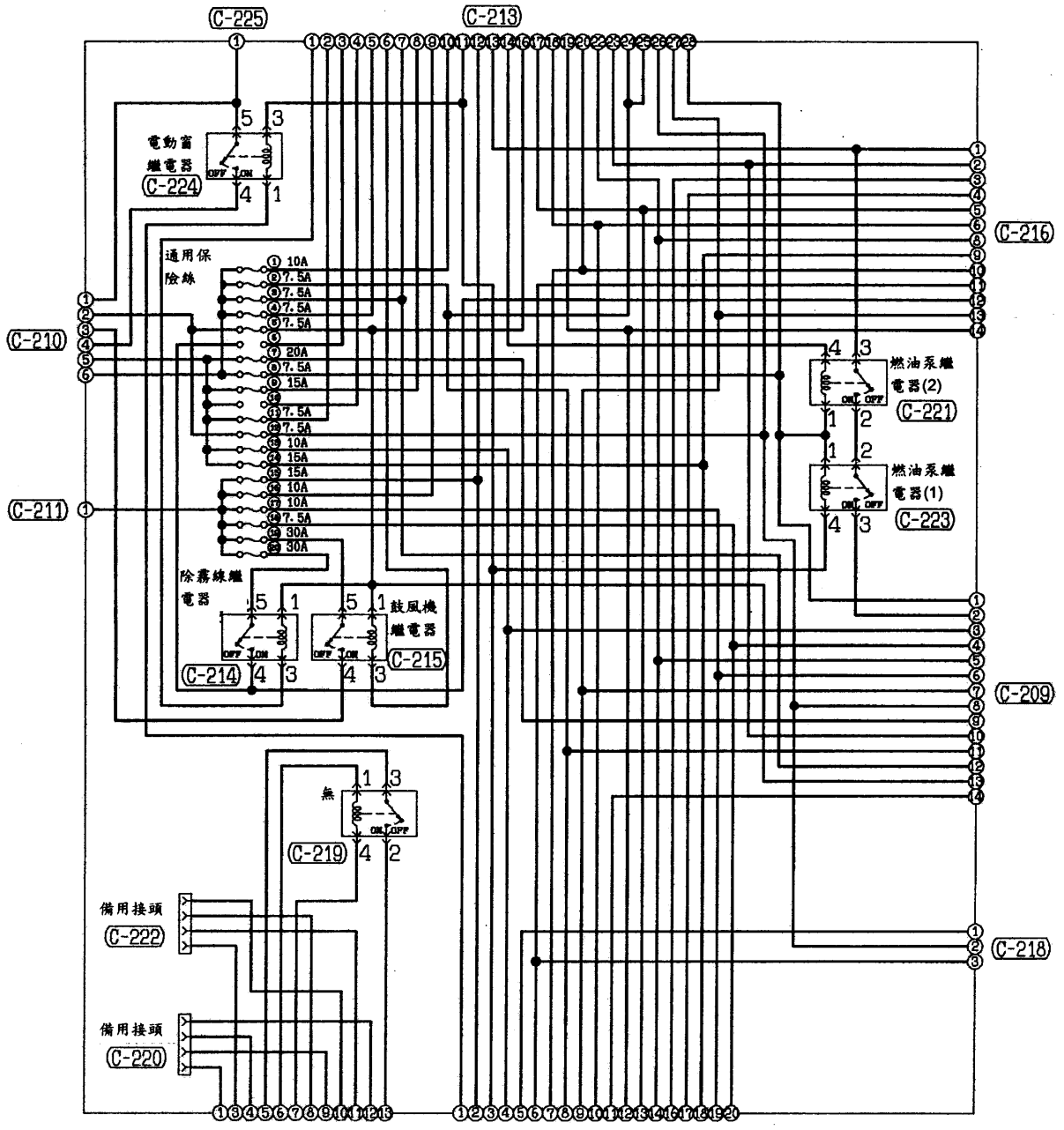

H1J00X02AA

正面

背面

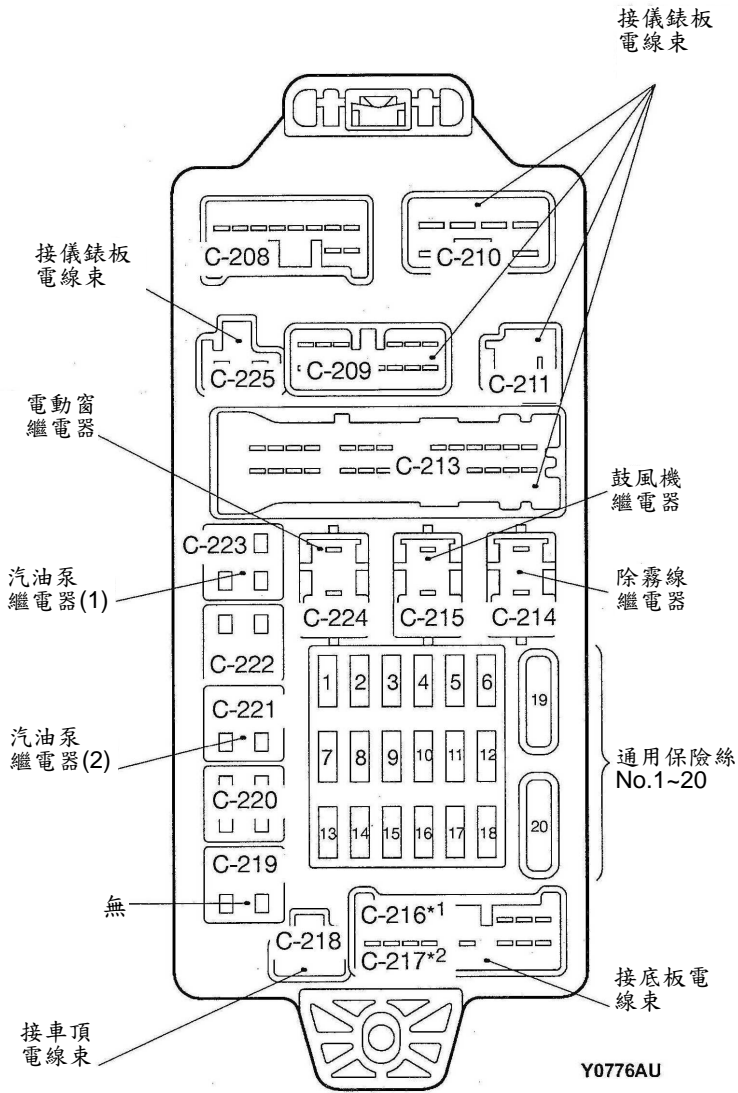

ETACS-ECU

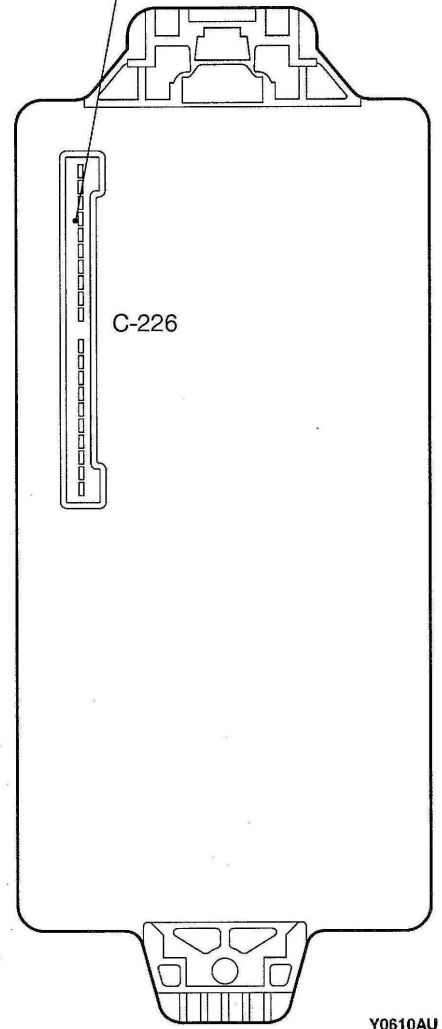

J/C

J/C (1)
(C-05)

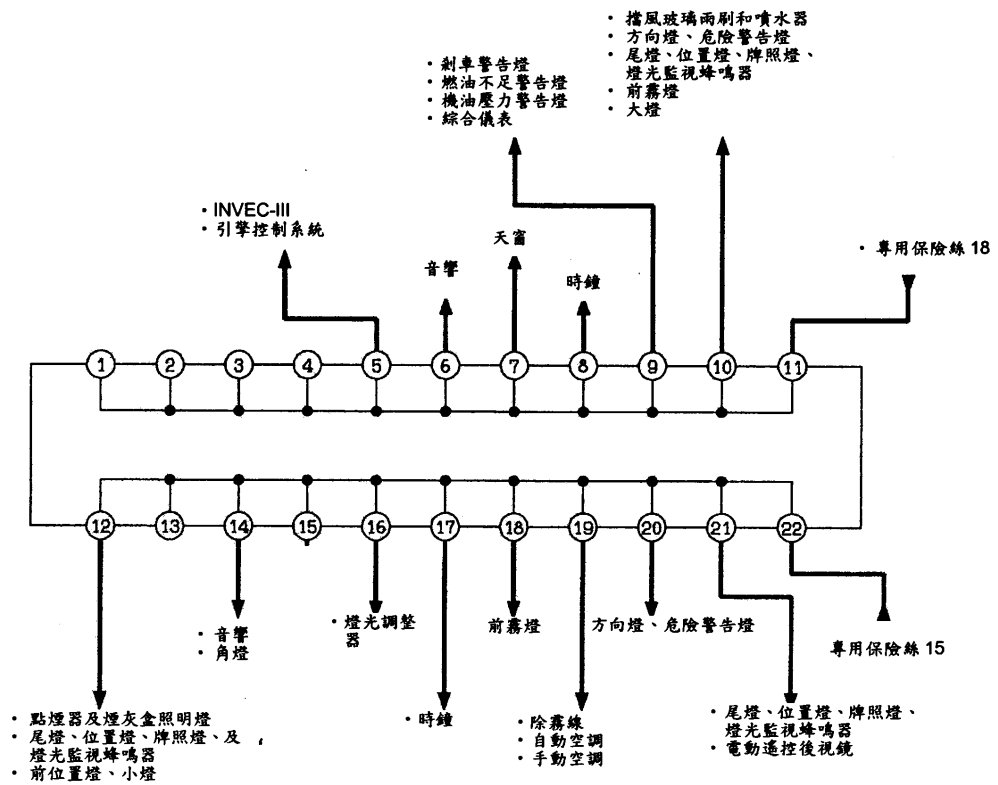

(C-05)

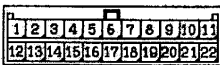

(C-102)

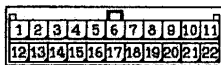

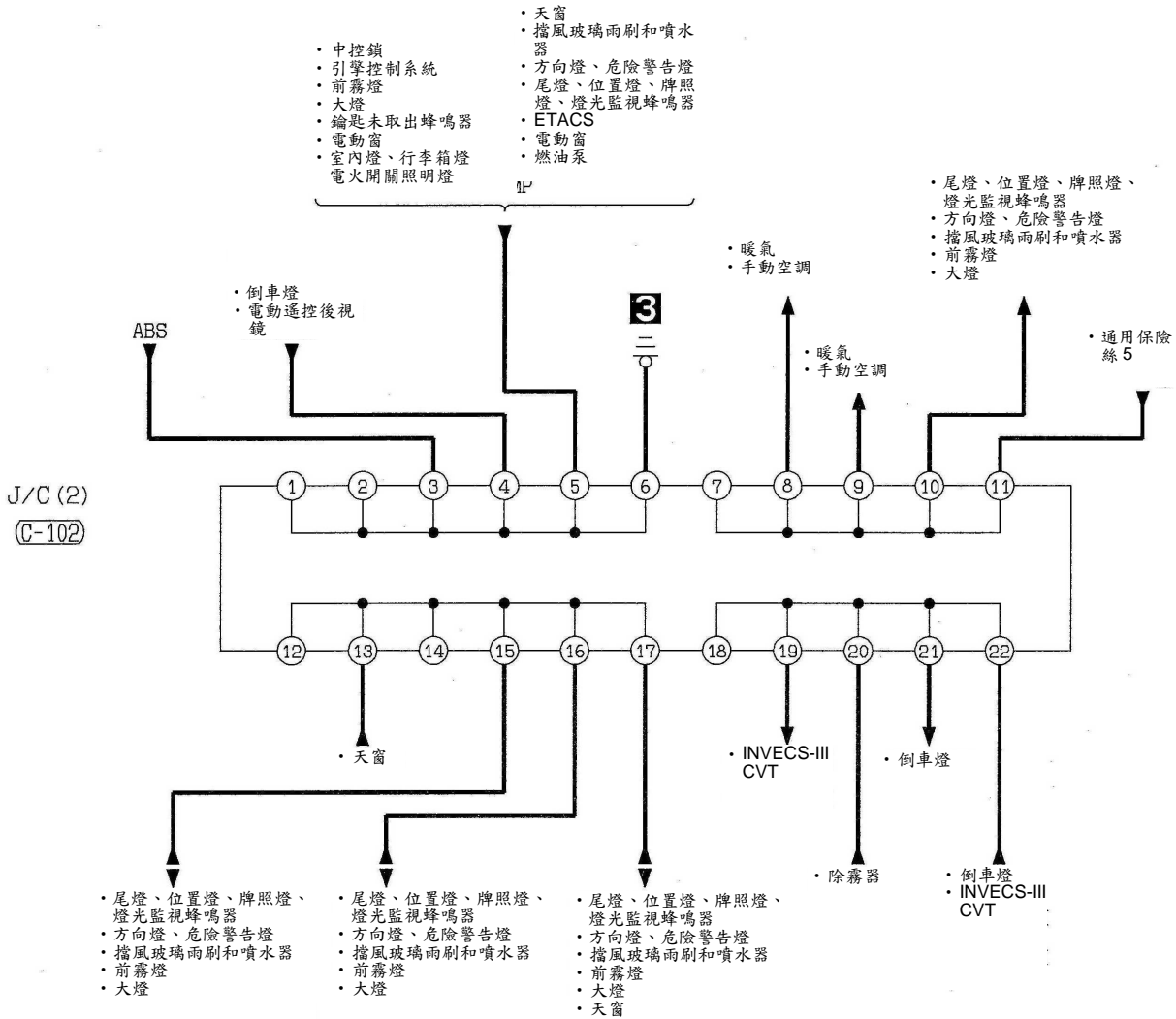

J/C (續)

J/C (3)
(C-08)

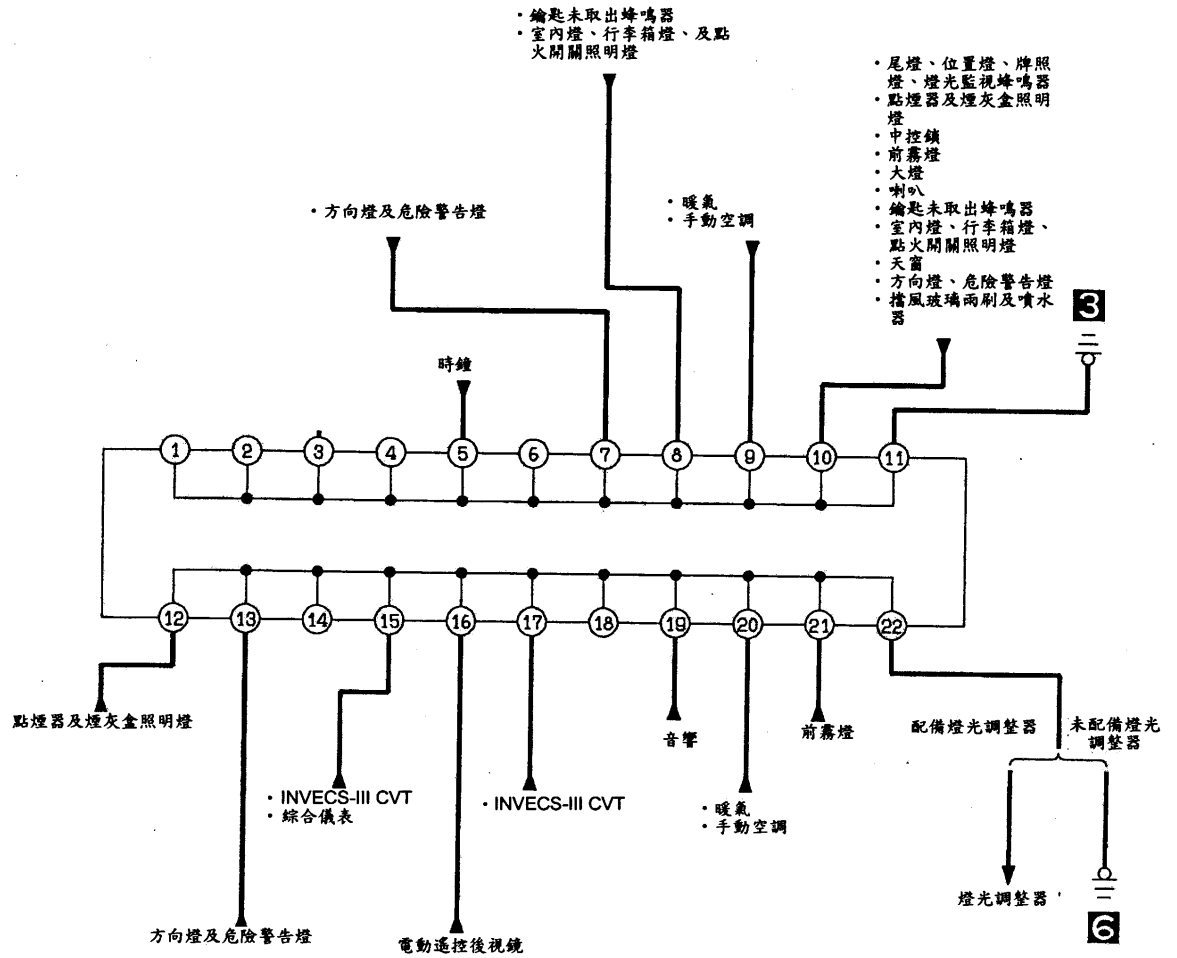

(C-08)

1	2	3	4	5	6	7	8	9	10	11
12	13	14	15	16	17	18	19	20	21	22

(C-26)

1	2	3	4	5	6	7	8	9	10	11
12	13	14	15	16	17	18	19	20	21	22

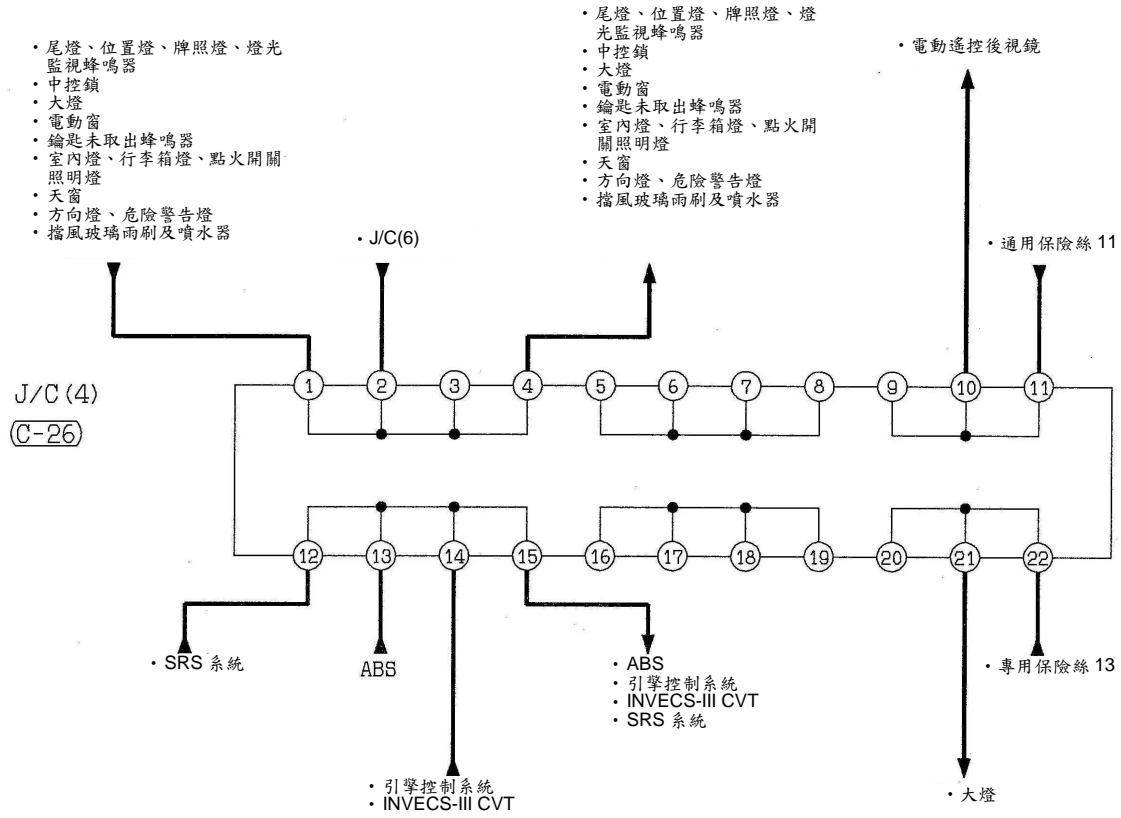

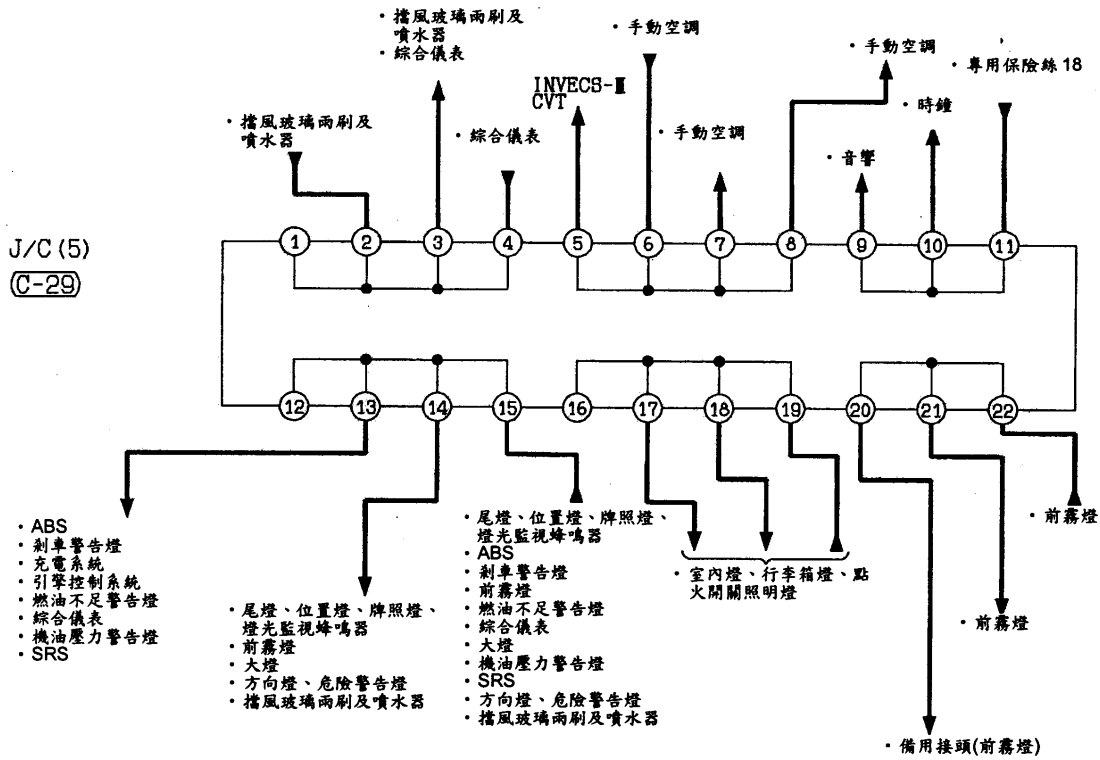

(C-29)

1	2	3	4	5	6	7	8	9	10	11
12	13	14	15	16	17	18	19	20	21	22

(C-108)

1	2	3	4	5	6	7	8	9	10	11
12	13	14	15	16	17	18	19	20	21	22
23	24	25	26	27	28	29	30	31	32	33

J/C (6)
(C-108)

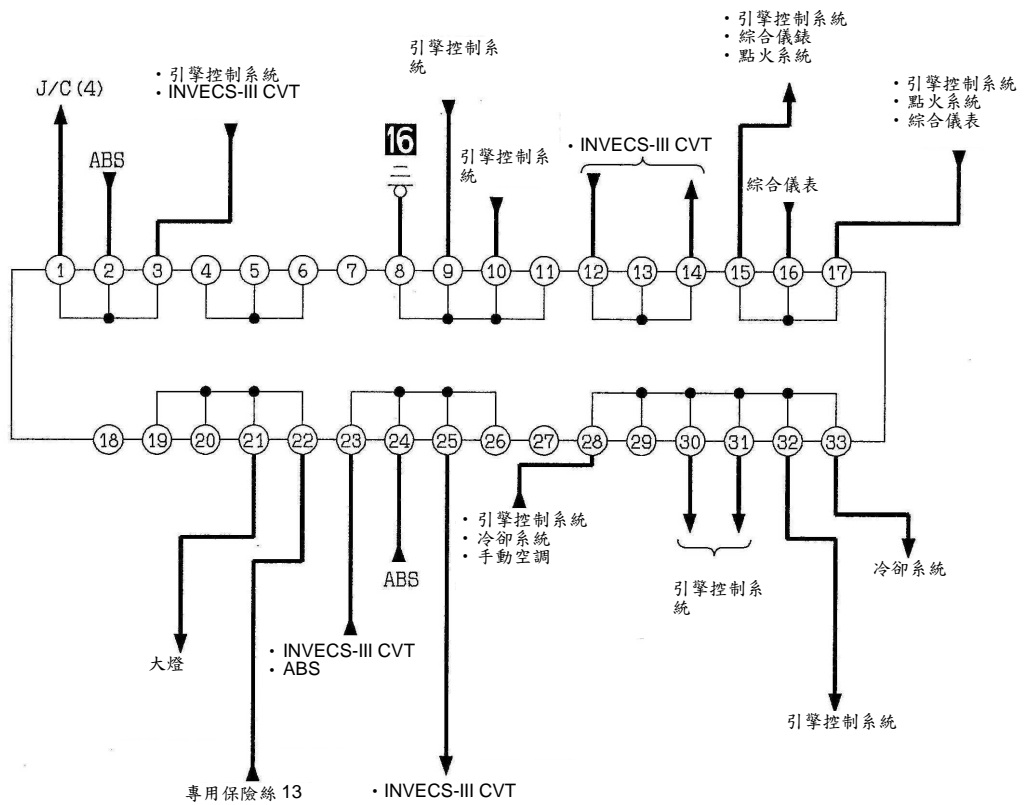

中繼盒

易熔絲

No.	使用迴路	型式	外殼顏色	規定容量(A)
1	通用保險絲 No.15、16、17、18、19、20	螺絲固定型	黃	60
2	全自動空調、手動空調、冷卻系統	接頭型	紅	50
3	ABS	接頭型	黃	60
4	點火開關	接頭型	綠	40
5	專用保險絲 No.23	接頭型	綠	40
6	電瓶/易熔絲 No.1、2、3、4、5；專用保險絲 No.1、2、3、4、5、6、7、8、9、10、18、起動系統、前 ECU	螺絲固定型	—	100

引擎室內繼電器盒

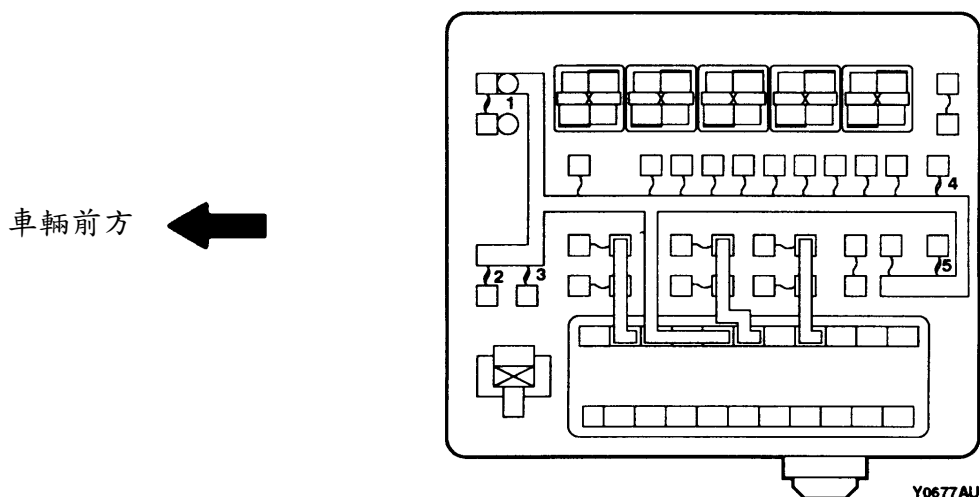

直接與電瓶正極連接之易熔絲

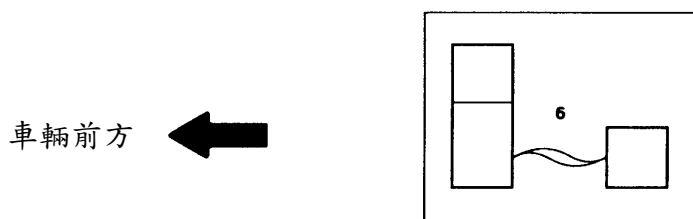

• 專用保險絲

電源迴路	保險絲 No.	規定容 量(A)	識別色	使用負荷
電瓶/交流發電機 (易熔絲 No.6)	1	15	藍	綜合儀表、前霧燈、前霧燈繼電器、
	2	10	紅	喇叭繼電器
	3	20	黃	引擎控制繼電器、點火線圈控制繼電器、 節氣閥控制伺服繼電器
	4	10	紅	A/C 壓縮機、A/C 壓縮機繼電器
	5	15	藍	引擎-CVT-ECU、後組合燈、第三剎車燈 、ABS-ECU
	6	—	—	—
	7	7.5	棕	發電機
	8	10	紅	ETACS-ECU
	9	20	黃	CVT 控制繼電器、引擎-CVT-ECU
	10	15	藍	燃油泵
前 ECU (頭燈繼電器：HI)	11	10	紅	頭燈、遠光指示燈
	12	10	紅	頭燈
前 ECU (頭燈繼電器：LO)	13	10	紅	頭燈
	14	10	紅	頭燈
前 ECU (尾燈繼電器)	15	7.5	棕	引擎-CVT-ECU、位置燈總成、綜合儀錶 、後綜合燈、危險警告燈開關、A/C-ECU 、遙控後視鏡開關、音響、時鐘、霧燈開 關、牌照燈
	16	7.5	棕	綜合儀表、位置燈、牌照燈、後綜合燈
點火開關(ACC)	17	10	紅	時鐘、音響
電瓶/交流發電機 (易熔絲 No.6)	18	10	紅	時鐘、方向機柱開關、引擎-CVT-ECU、 前 ECU、音響、天窗馬達總成
—	19	—	—	—
—	20	—	—	—
—	21	—	—	—
易熔絲 No.4	22	20	黃	GPS、NAVI
易熔絲 No.5	23	20	黃	天窗馬達總成

引擎室內繼電器盒

車輛前方

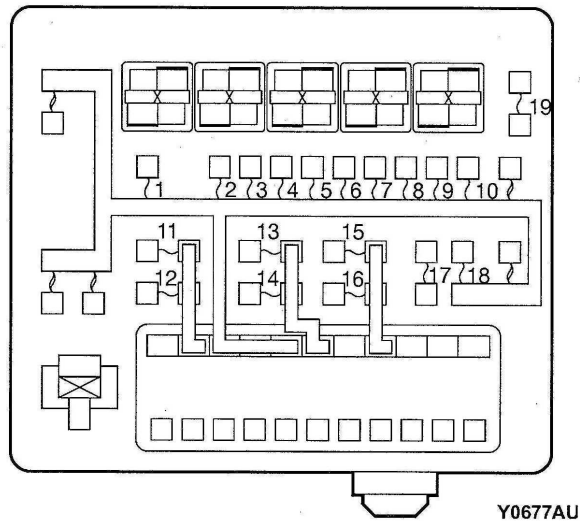
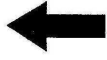

Y0677AU

J/B 中繼盒

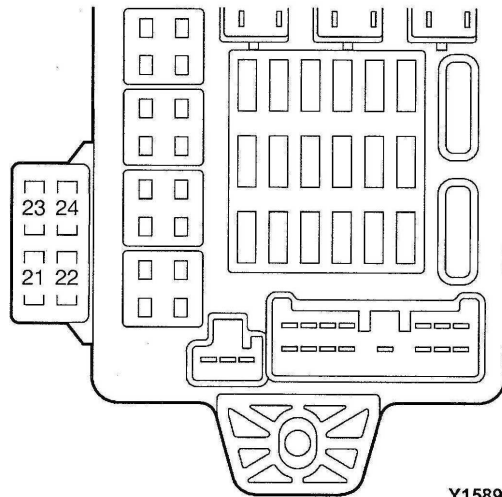

Y1589AU

• 通用保險絲(J/B)

電源迴路		保險絲 No.	規定容 量(A)	識別色	使用負荷
點火開關	IG1	1	10	紅	點火線圈
		2	7.5	棕	充電警告燈、ETACS-ECU、引擎警告燈、綜合儀錶、方向機柱開關、SRS-ECU
		3	7.5	棕	引擎-CVT-ECU、綜合儀錶、CVT 控制繼電器、後綜合燈、ETACS-ECU、音響、SRS-ECU、換檔開關
		4	—	—	—
	IG2	5	7.5	棕	前 ECU、鼓風機繼電器、內外氣切換閥門馬達、A/C-ECU、A/C 壓縮機繼電器、除霧線繼電器
易熔絲 No.1 (除霧線繼電器)		6	7.5	棕	電動遙控後視鏡
點火開關	ACC	7	20	黃	前 ECU、擋風玻璃雨刷馬達
	IG1	8	7.5	棕	引擎-CVT-ECU、燃油泵繼電器(1)、燃油泵繼電器(2)、擋風玻璃雨刷馬達
		ACC	9	15	藍
		10	—	—	—
		11	7.5	棕	A/C-ECU、遙控後視鏡開關
	IG2	12	7.5	棕	ABS-ECU、ABS 警告燈繼電器、天窗馬達總成
	ACC	13	10	紅	ETACS-ECU
		14	15	藍	ETACS-ECU
易熔絲 No.1 (電瓶/交流發電機)		15	15	藍	診斷接頭、ETACS-ECU
		16	—	—	—
		17	10	紅	ETACS-ECU
		18	7.5	棕	ETACS-ECU
		19	30	綠	鼓風機馬達、電阻器
		20	30	綠	阻流線圈、除霧線

J/B (中繼盒)

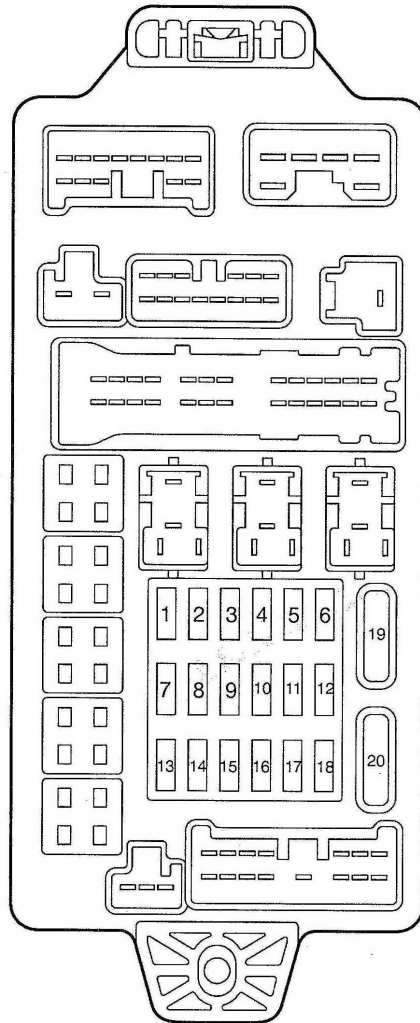

• 繼電器盒(引擎室內繼電器盒)

接頭號碼	名稱	接頭號碼	名稱
A-04X	前霧燈繼電器	B-05X	引擎轉數偵測接頭
A-05X	喇叭繼電器	B-06X	—
A-06X	—	B-07X	—
A-07X	—	B-08X	—
A-08X	—	B-09X	—
A-09X	冷卻風扇控制繼電器	B-10X	CVT 控制繼電器
A-10X	前 ECU	B-11X	引擎控制繼電器
A-11X	前 ECU	B-12X	A/C 壓縮機繼電器

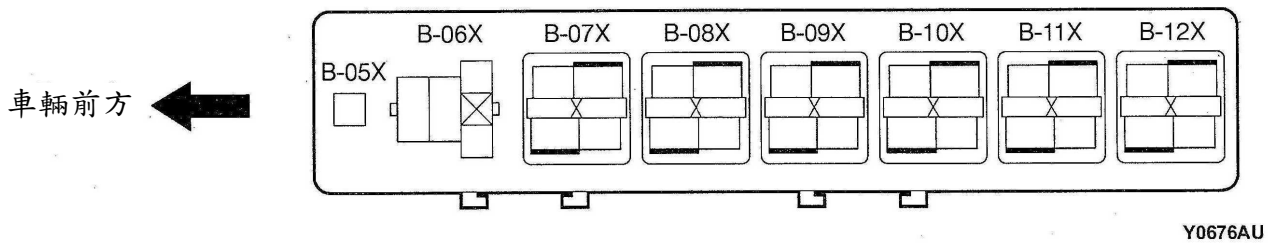
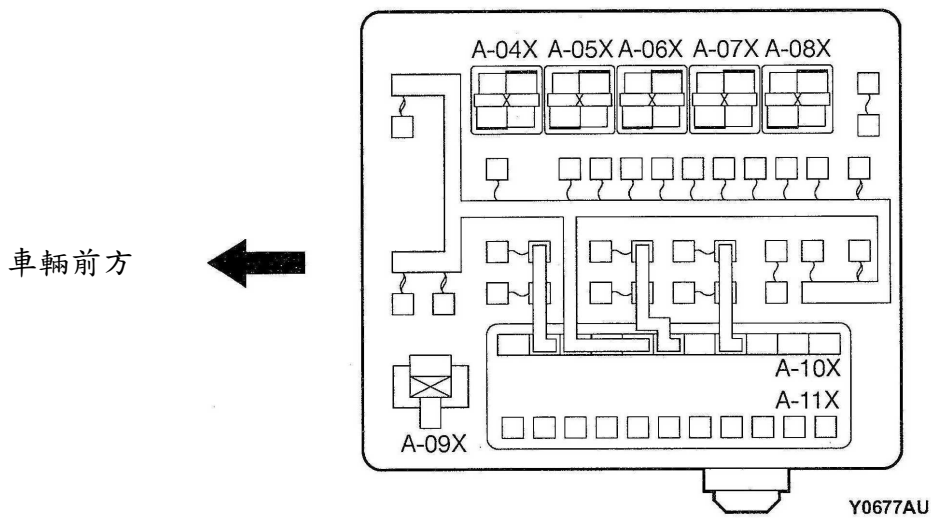

電源分配系統

1

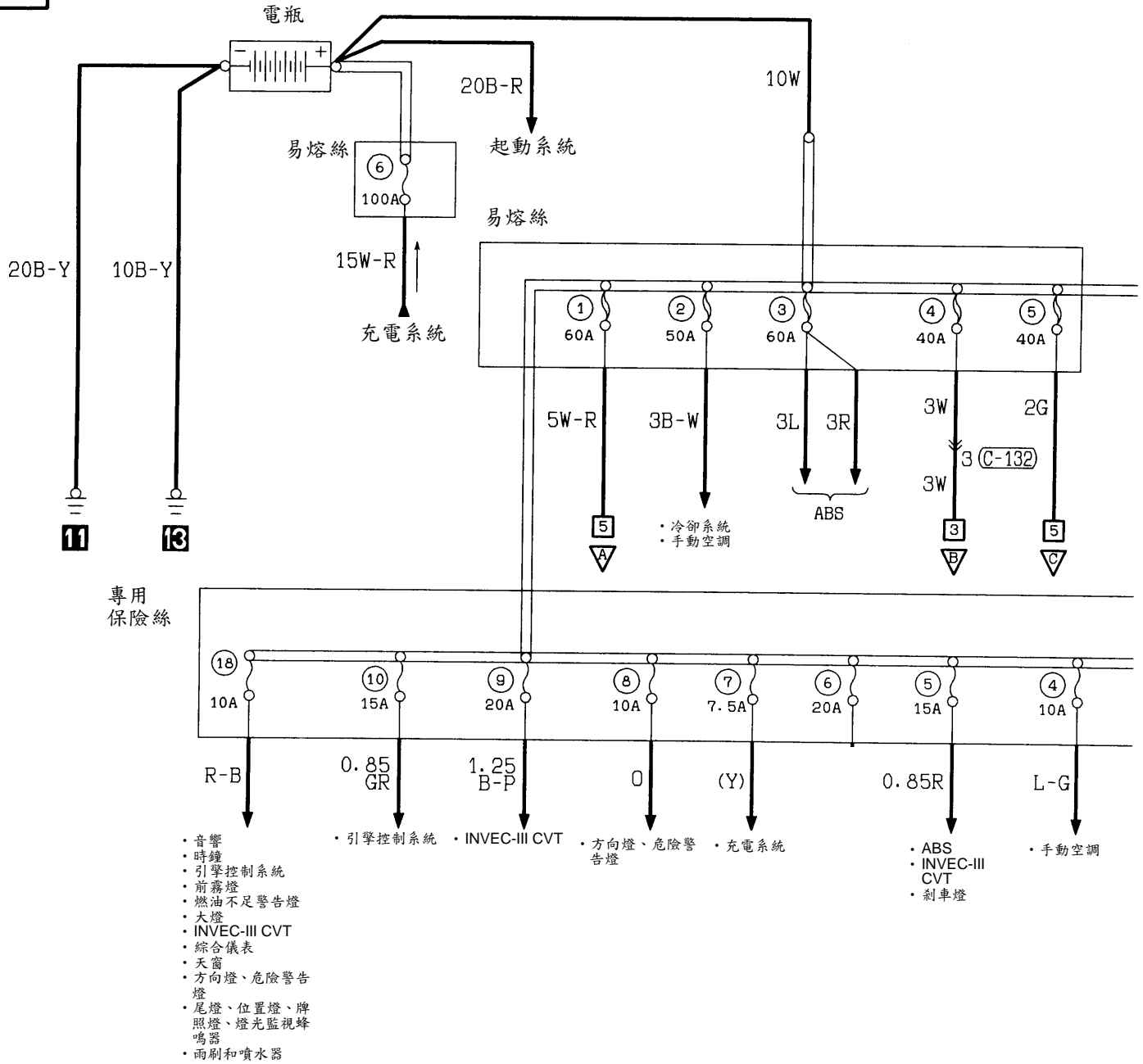

(A-10X)

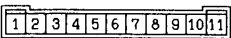

(C-132)



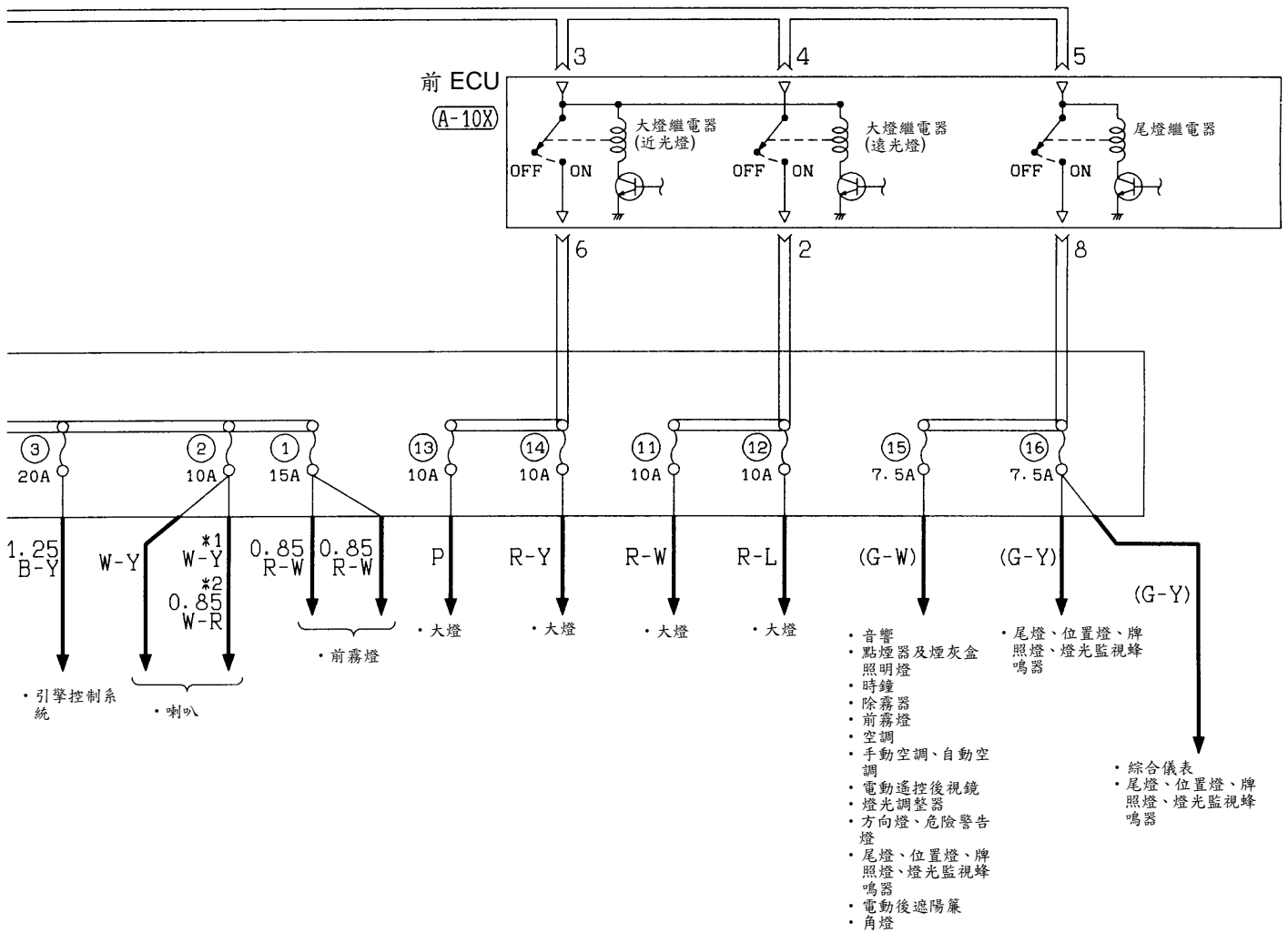

3

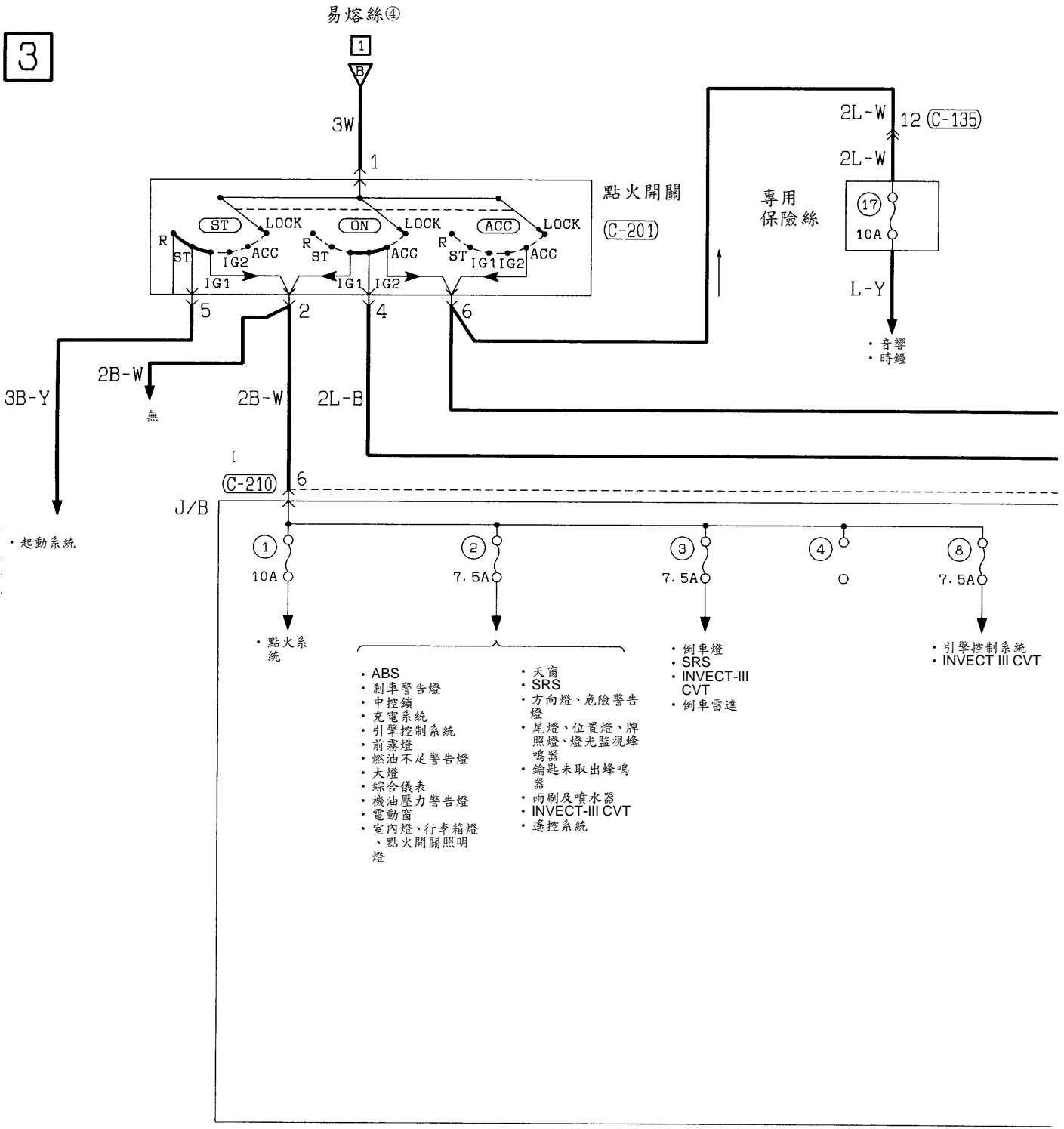

(C-135)

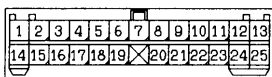

(C-201)



(C-210)

MU801331



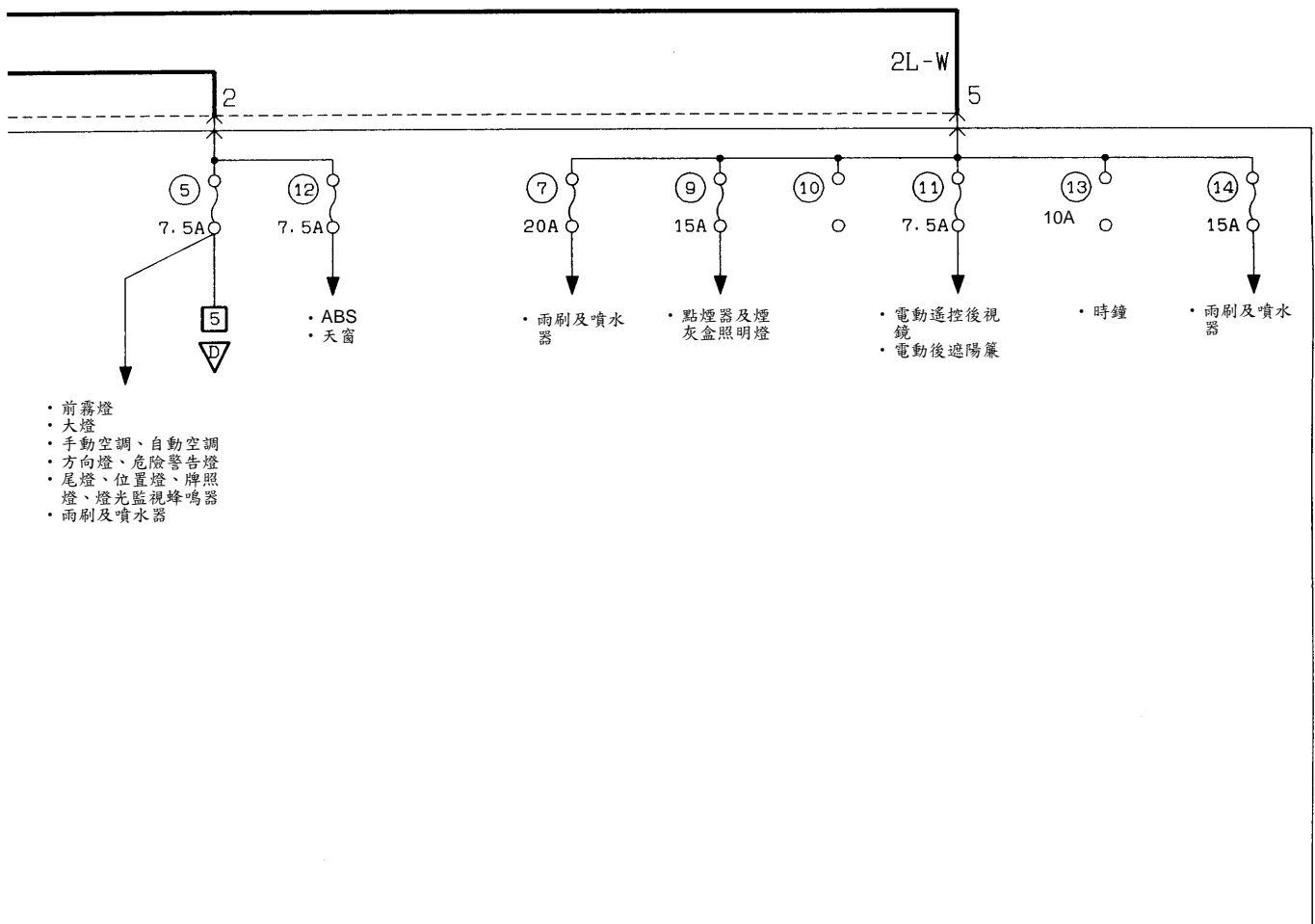

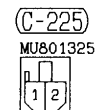
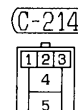
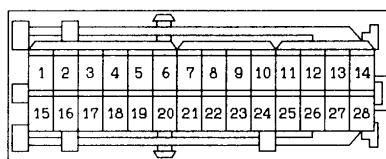
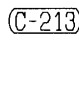
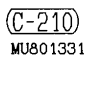
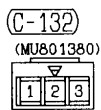
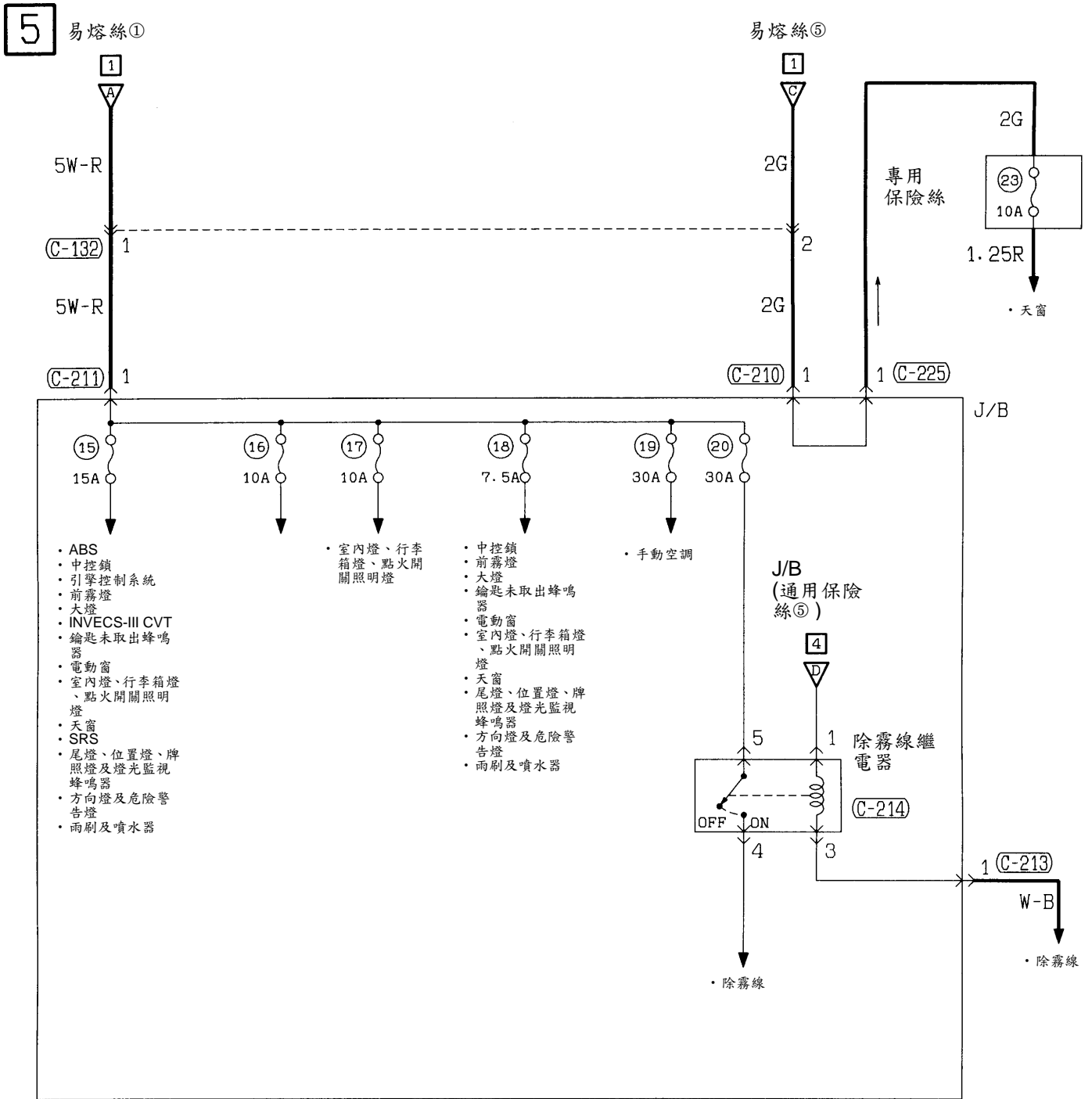

1

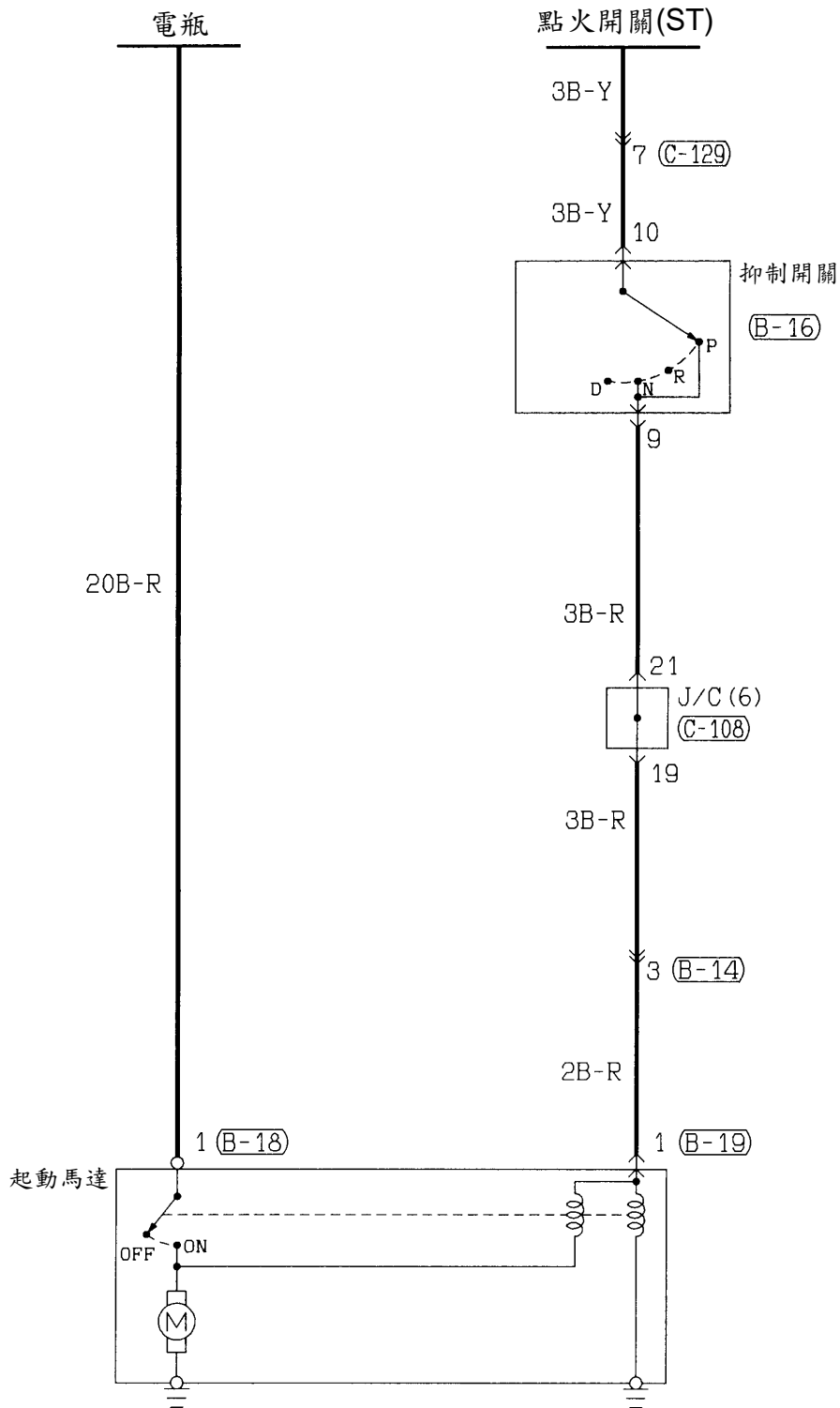

(B-14)

(B-16)



MU802607 MU802355

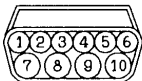

(B-18)

(B-19)

(C-108)

(C-129)

1

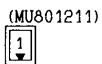

(MU801211)



MU801867

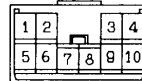

點火系統

1

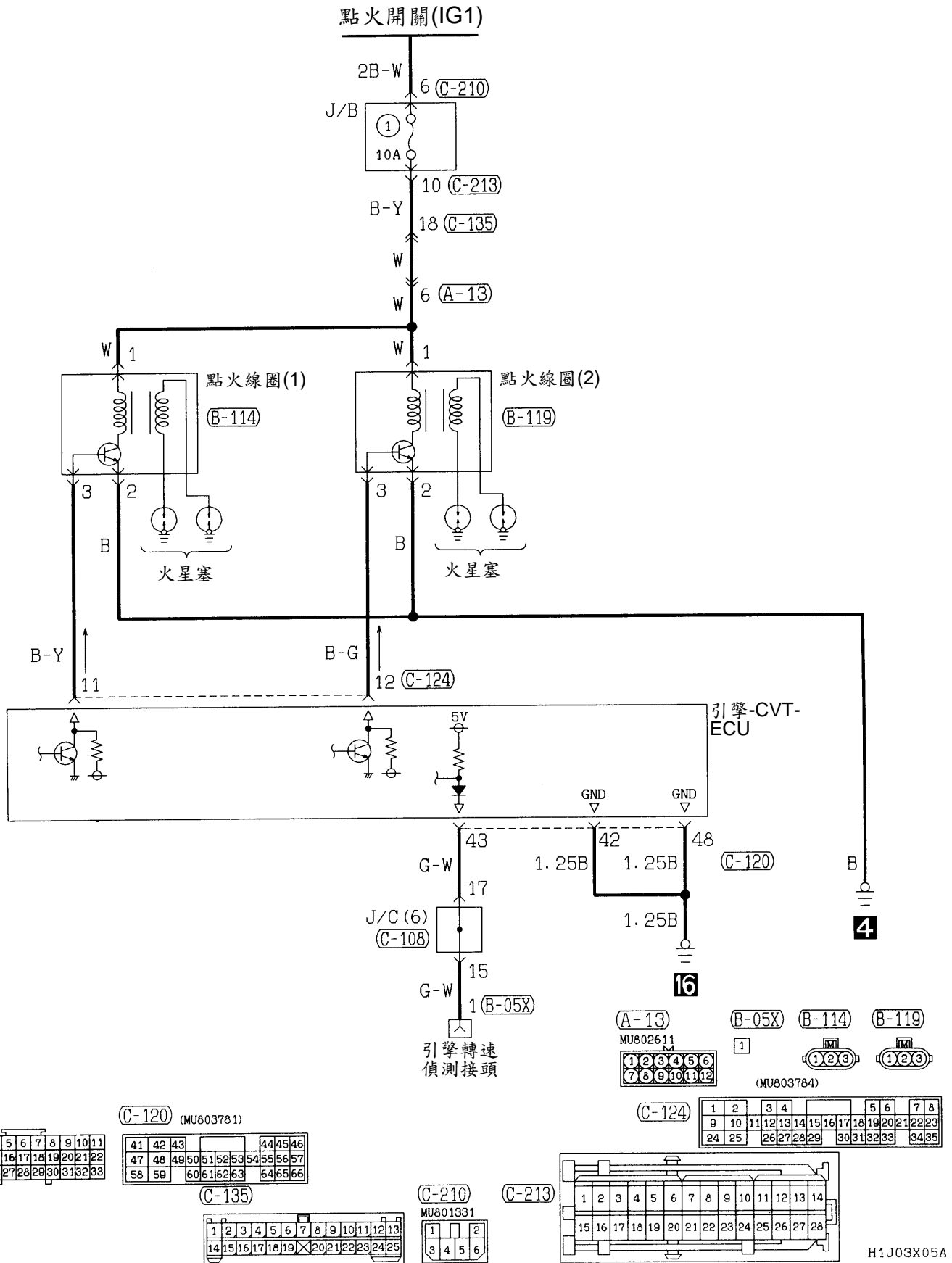

H1J03X05A

充電系統

1

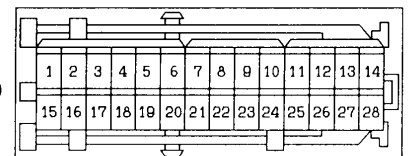
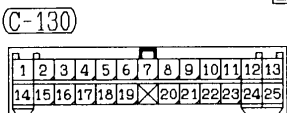
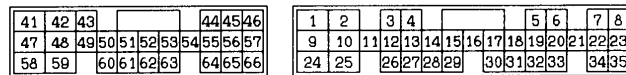
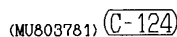
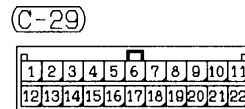
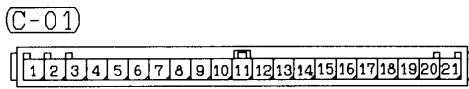
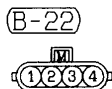
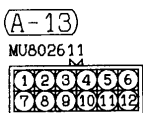
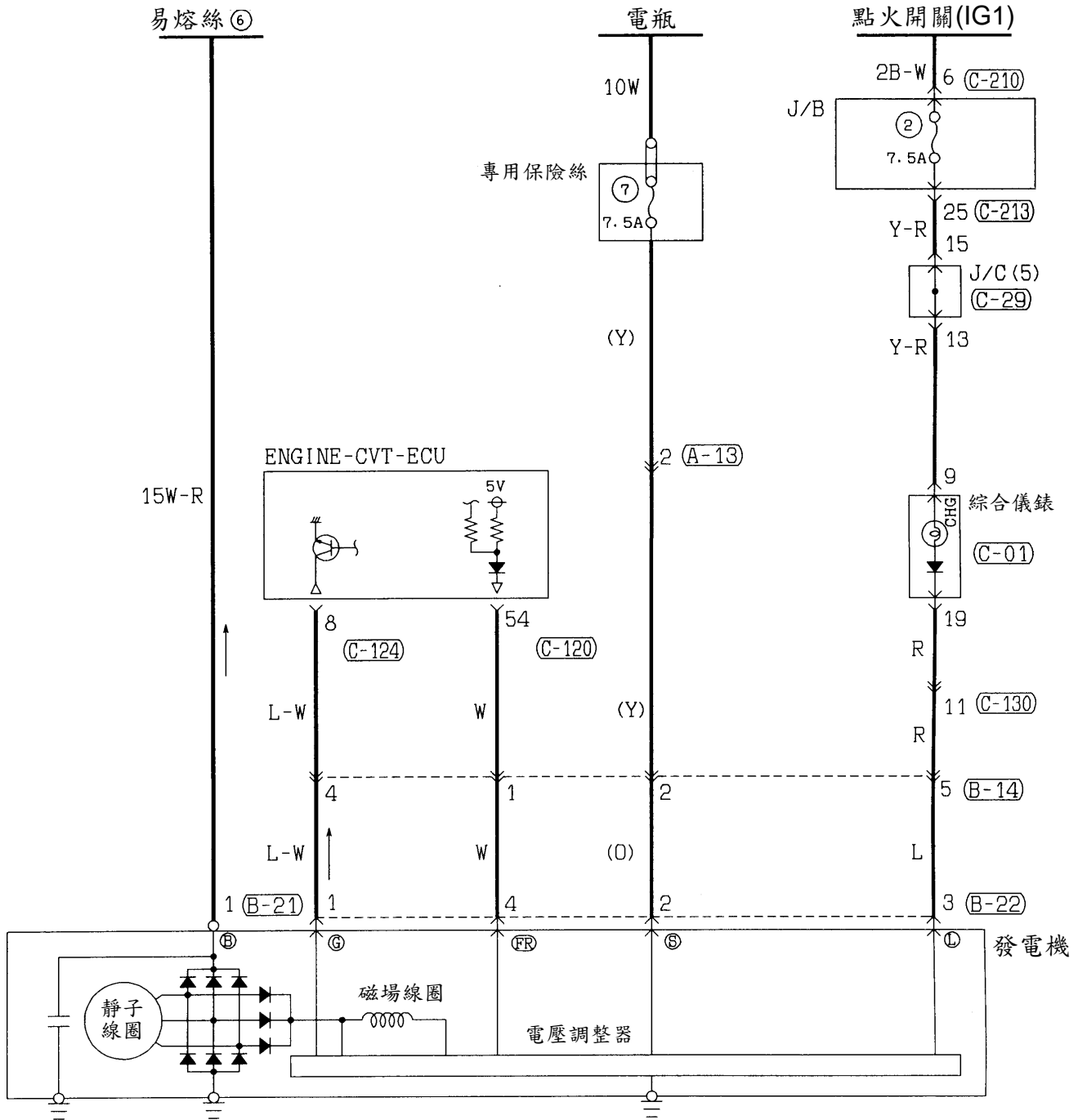

H1J04X03f

引擎控制系統
4G18引擎

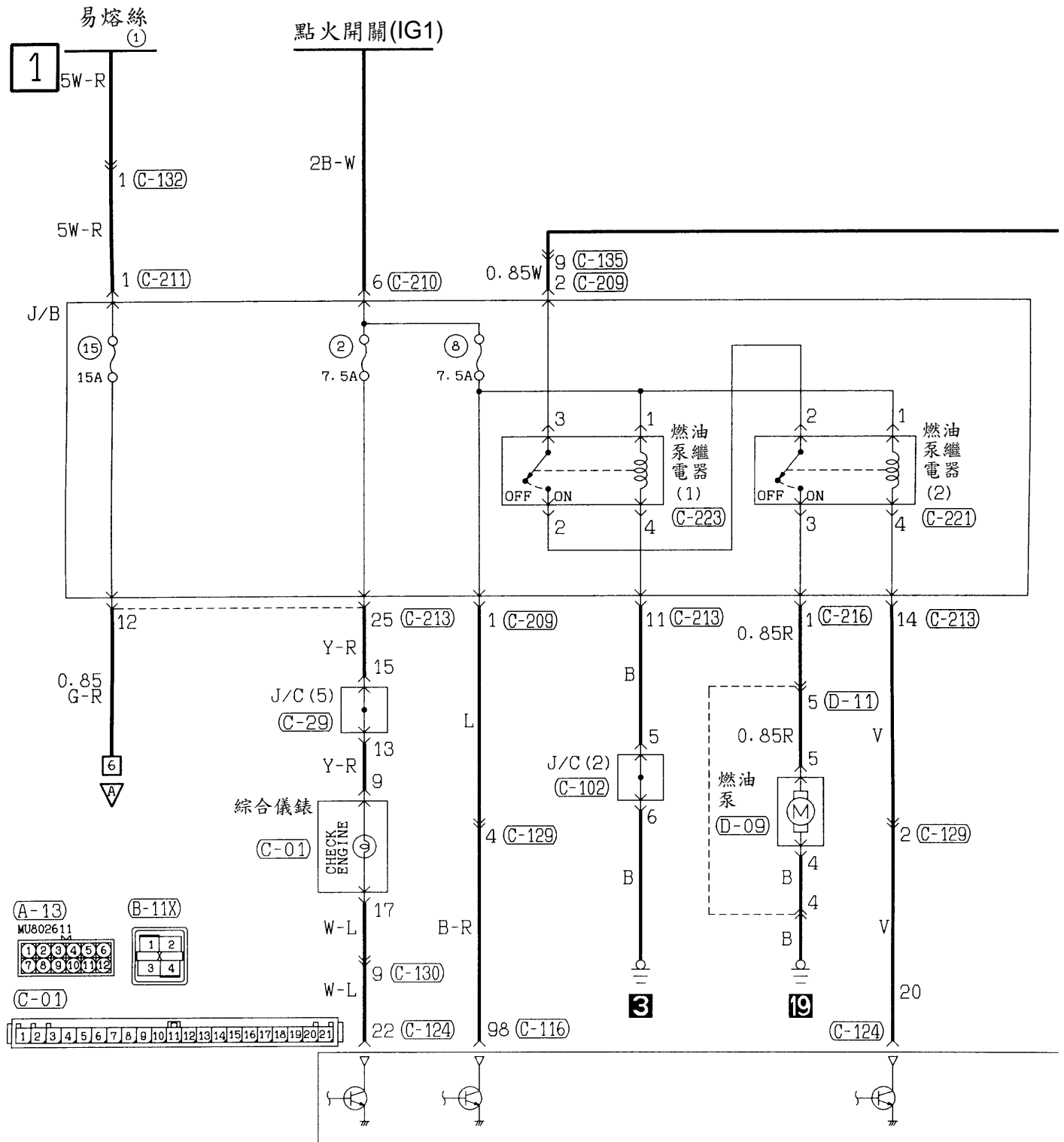

(C-05)

1	2	3	4	5	6	7	8	9	10	11
12	13	14	15	16	17	18	19	20	21	22

(C-29)

1	2	3	4	5	6	7	8	9	10	11
12	13	14	15	16	17	18	19	20	21	22

(C-102)

1	2	3	4	5	6	7	8	9	10	11
12	13	14	15	16	17	18	19	20	21	22

(C-108)

1	2	3	4	5	6	7	8	9	10	11
12	13	14	15	16	17	18	19	20	21	22
23	24	25	26	27	28	29	30	31	32	33

(C-116) (MU803782)

71	72	73	74	75	76	77
78	79	80	81	82	83	84
85	86	87	88	89	90	91
92	93	94	95	96	97	98

(C-130)

1	2	3	4	5	6	7	8	9	10	11	12	13
14	15	16	17	18	19	20	21	22	23	24	25	

(C-132) (MU801380)

1	2	3
---	---	---

(C-135)

1	2	3	4	5	6	7	8	9	10	11	12	13
14	15	16	17	18	19	20	21	22	23	24	25	

(C-209) MU801857

1	2	3	4	5	6
7	8	9	10	11	12
13	14				

(C-210) MU801331

1	2	3	4	5	6
---	---	---	---	---	---

(C-211)

1	2	3	4	5	6
---	---	---	---	---	---

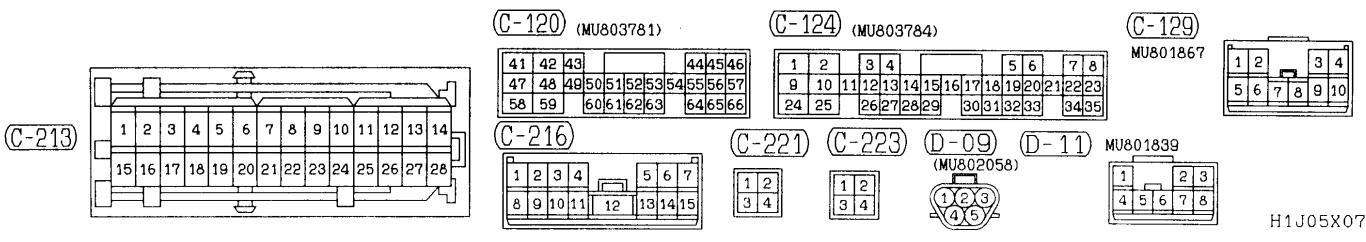
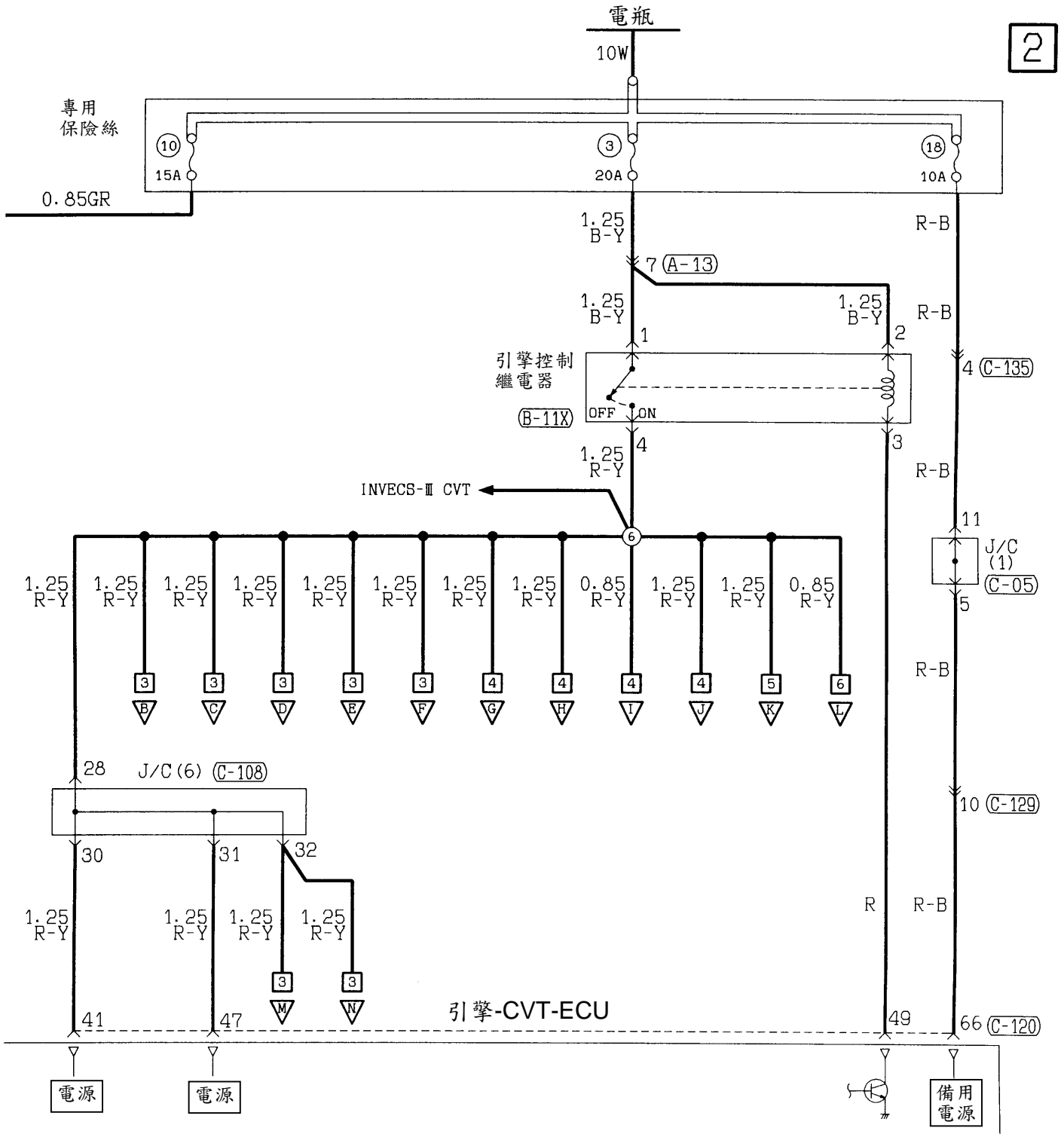

引擎控制系統
4G18引擎(續)

3

引擎控制幾電器

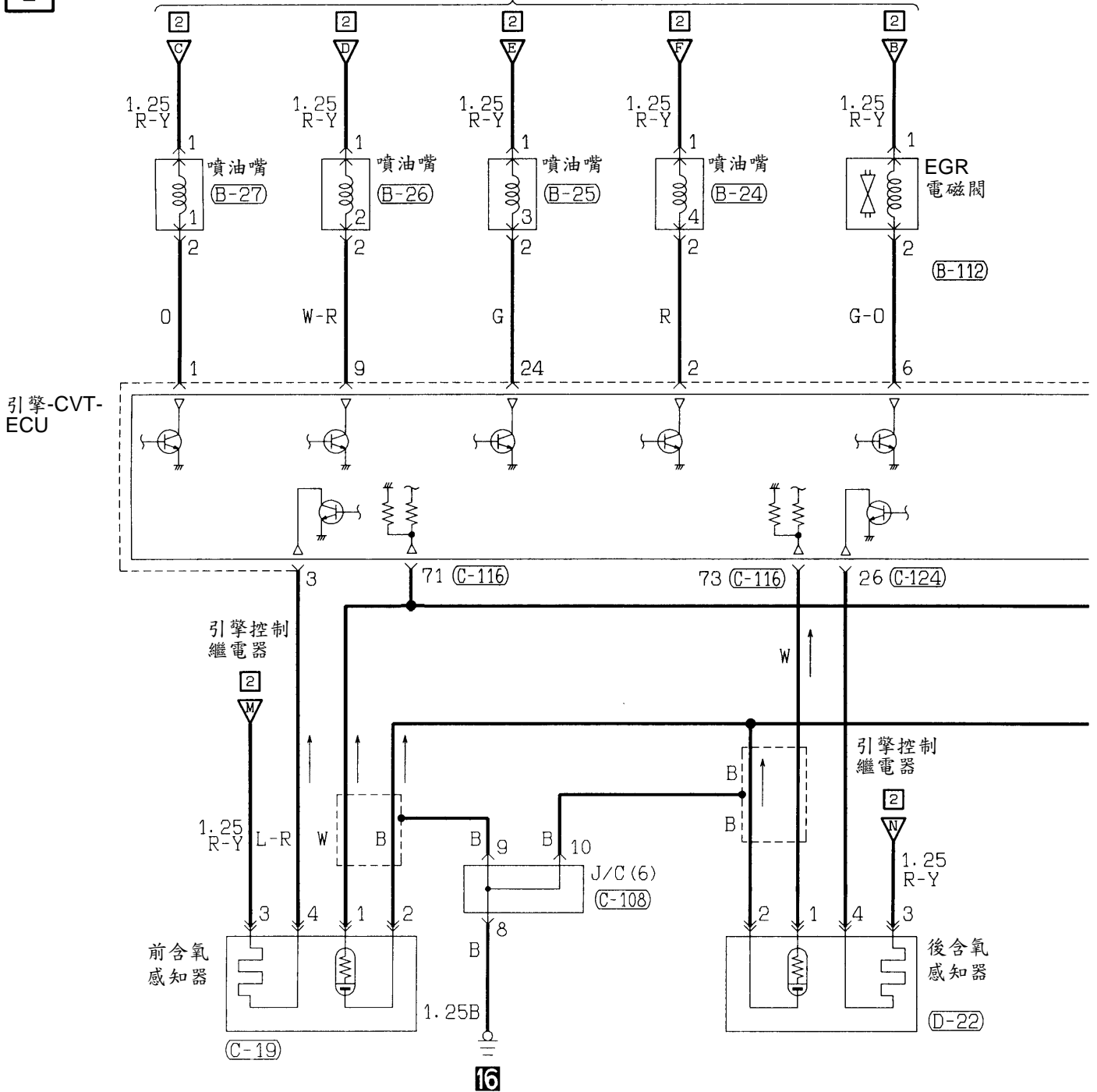

- (B-02)
(MU802078)
- (B-24)
- (B-25)
- (B-26)
- (B-27)
- (B-112)
- (B-113)
- (B-115)
- (B-116)
MU802337
- (B-117)
(MU802074)
- (B-118)
(MU802406)
- (B-121)
MU802603
- (C-19)
MU801446

引擎控制幾電器

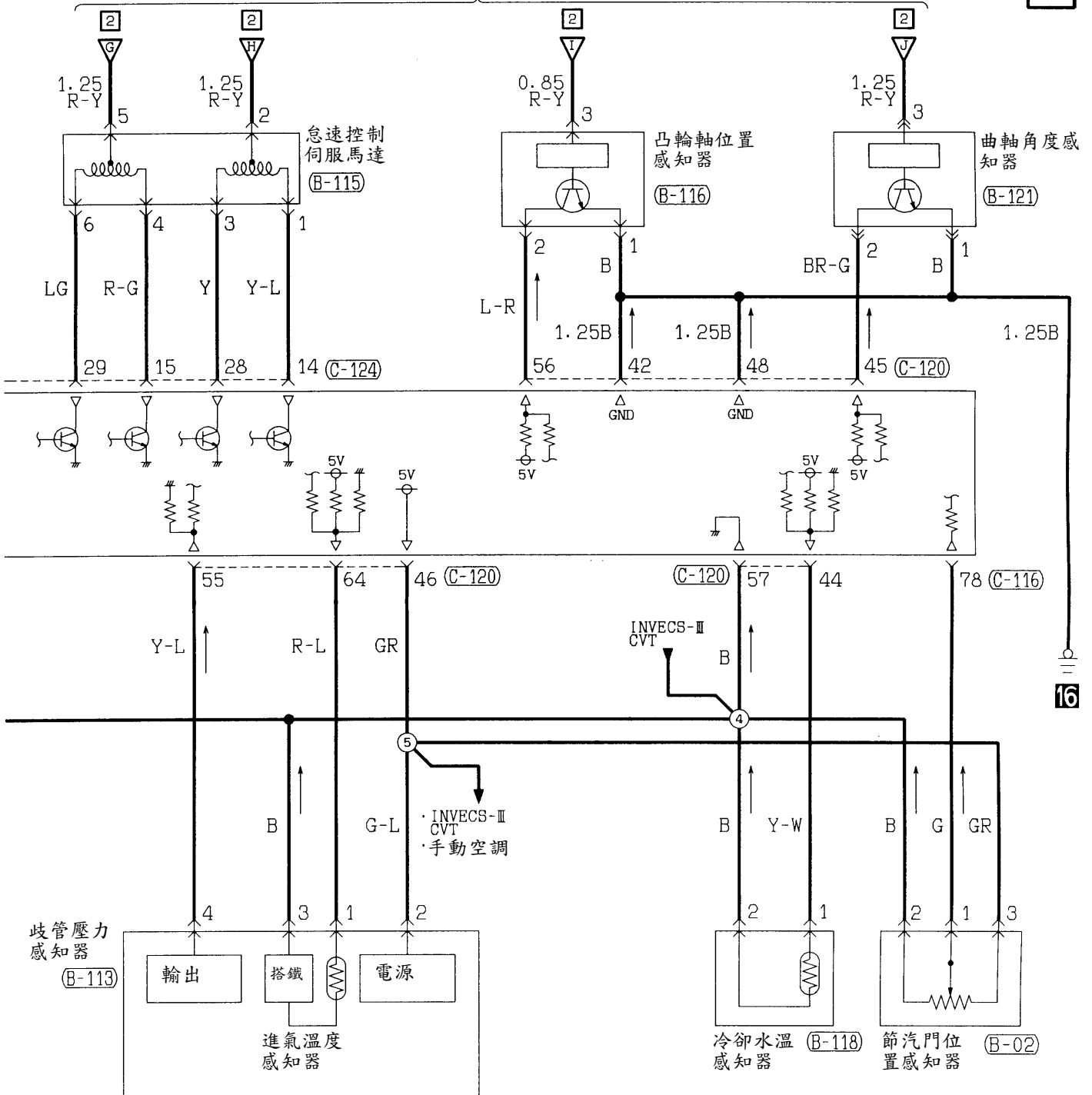

(C-108)

1	2	3	4	5	6	7	8	9	10	11
12	13	14	15	16	17	18	19	20	21	22
23	24	25	26	27	28	29	30	31	32	33

(C-116) (MU803782)

71	72	73	74			75	76	77			
78	79	80	81	82	83	84	85	86	87	88	89
90	91	92	93	94	95	96		97	98		

(C-120) (MU803781)

41	42	43				44	45	46		
47	48	49	50	51	52	53	54	55	56	57
58	59	60	61	62	63	64	65	66		

(C-124) (MU803784)

1	2	3	4			5	6	7	8					
9	10	11	12	13	14	15	16	17	18	19	20	21	22	23
24	25	26	27	28	29	30	31	32	33	34	35			

(D-22)

MU801446

1	2	3	4
---	---	---	---

引擎控制系統 4G18引擎(續)

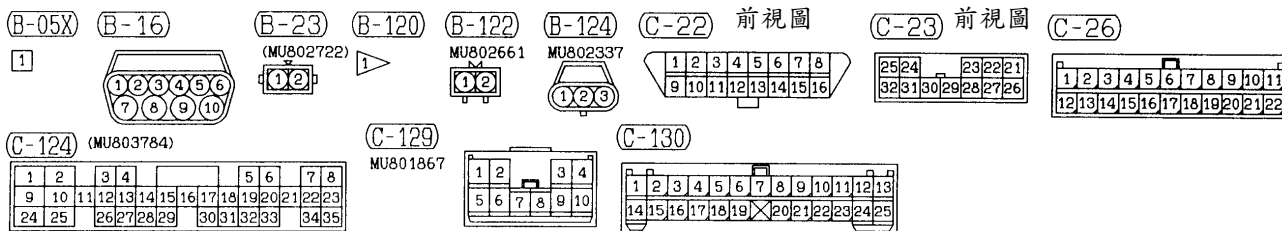
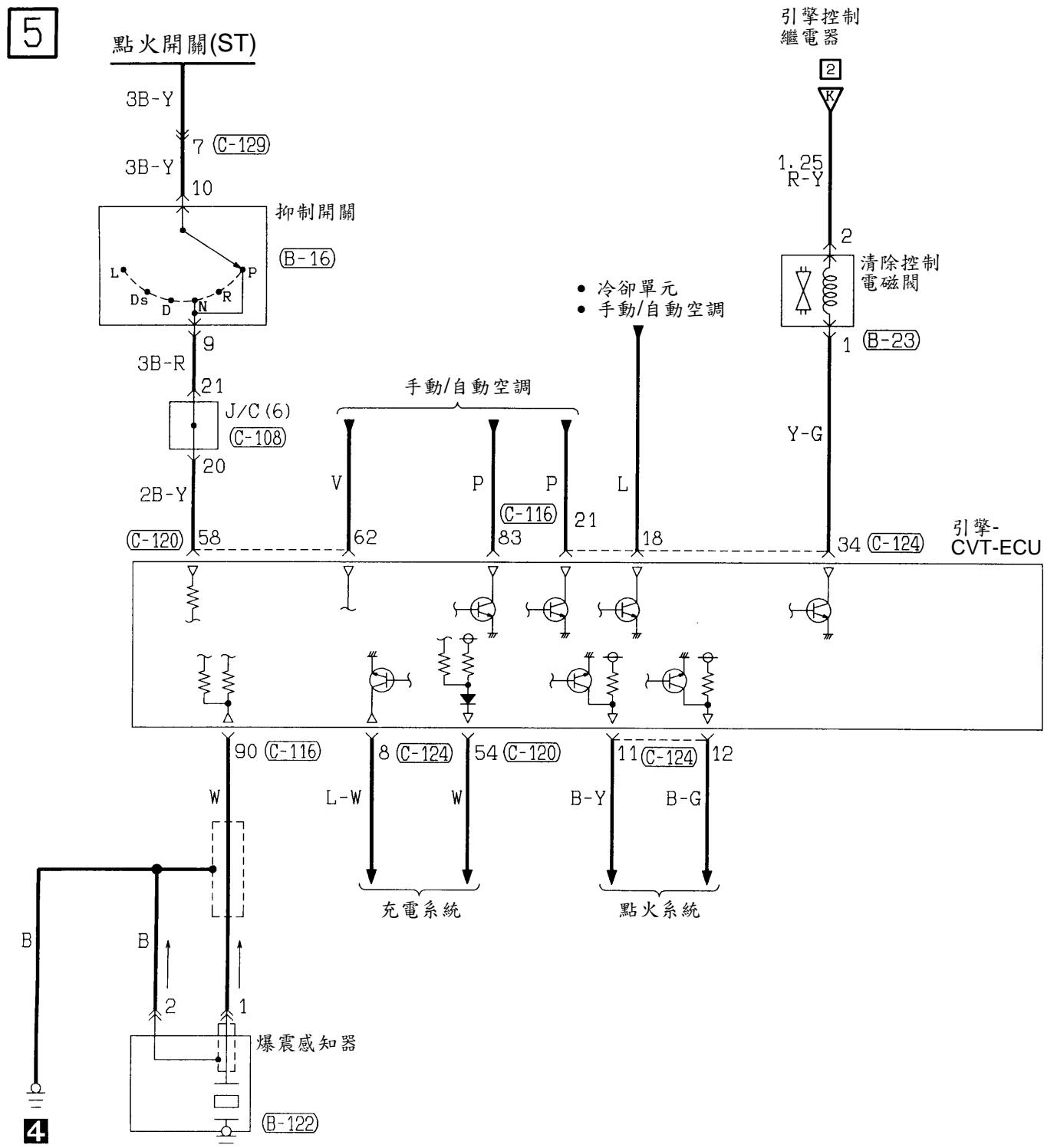

引擎-CVT-ECU

6

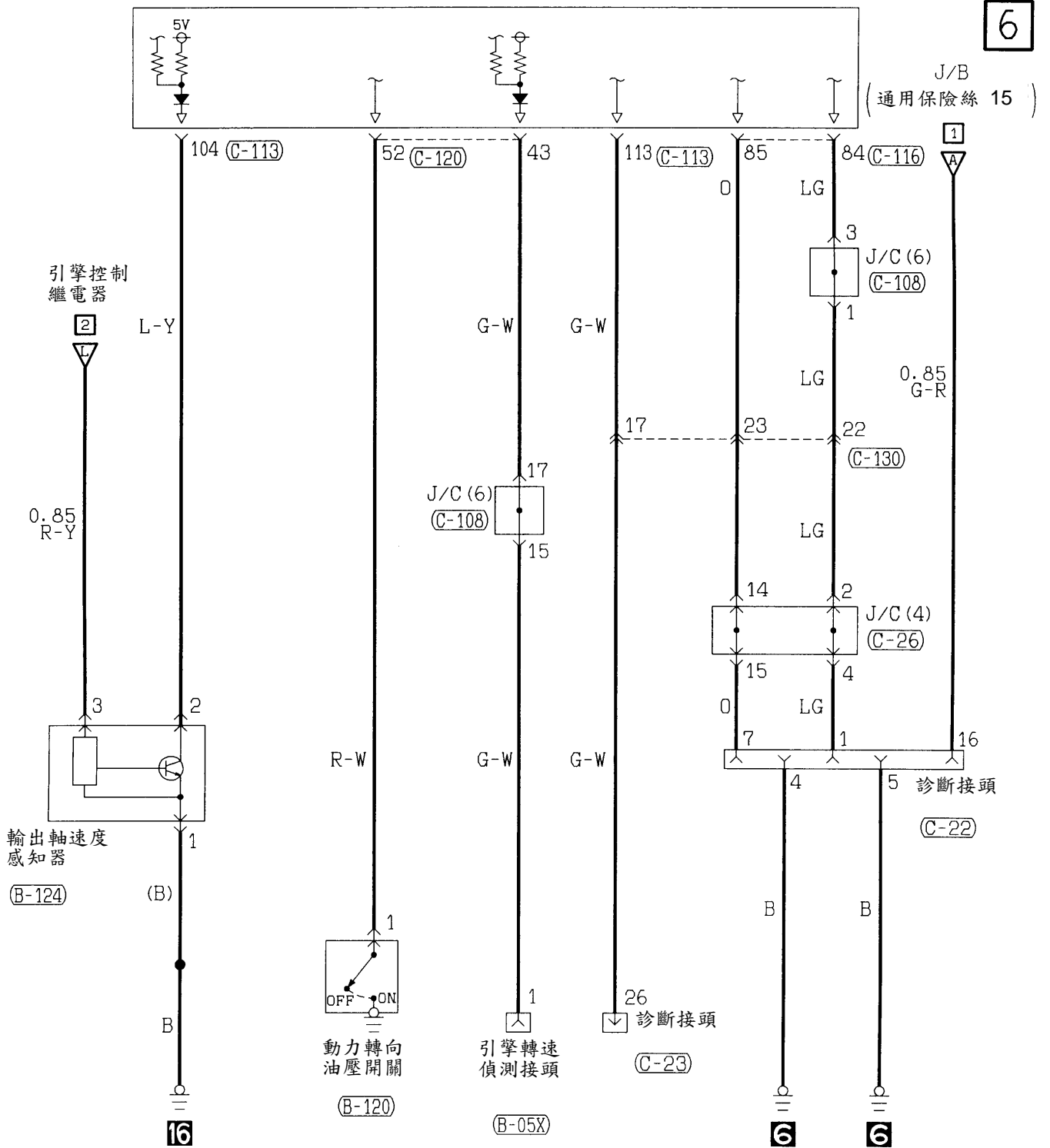

(C-108)

1	2	3	4	5	6	7	8	9	10	11
12	13	14	15	16	17	18	19	20	21	22
23	24	25	26	27	28	29	30	31	32	33

(C-113) (MU803783)

101	102	103	104			105	106	107
108	109	110	111	112	113	114	115	116
117	118	119	120			121	122	123
124	125	126	127	128		129	130	

(C-116) (MU803782)

71	72	73	74			75	76	77
78	79	80	81	82	83	84	85	86
87	88	89				90	91	92
93	94	95	96			97	98	

(C-120) (MU803781)

41	42	43				44	45	46
47	48	49	50	51	52	53	54	55
56	57					58	59	60
61	62	63				64	65	66

引擎控制系統
4G93 引擎

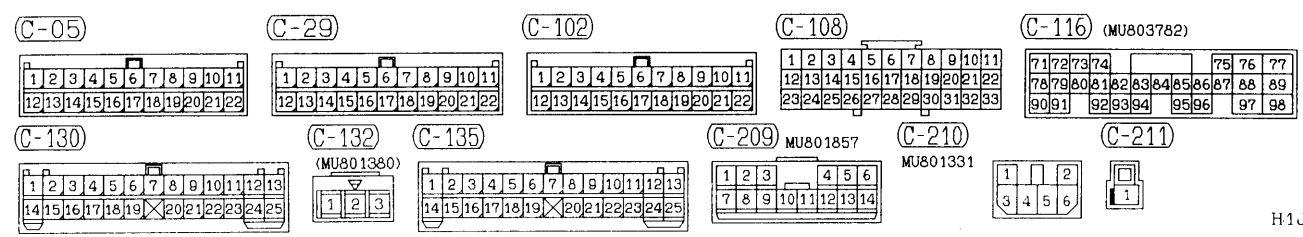
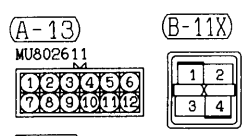
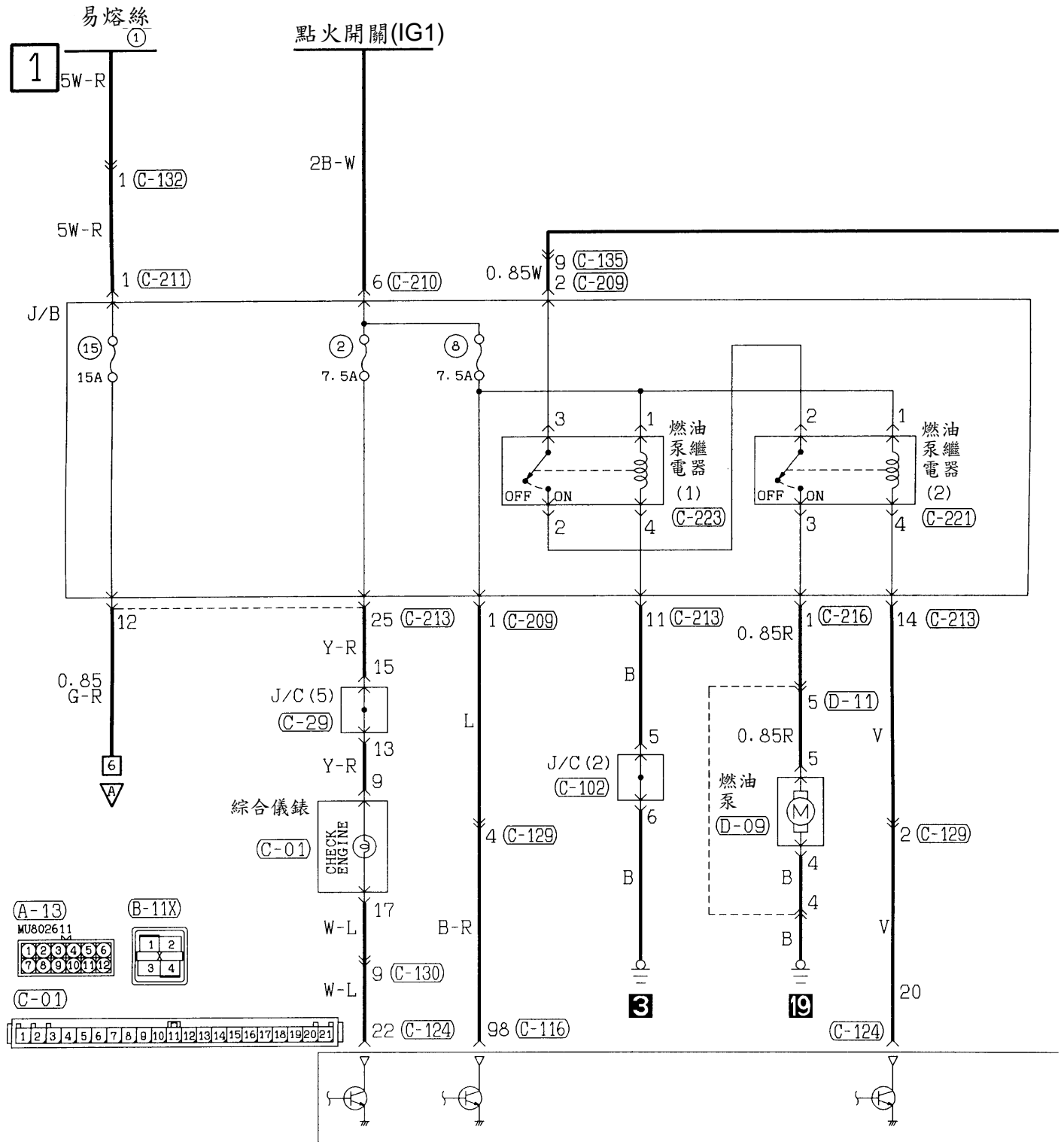

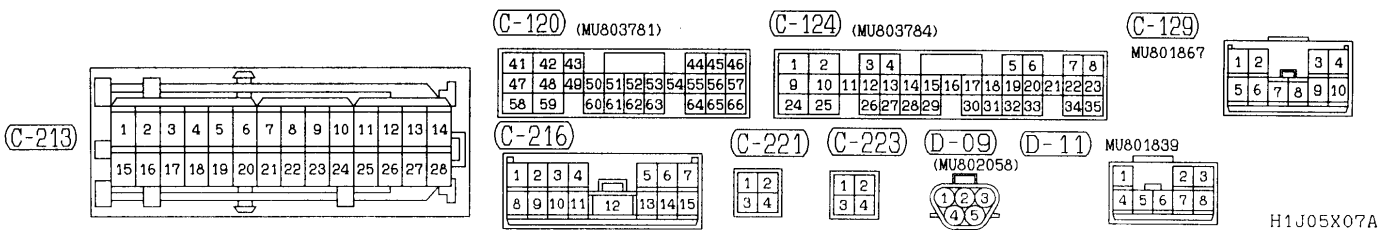
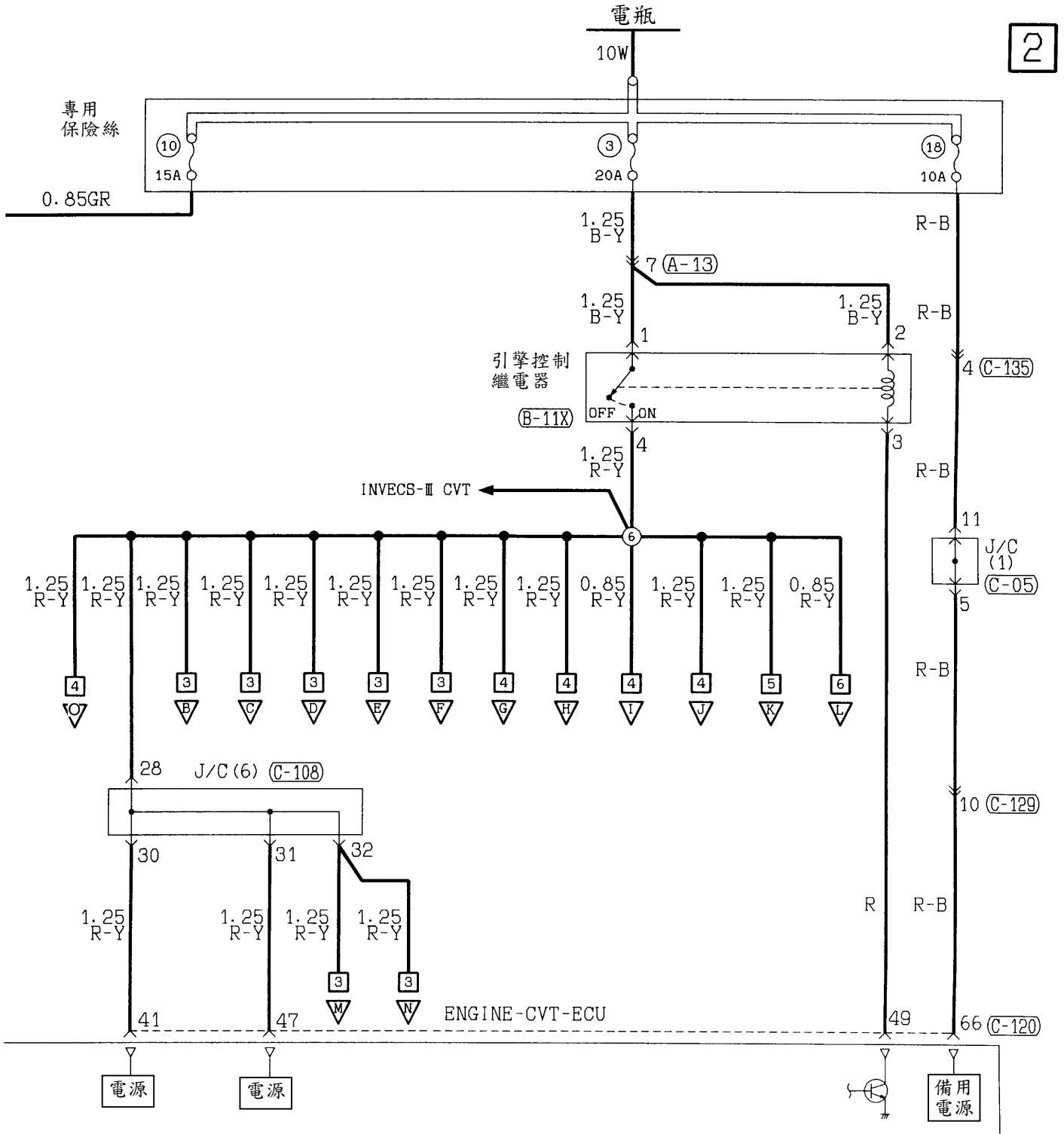

引擎控制系統
4G93 引擎(續)

3

引擎控制幾電器

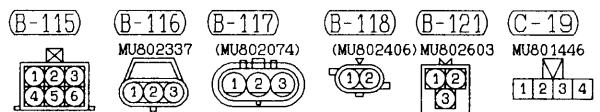
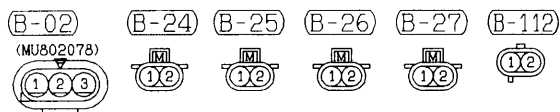
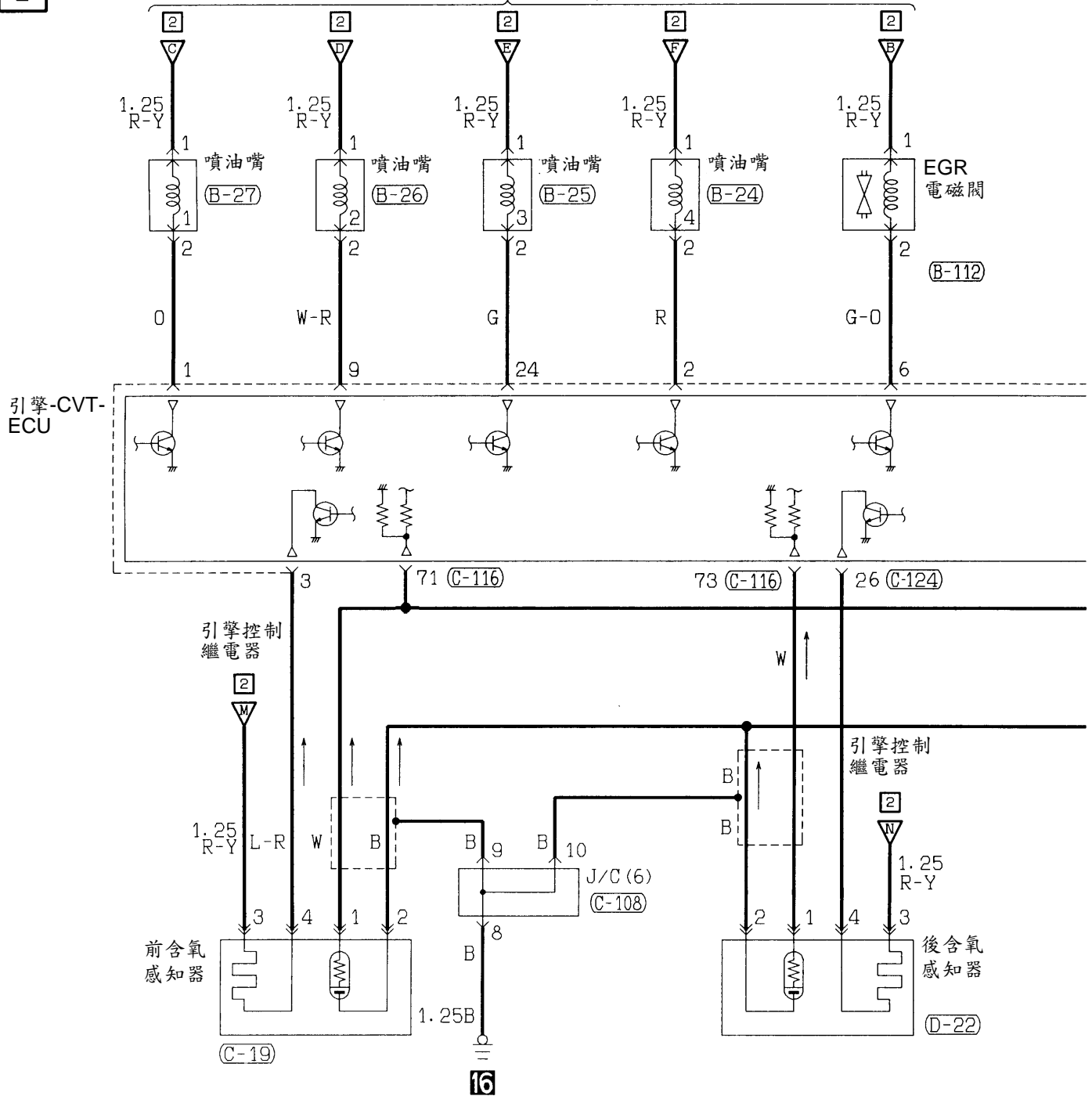

引擎控制幾電器

4

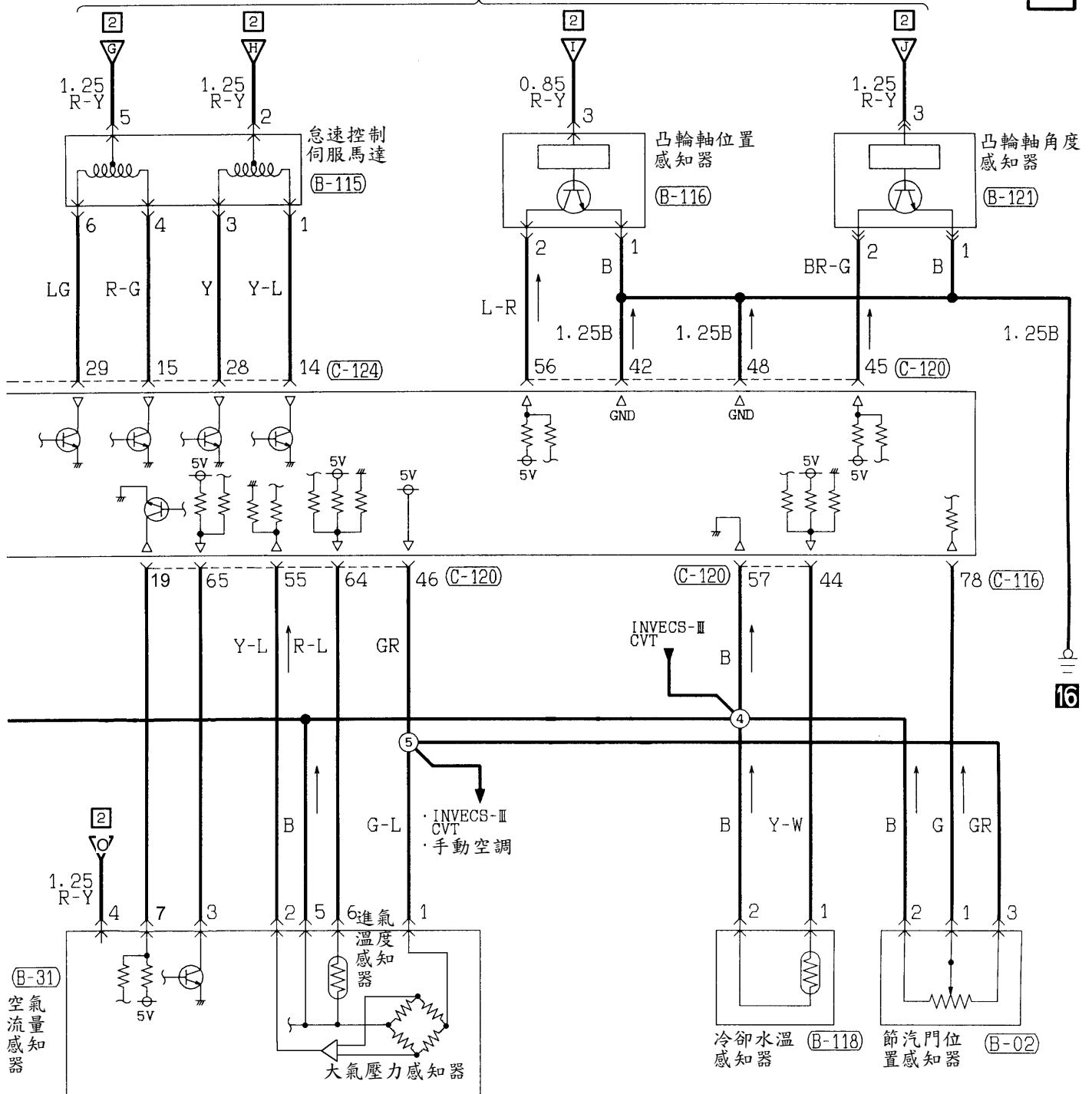

(C-108)

1	2	3	4	5	6	7	8	9	10	11
12	13	14	15	16	17	18	19	20	21	22
23	24	25	26	27	28	29	30	31	32	33

(C-116) (MU803782)

71	72	73	74			75	76	77			
78	79	80	81	82	83	84	85	86	87	88	89
90	91	92	93	94	95	96		97	98		

(C-120) (MU803781)

41	42	43				44	45	46		
47	48	49	50	51	52	53	54	55	56	57
58	59	60	61	62	63	64	65	66		

(C-124) (MU803784)

1	2	3	4			5	6	7	8					
9	10	11	12	13	14	15	16	17	18	19	20	21	22	23
24	25	26	27	28	29	30	31	32	33	34	35			

(D-22)

MU801446

1	2	3	4
---	---	---	---

引擎控制系統

4G93 引擎(續)

5

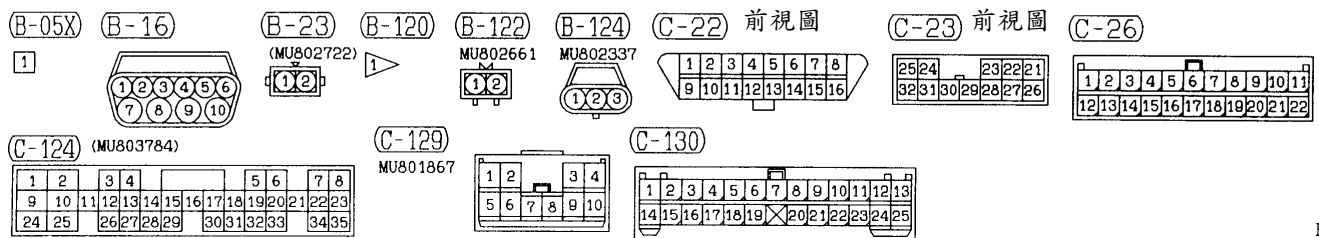
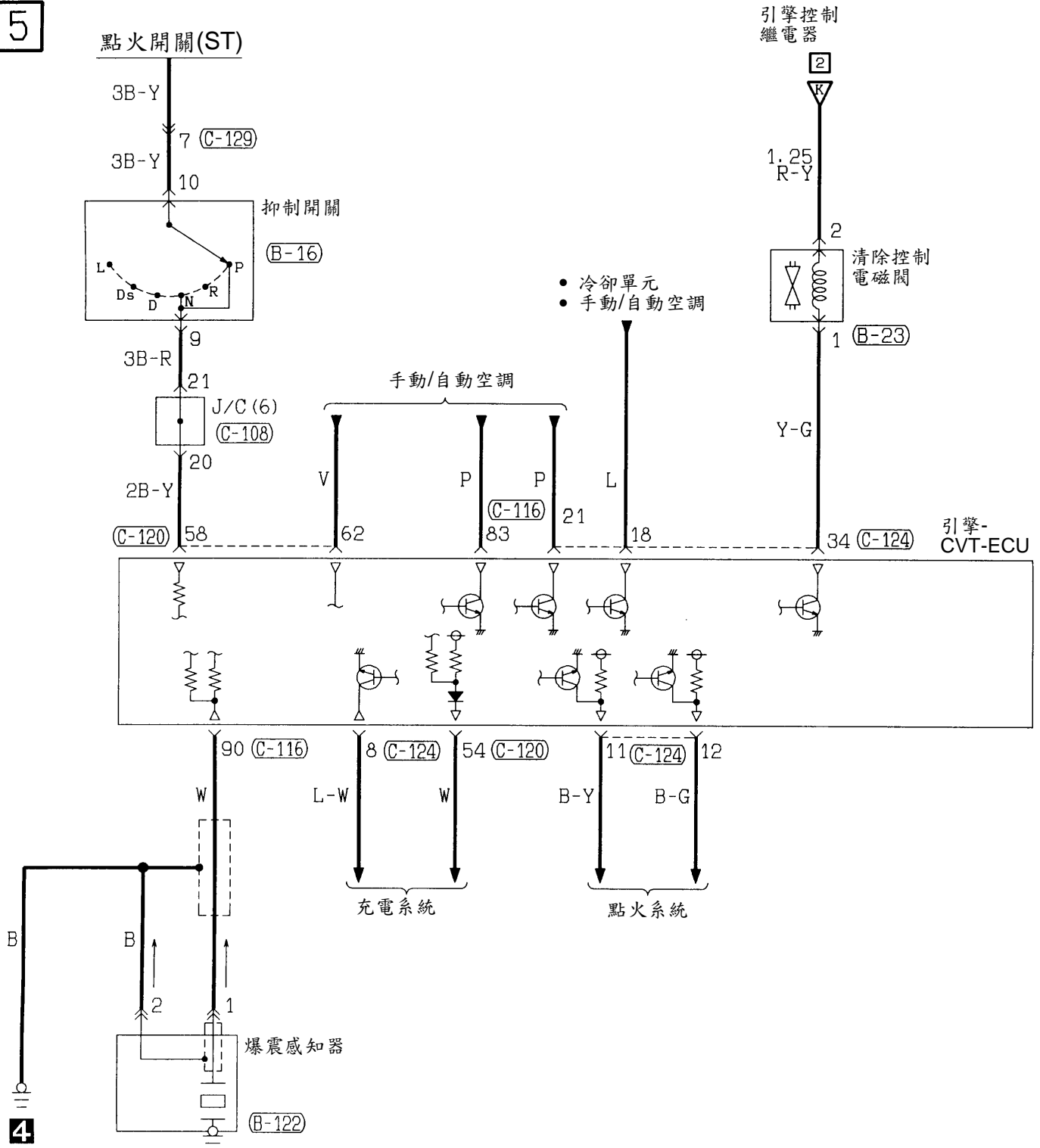

引擎-CVT-ECU

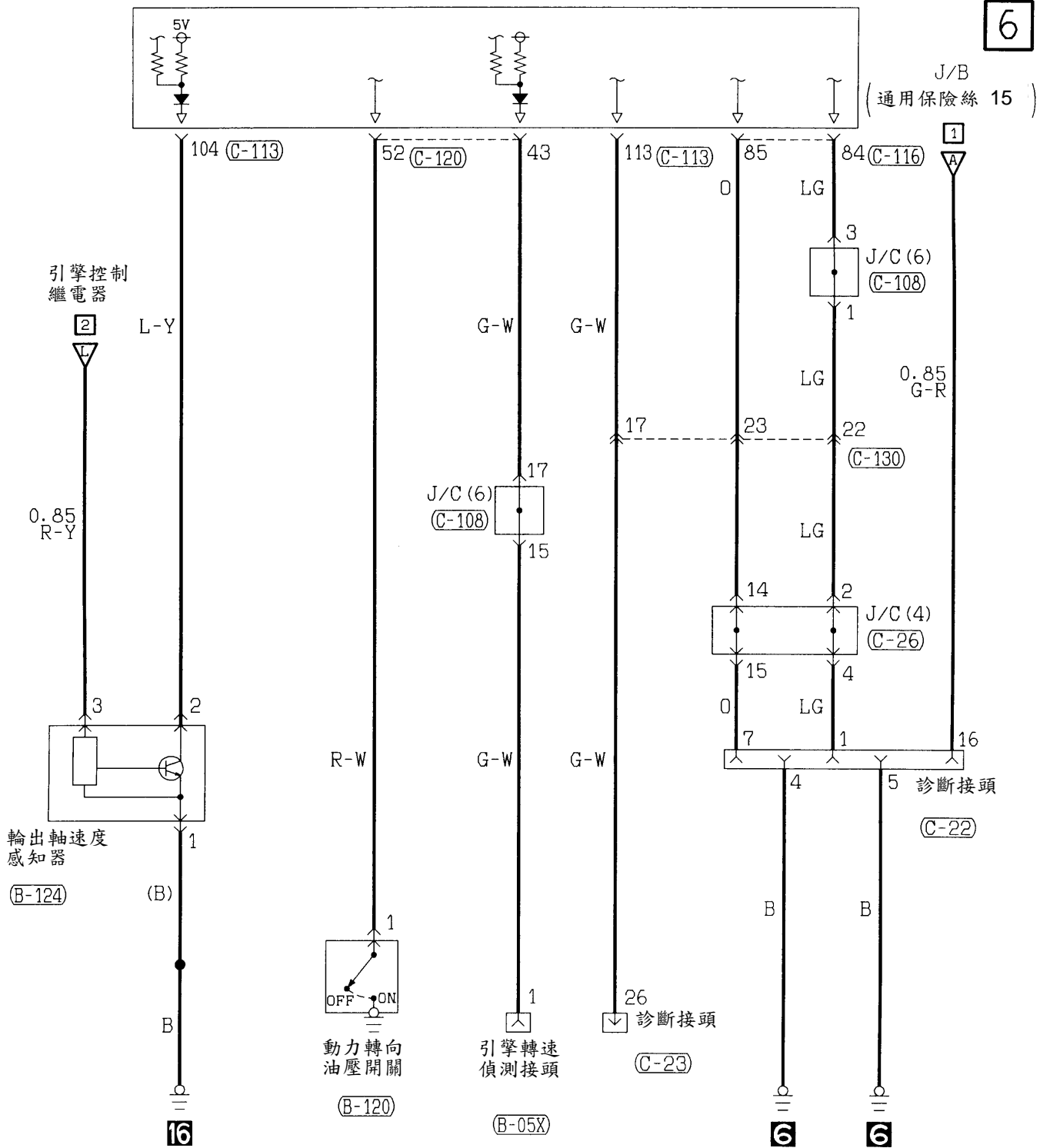

(C-108)

1	2	3	4	5	6	7	8	9	10	11
12	13	14	15	16	17	18	19	20	21	22
23	24	25	26	27	28	29	30	31	32	33

(C-113) (MU803783)

101	102	103	104			105	106	107				
108	109	110	111	112	113	114	115	116	117	118	119	120
121	122	123	124	125	126	127	128	129	130			

(C-116) (MU803782)

71	72	73	74			75	76	77			
78	79	80	81	82	83	84	85	86	87	88	89
90	91	92	93	94	95	96	97	98			

(C-120) (MU803781)

41	42	43				44	45	46		
47	48	49	50	51	52	53	54	55	56	57
58	59	60	61	62	63	64	65	66		

冷卻系統

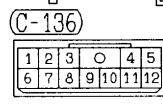
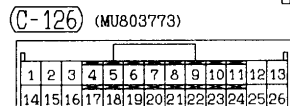
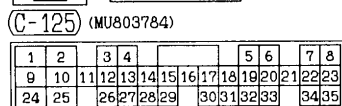
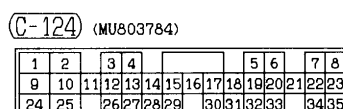
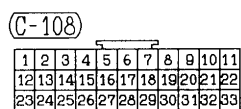
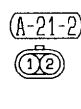
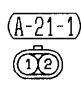
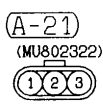
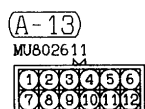
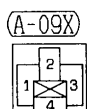
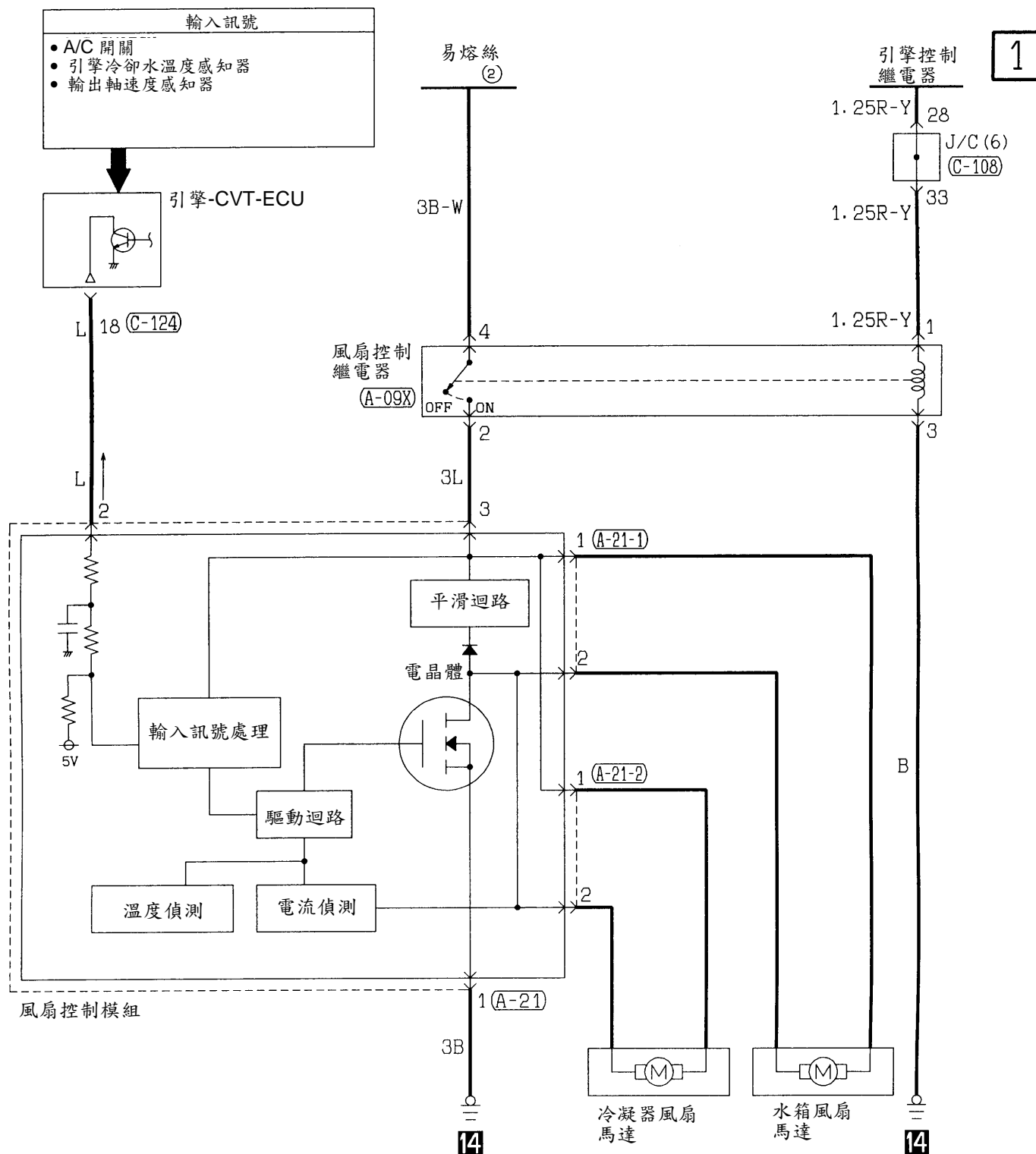

INVECS-III CVT

1

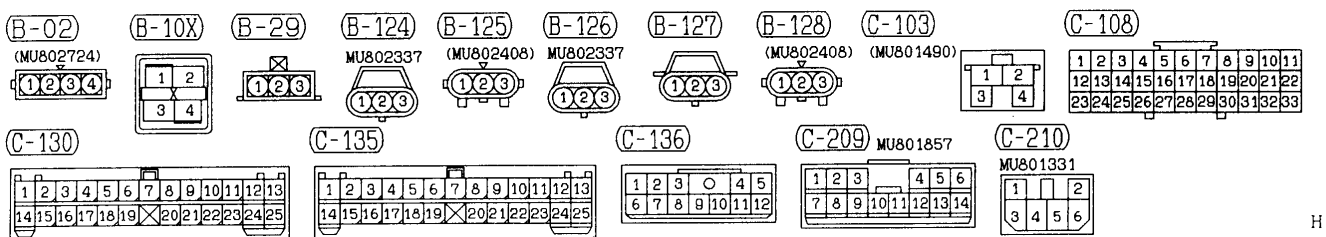
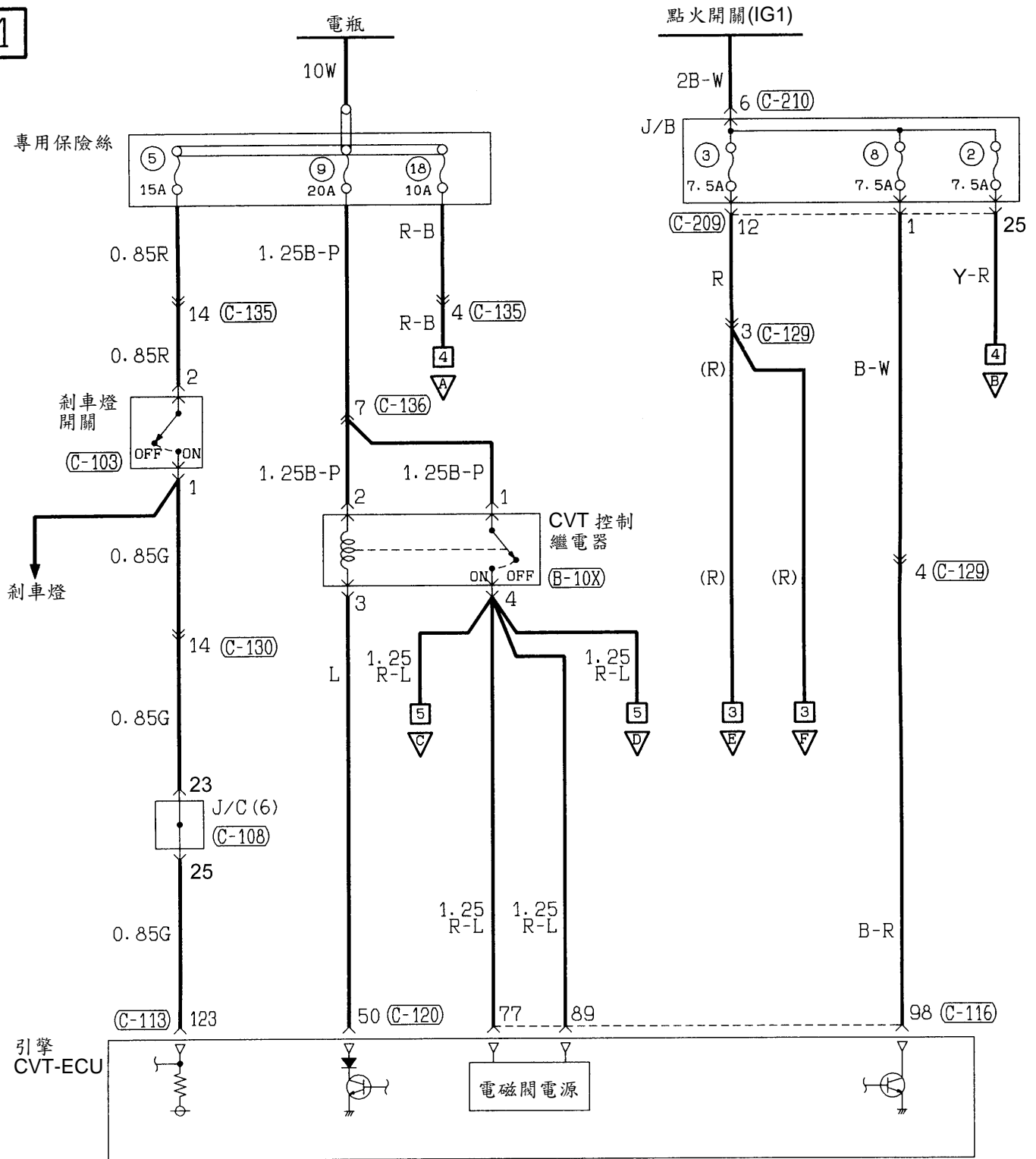

INVECS-III CVT(續)

2

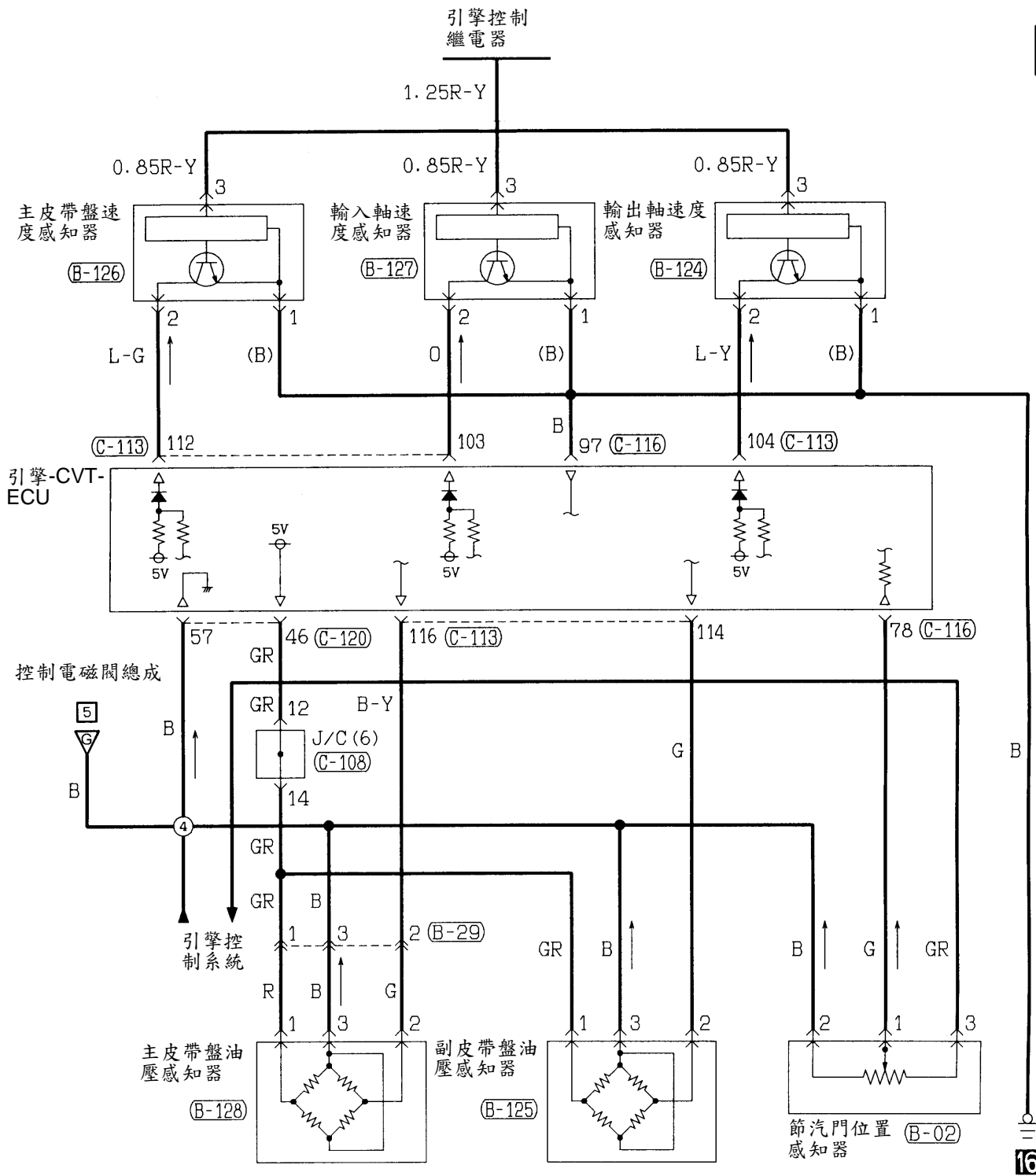

(C-108)

1	2	3	4	5	6	7	8	9	10	11
12	13	14	15	16	17	18	19	20	21	22
23	24	25	26	27	28	29	30	31	32	33

(C-113) (MU803783)

101	102	103	104	105	106	107						
108	109	110	111	112	113	114	115	116	117	118	119	120
121	122	123	124	125	126	127	128	129	130			

(C-116) (MU803782)

71	72	73	74	75	76	77					
78	79	80	81	82	83	84	85	86	87	88	89
90	91	92	93	94	95	96	97	98			

(C-135)

1	2	3	4	5	6	7	8	9	10	11	12	13
14	15	16	17	18	19	20	21	22	23	24	25	

(C-209) MU801857

1	2	3	4	5	6		
7	8	9	10	11	12	13	14

(C-213)

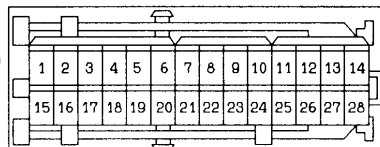

(D-16)



INVECS-III CVT(續)

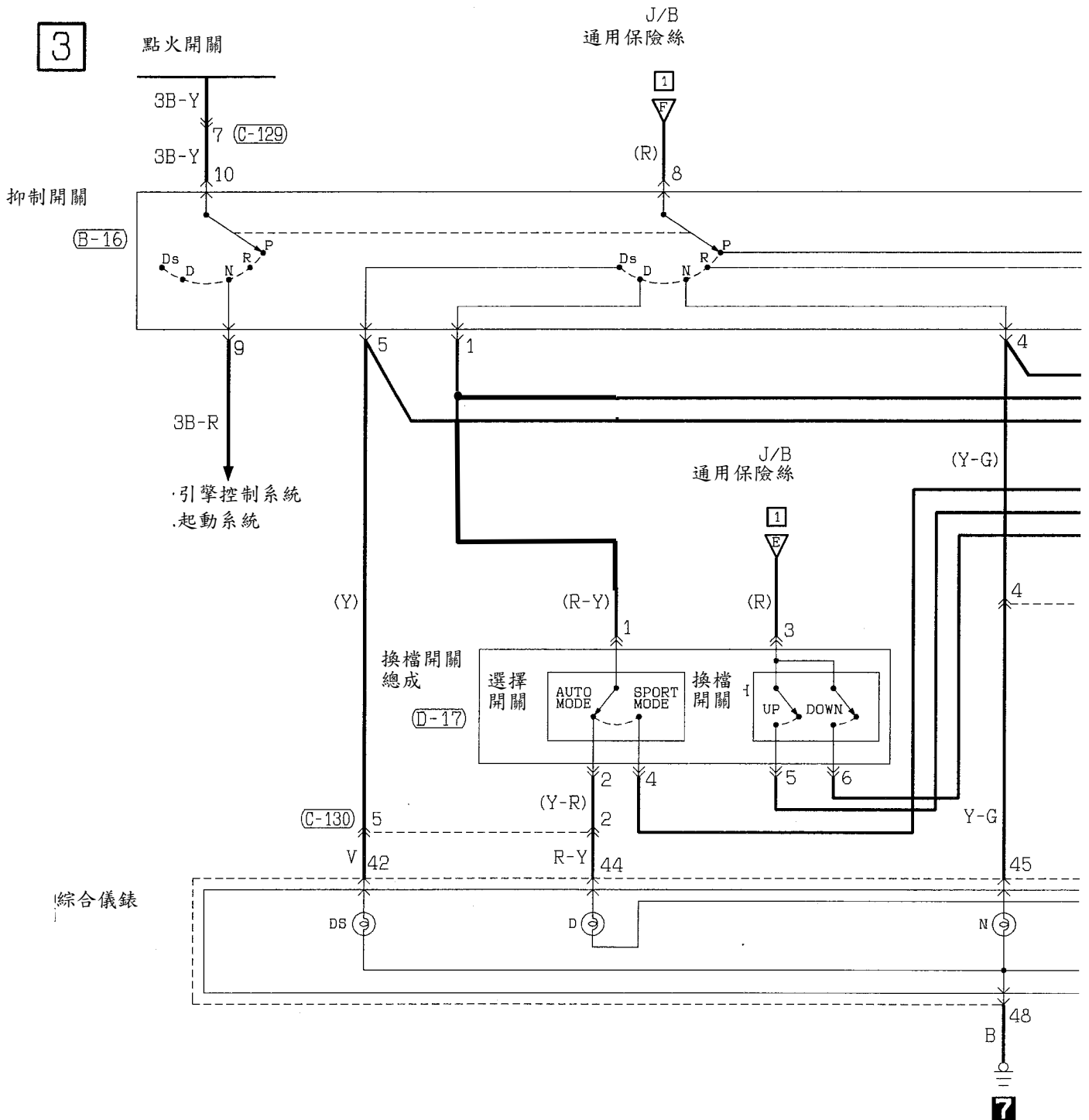

(B-16) MU802355

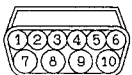

(C-01)

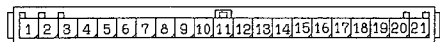

(C-02)

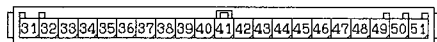

(C-128)

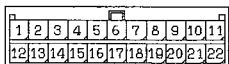

(C-129) MU801867

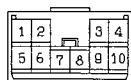

(C-130)

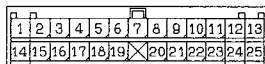

(D-17) MU801447



INVECS-III CVT(續)

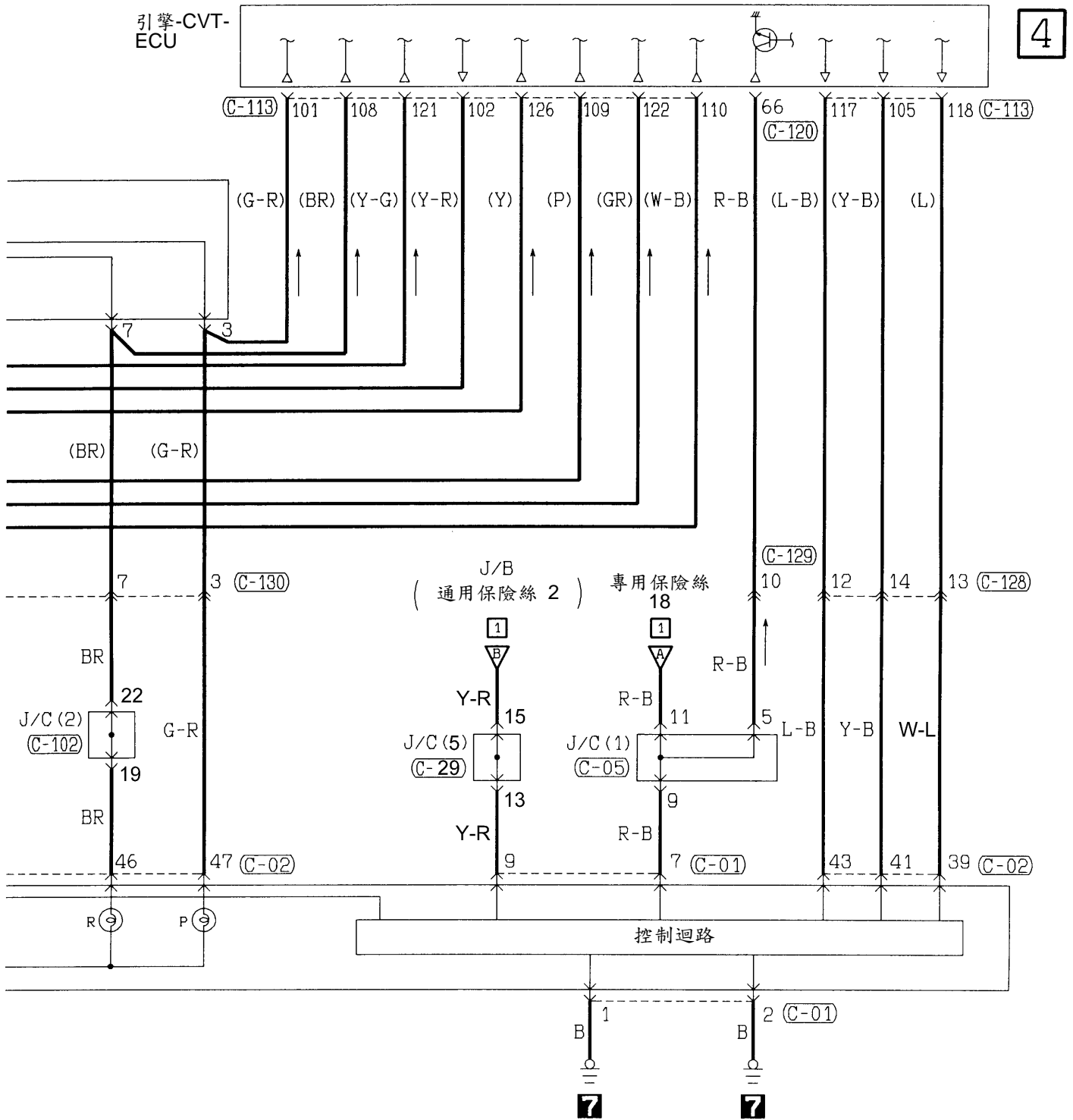

(C-05)

1	2	3	4	5	6	7	8	9	10	11
12	13	14	15	16	17	18	19	20	21	22

(C-102)

1	2	3	4	5	6	7	8	9	10	11
12	13	14	15	16	17	18	19	20	21	22

(C-108)

1	2	3	4	5	6	7	8	9	10	11
12	13	14	15	16	17	18	19	20	21	22
23	24	25	26	27	28	29	30	31	32	33

(C-113) (MU803783)

101	102	103	104	105	106	107
108	109	110	111	112	113	114
115	116	117	118	119	120	
121	122	123	124	125	126	127
128	129	130				

(C-120) (MU803781)

41	42	43				44	45	46
47	48	49	50	51	52	53	54	55
56	57							
58	59	60	61	62	63	64	65	66

INVECS-III CVT(續)

5

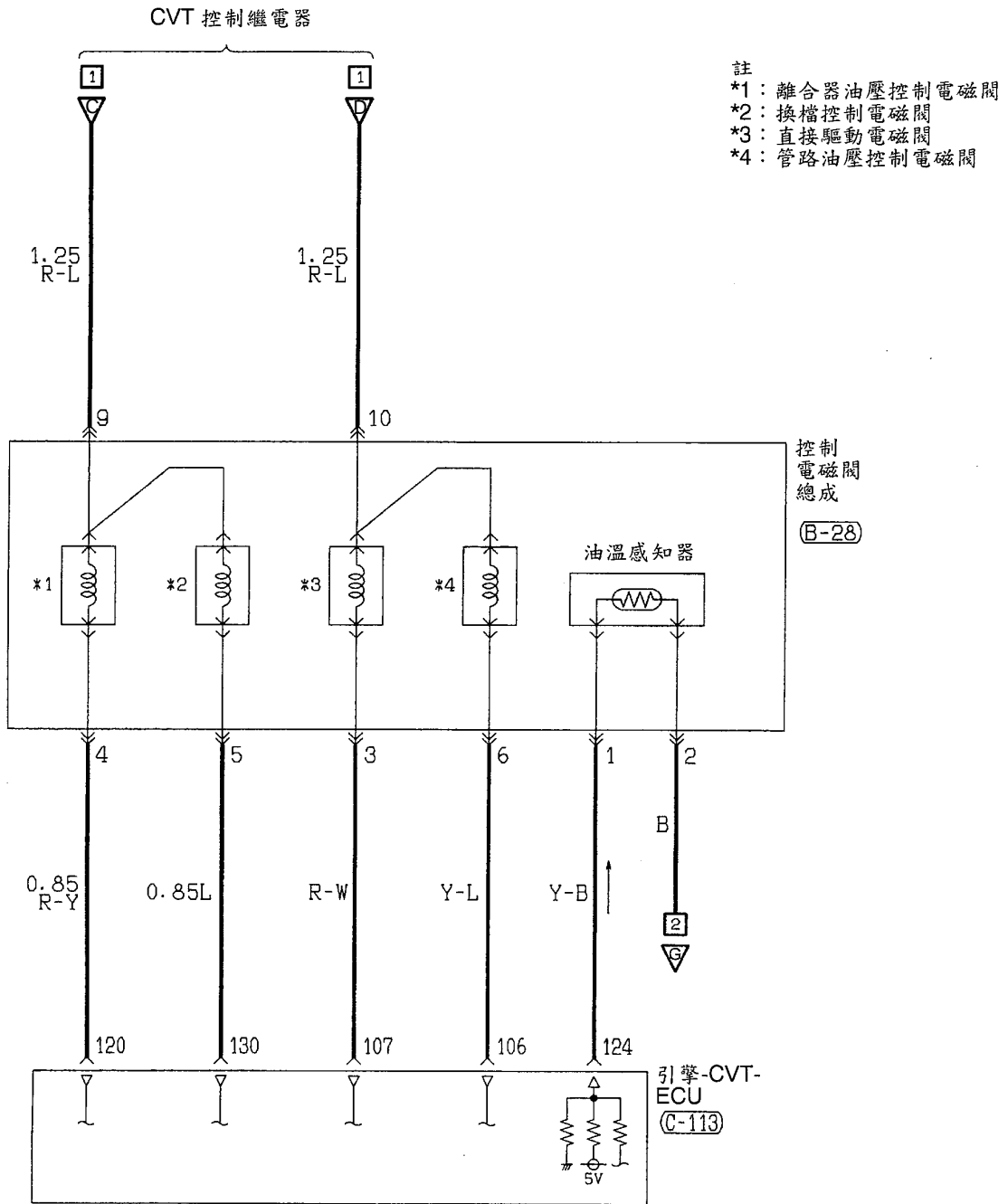

- 註
 *1: 離合器油壓控制電磁閥
 *2: 換檔控制電磁閥
 *3: 直接驅動電磁閥
 *4: 管路油壓控制電磁閥

控制電磁閥總成 (B-28)

引擎-CVT-ECU (C-113)

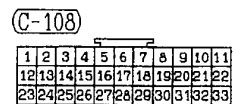
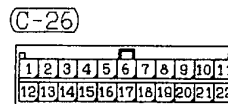
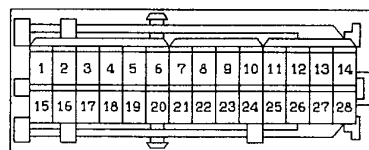
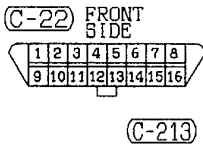
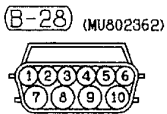

INVECS-III CVT(續)

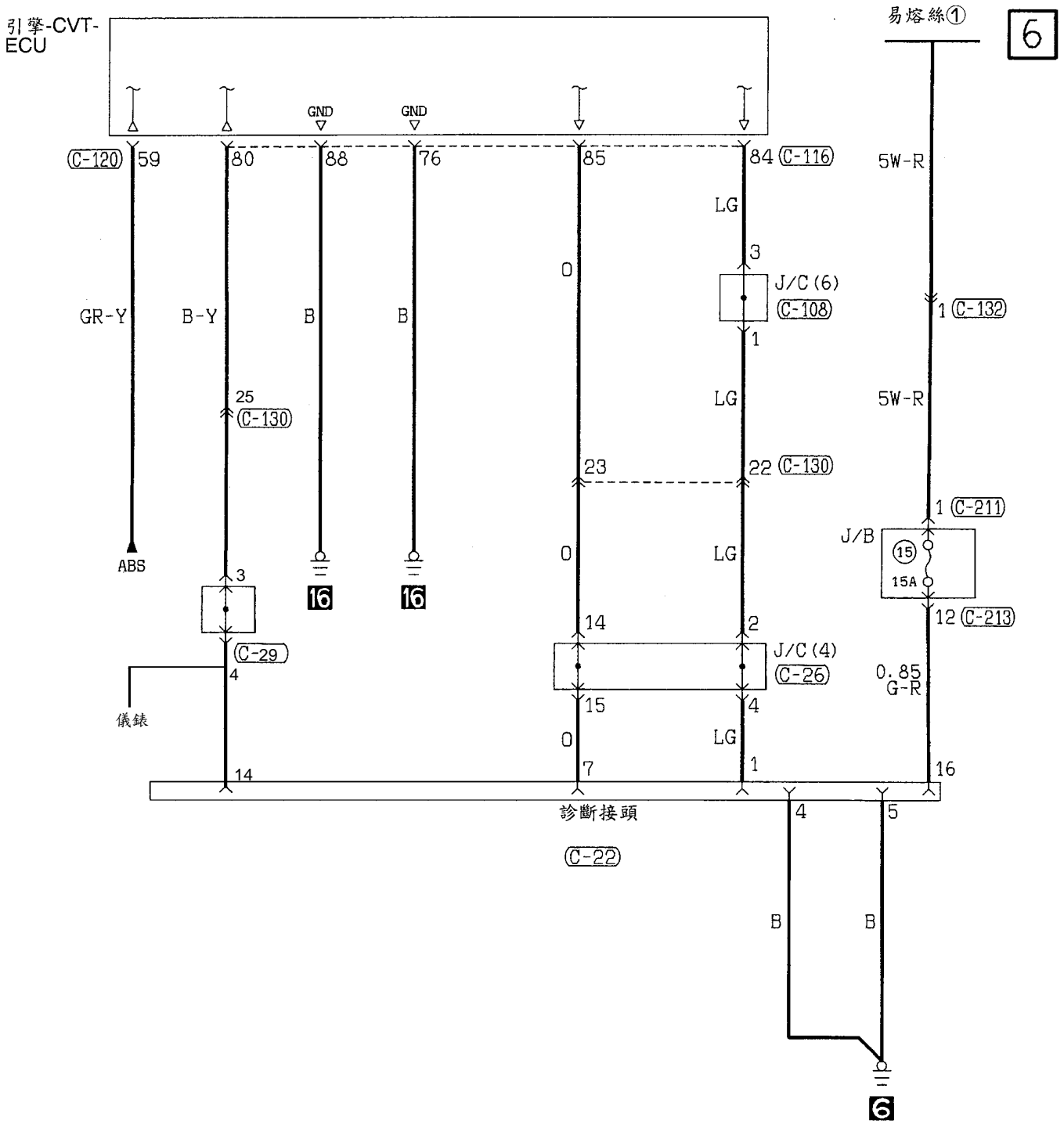

(C-113) (MU803783)

101	102	103	104		105	106	107					
108	109	110	111	112	113	114	115	116	117	118	119	120
121	122	123	124	125	126	127	128	129	130			

(C-116) (MU803782)

71	72	73	74		75	76	77				
78	79	80	81	82	83	84	85	86	87	88	89
90	91	92	93	94	95	96	97	98			

(C-130)

1	2	3	4	5	6	7	8	9	10	11	12	13
14	15	16	17	18	19	20	21	22	23	24	25	

(C-120) (MU803781)

41	42	43		44	45	46				
47	48	49	50	51	52	53	54	55	56	57
58	59	60	61	62	63	64	65	66		

(C-132) (MU801380)

1	2	3
---	---	---

(C-211)

1

頭燈

1

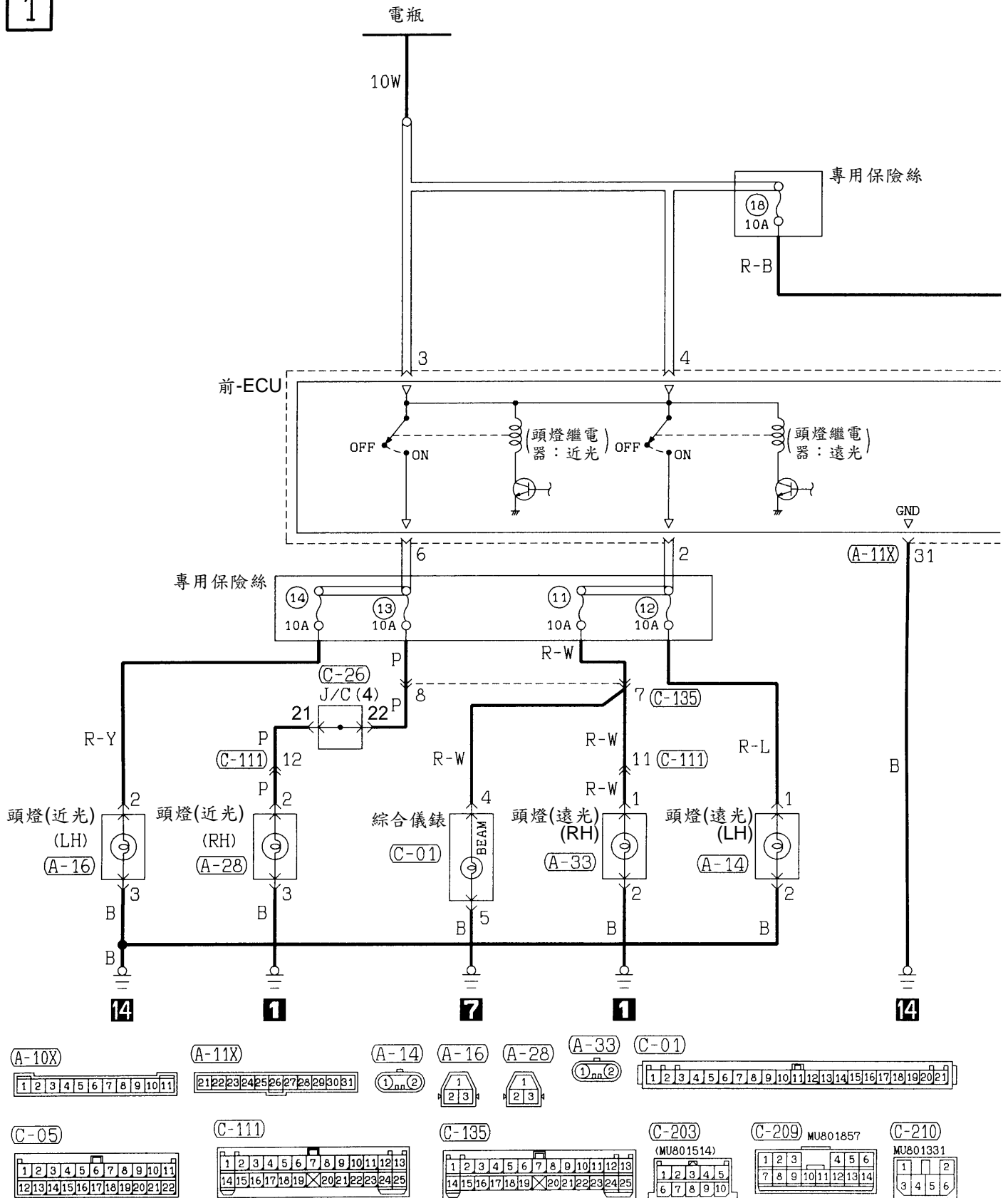

頭燈(續)

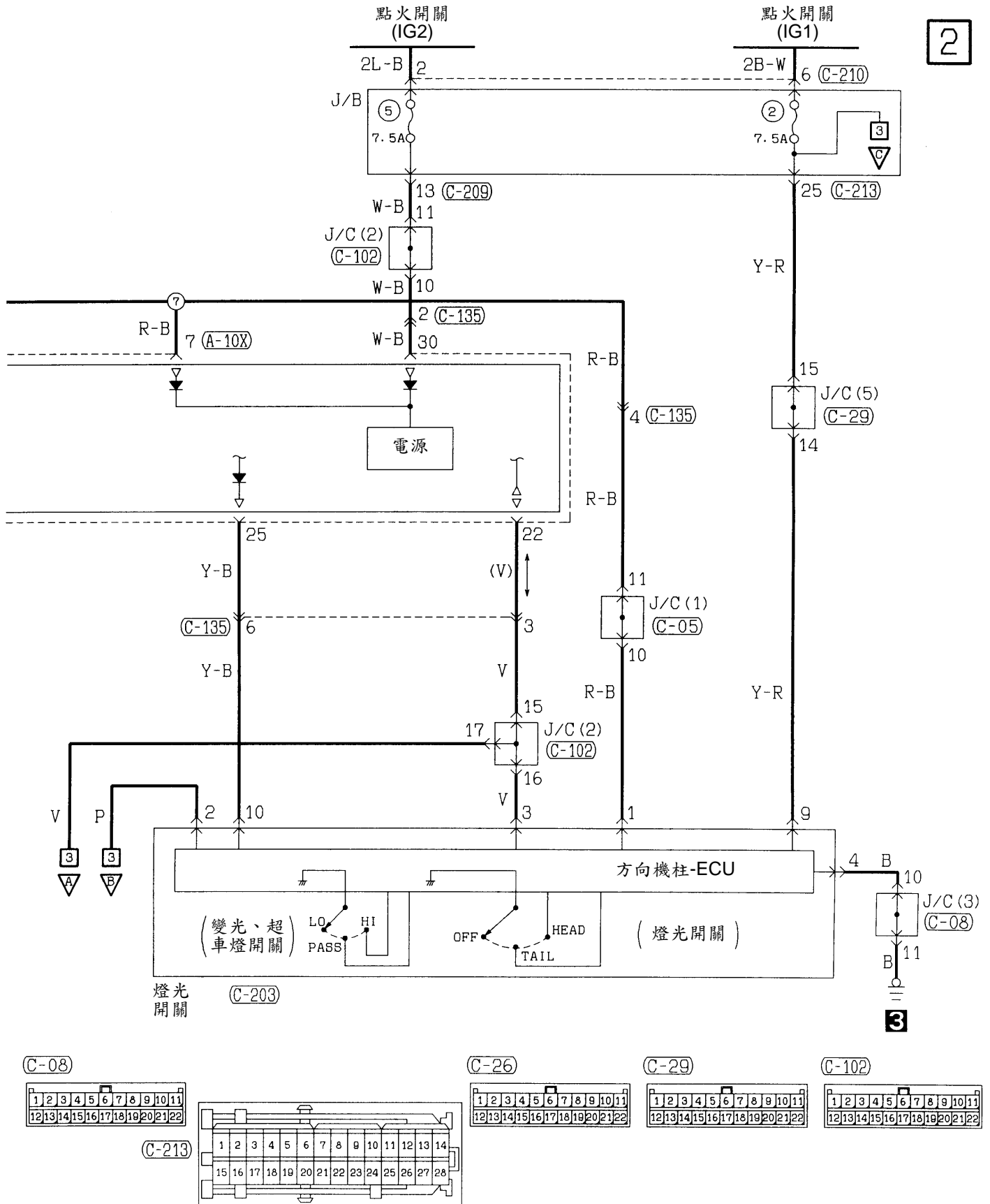

頭燈(續)

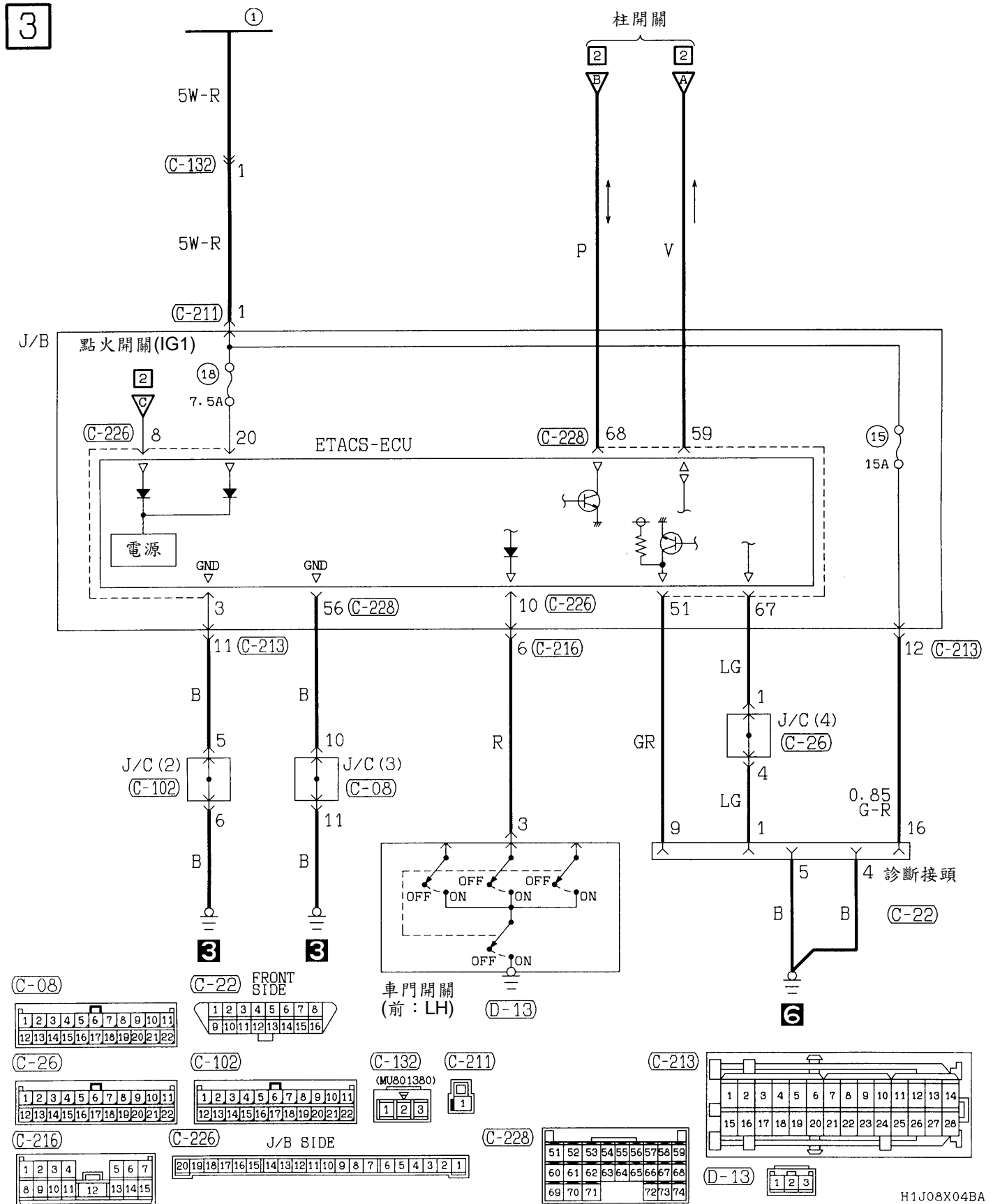

尾燈、位置燈、牌照板燈及燈光監視蜂鳴器

1

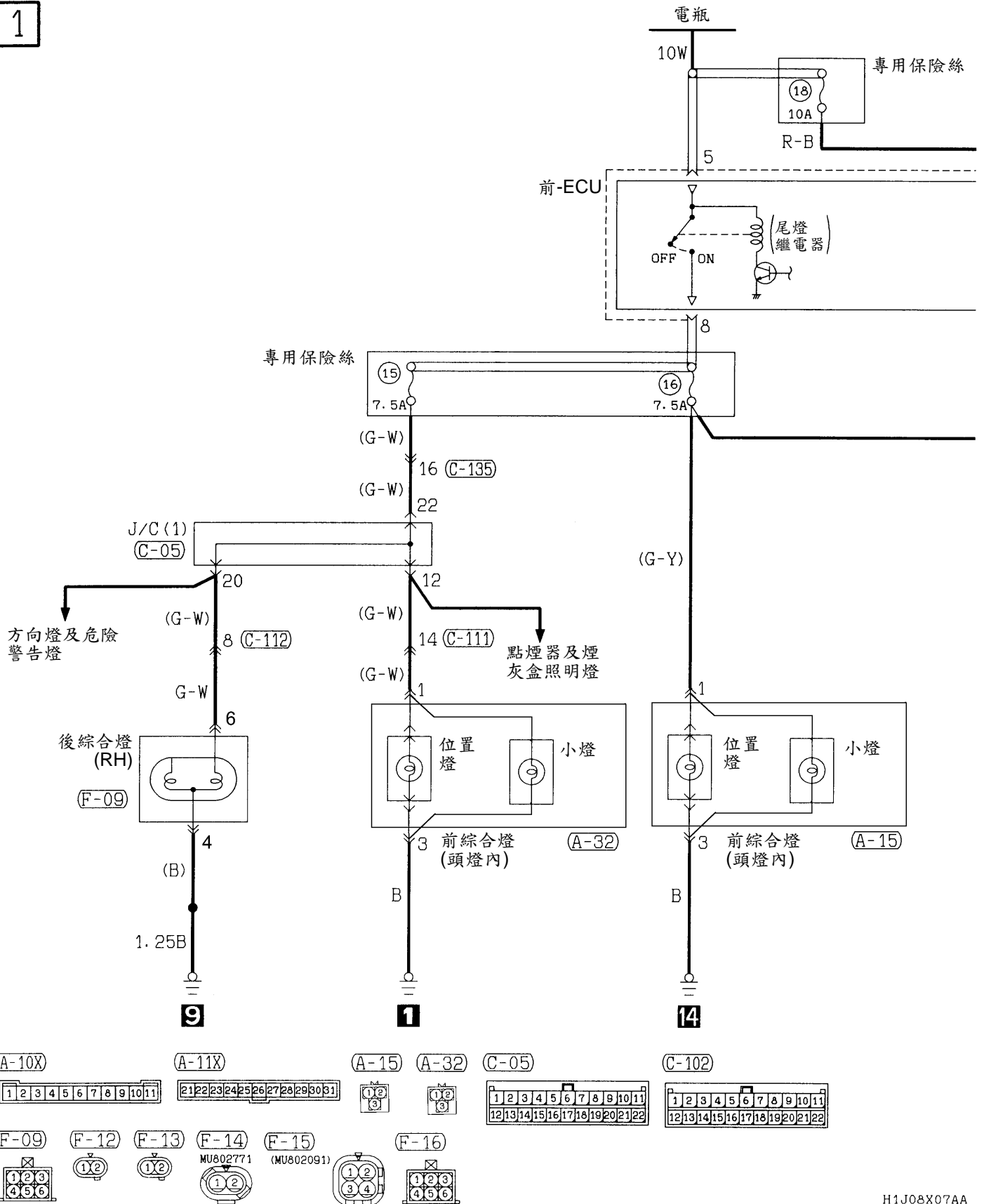

尾燈、位置燈、牌照板燈及燈光監視蜂鳴器(續)

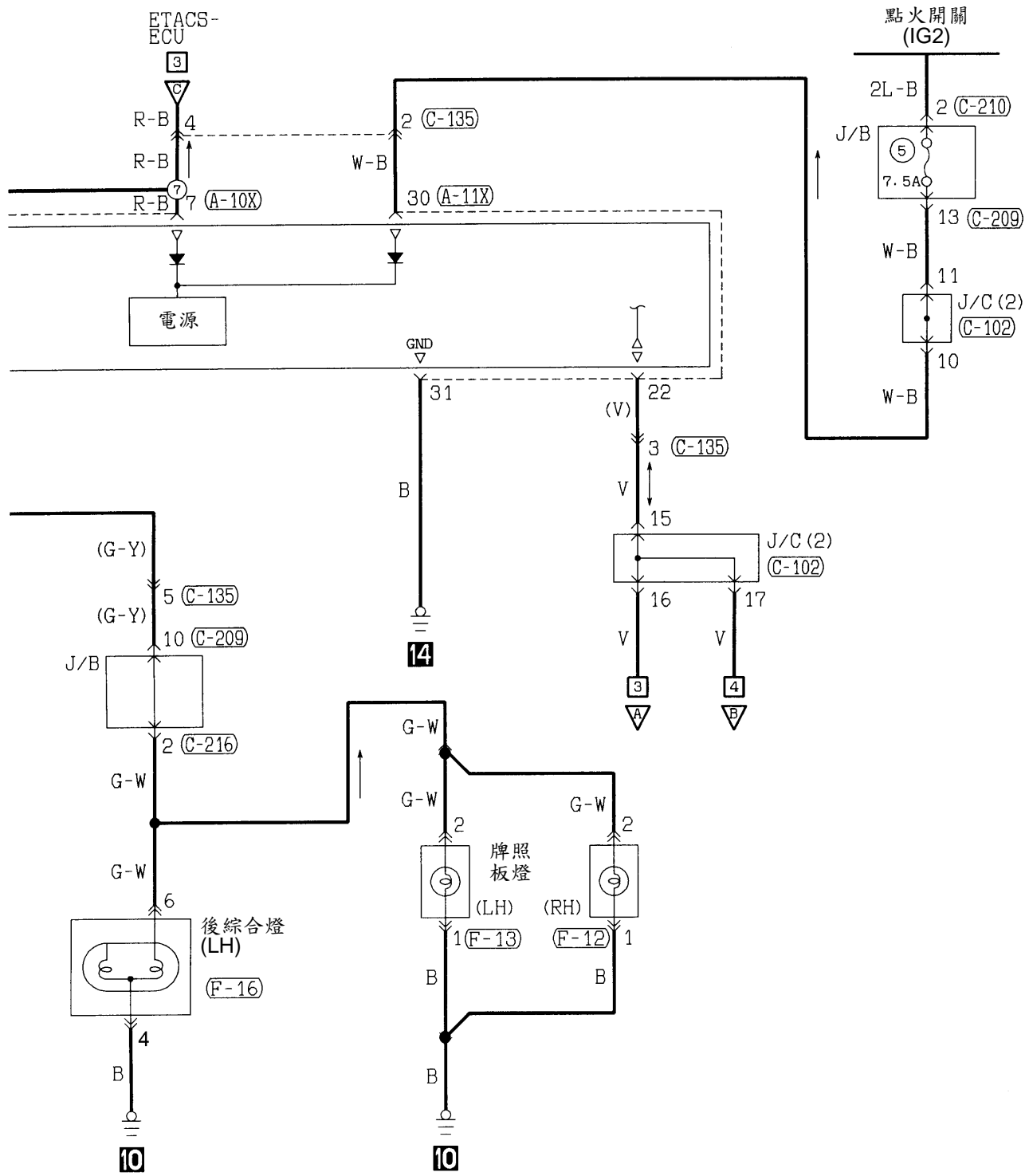

2

(C-111)

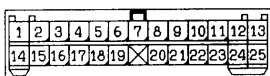

(C-112) MU801855

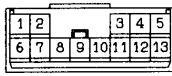

(C-135)

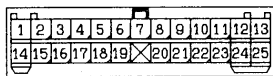

(C-209) MU801857

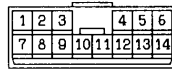

(C-210) MU801331

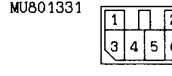

(C-216)

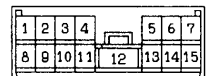

尾燈、位置燈、牌照板燈及燈光監視蜂鳴器(續)

3

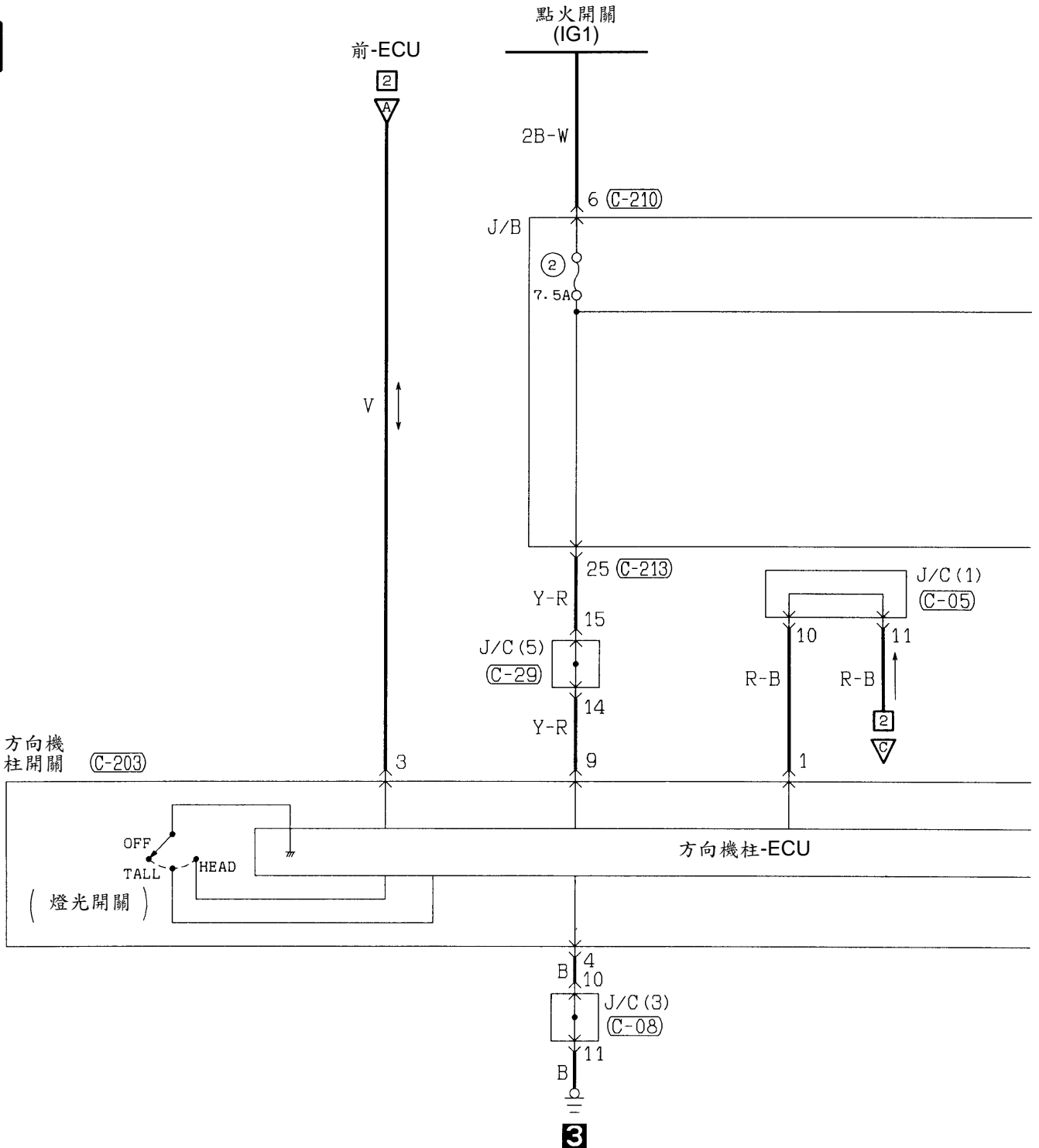

(C-05)

1	2	3	4	5	6	7	8	9	10	11
12	13	14	15	16	17	18	19	20	21	22

(C-08)

1	2	3	4	5	6	7	8	9	10	11
12	13	14	15	16	17	18	19	20	21	22

(C-22) FRONT SIDE

1	2	3	4	5	6	7	8
9	10	11	12	13	14	15	16

(C-26)

1	2	3	4	5	6	7	8	9	10	11
12	13	14	15	16	17	18	19	20	21	22

(C-29)

1	2	3	4	5	6	7	8	9	10	11
12	13	14	15	16	17	18	19	20	21	22

(C-216)

1	2	3	4	5	6	7	
8	9	10	11	12	13	14	15

(C-226)

J/B SIDE

20	19	18	17	16	15	14	13	12	11	10	9	8	7	6	5	4	3	2	1
----	----	----	----	----	----	----	----	----	----	----	---	---	---	---	---	---	---	---	---

(C-228)

51	52	53	54	55	56	57	58	59
60	61	62	63	64	65	66	67	68
69	70	71	72	73	74			

(D-13)

1	2	3
---	---	---

尾燈、位置燈、牌照板燈及燈光監視蜂鳴器(續)

4

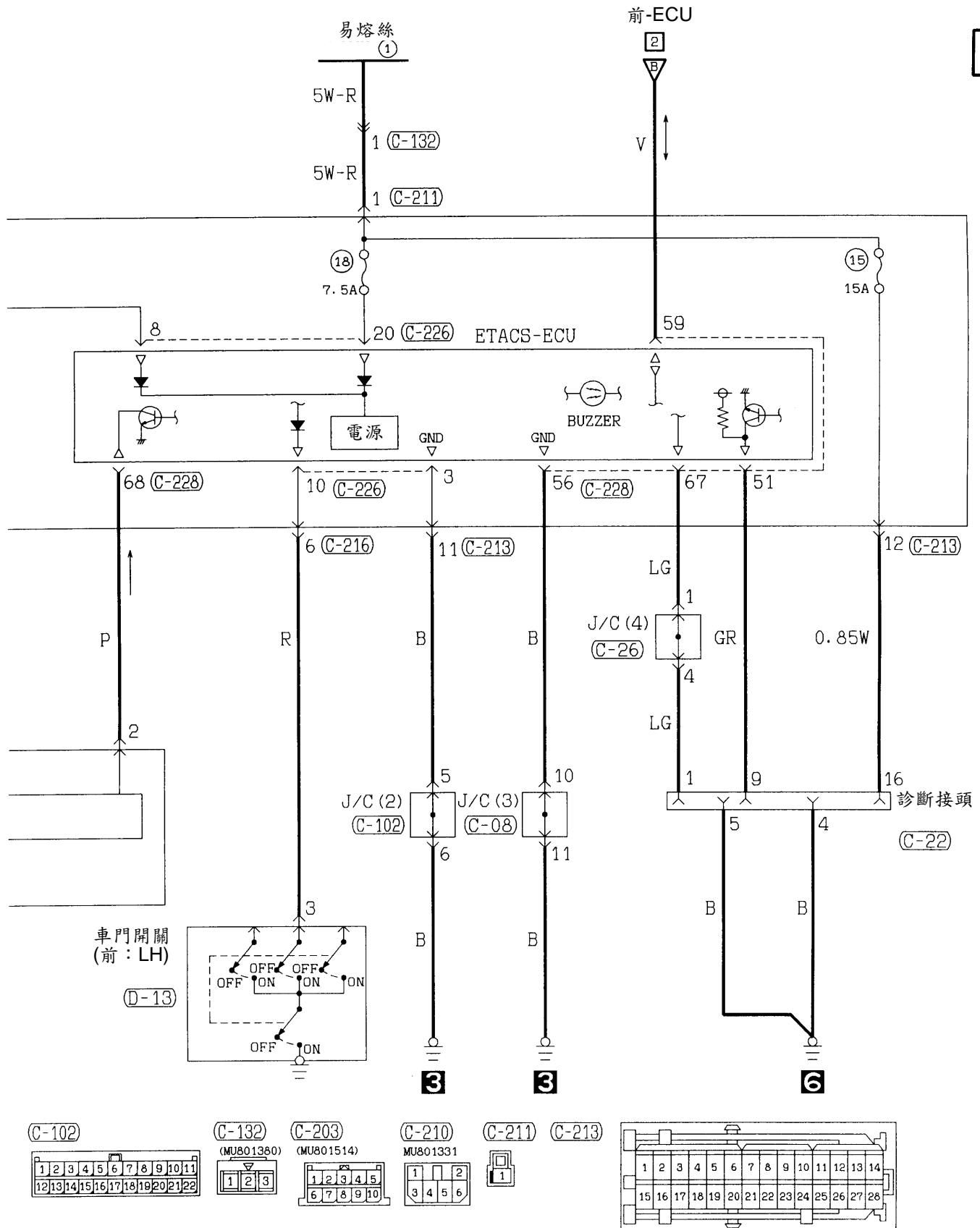

室內燈、行李箱燈及點火開關照明燈

1

註
*1: 未配備天窗車輛
*2: 配備天窗車輛

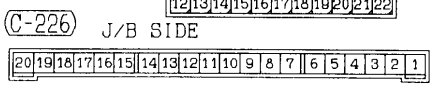
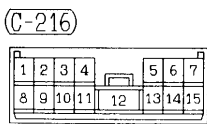
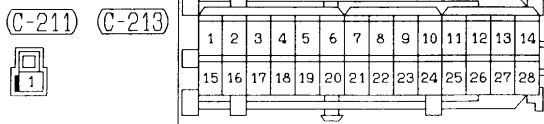
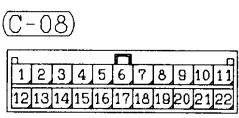
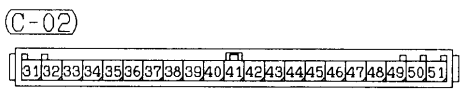
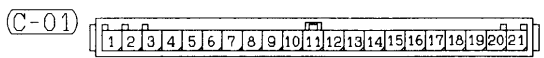
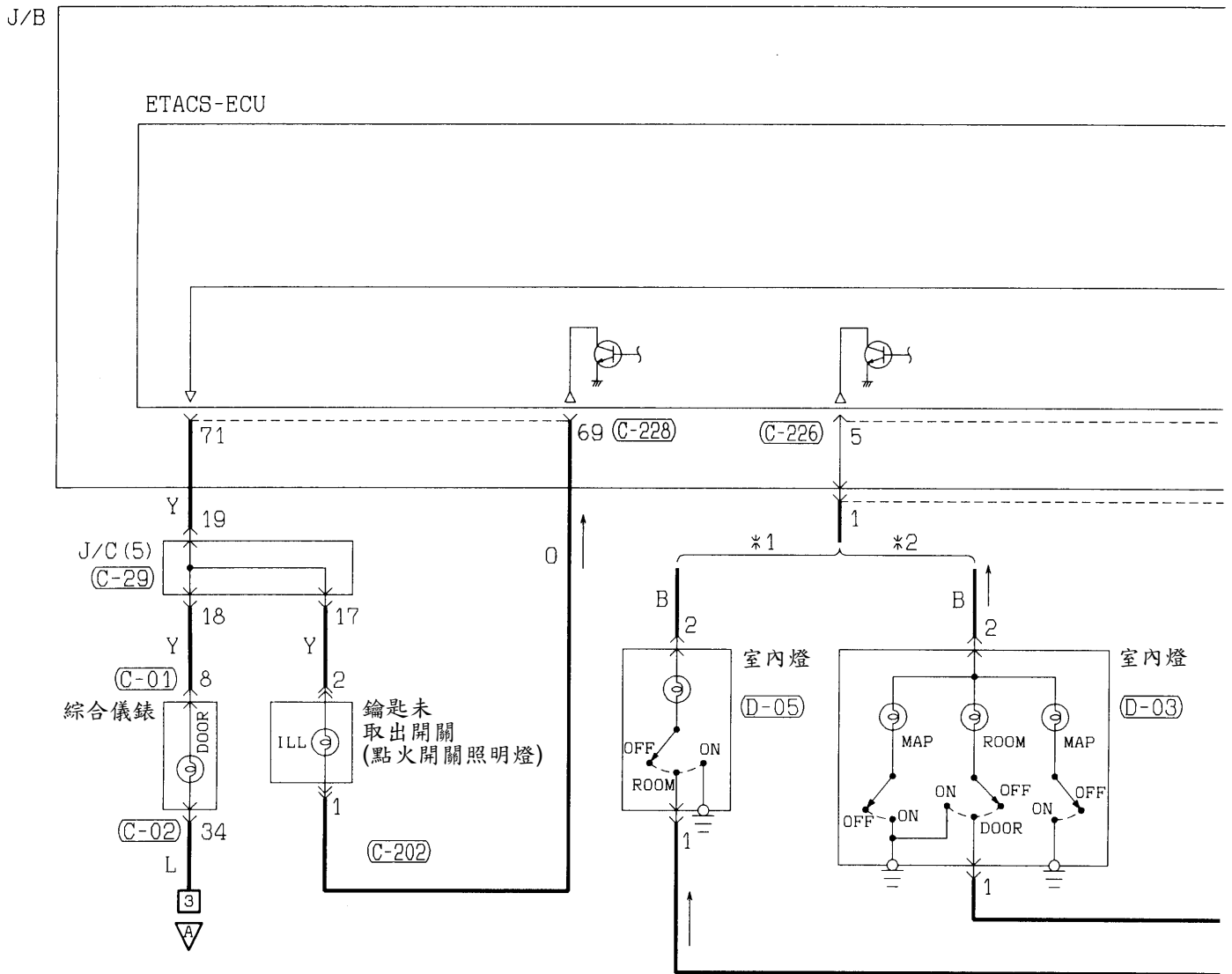

室內燈、行李箱燈及點火開關點用燈(續)

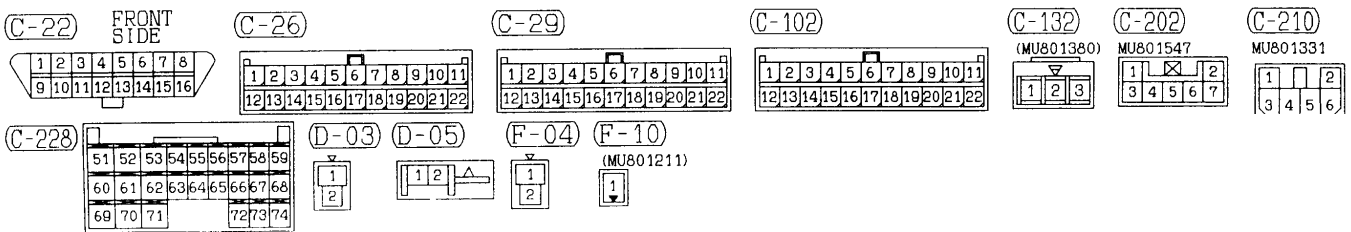
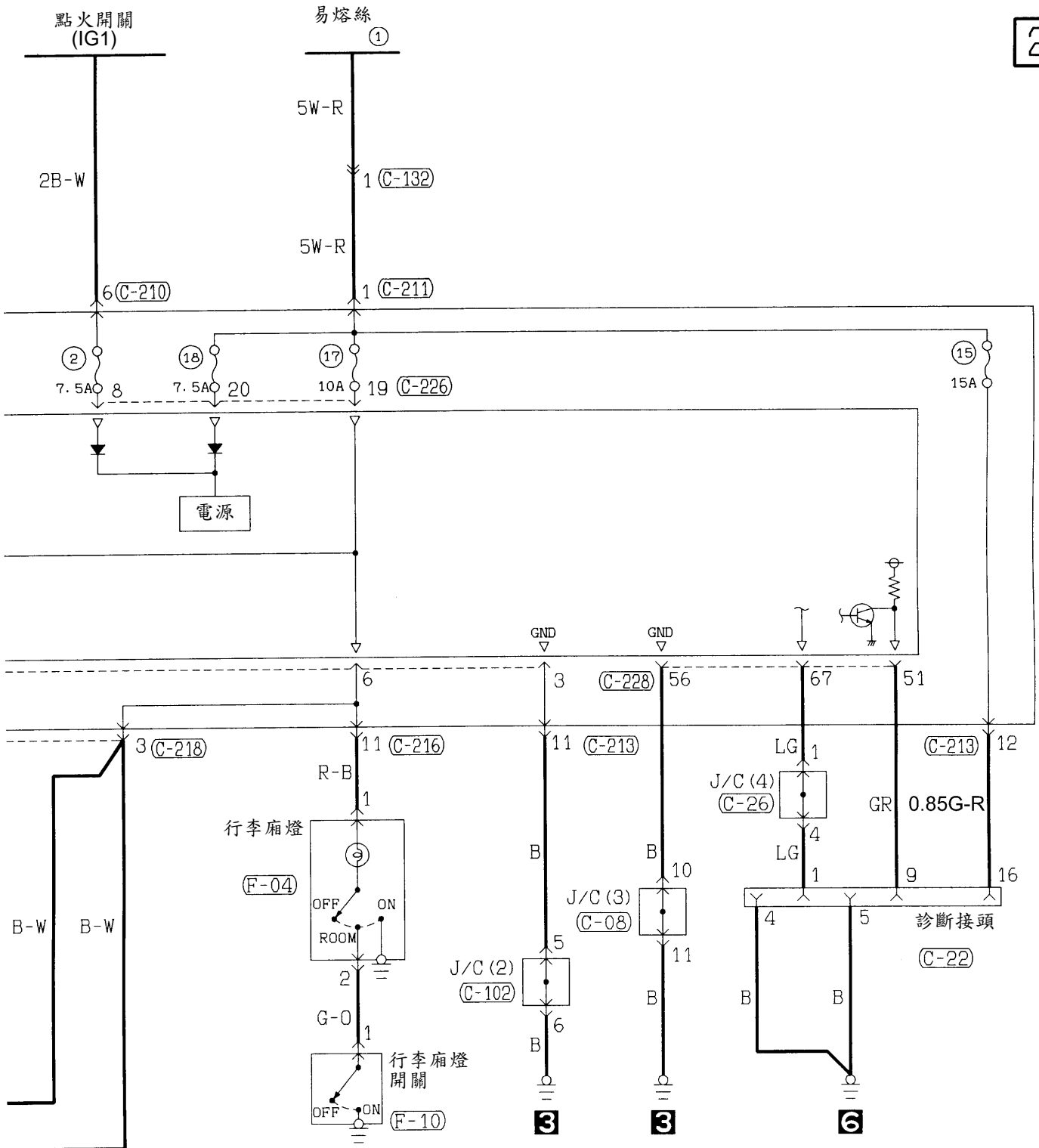

室內燈、行李箱燈及點火開關點燈(續)

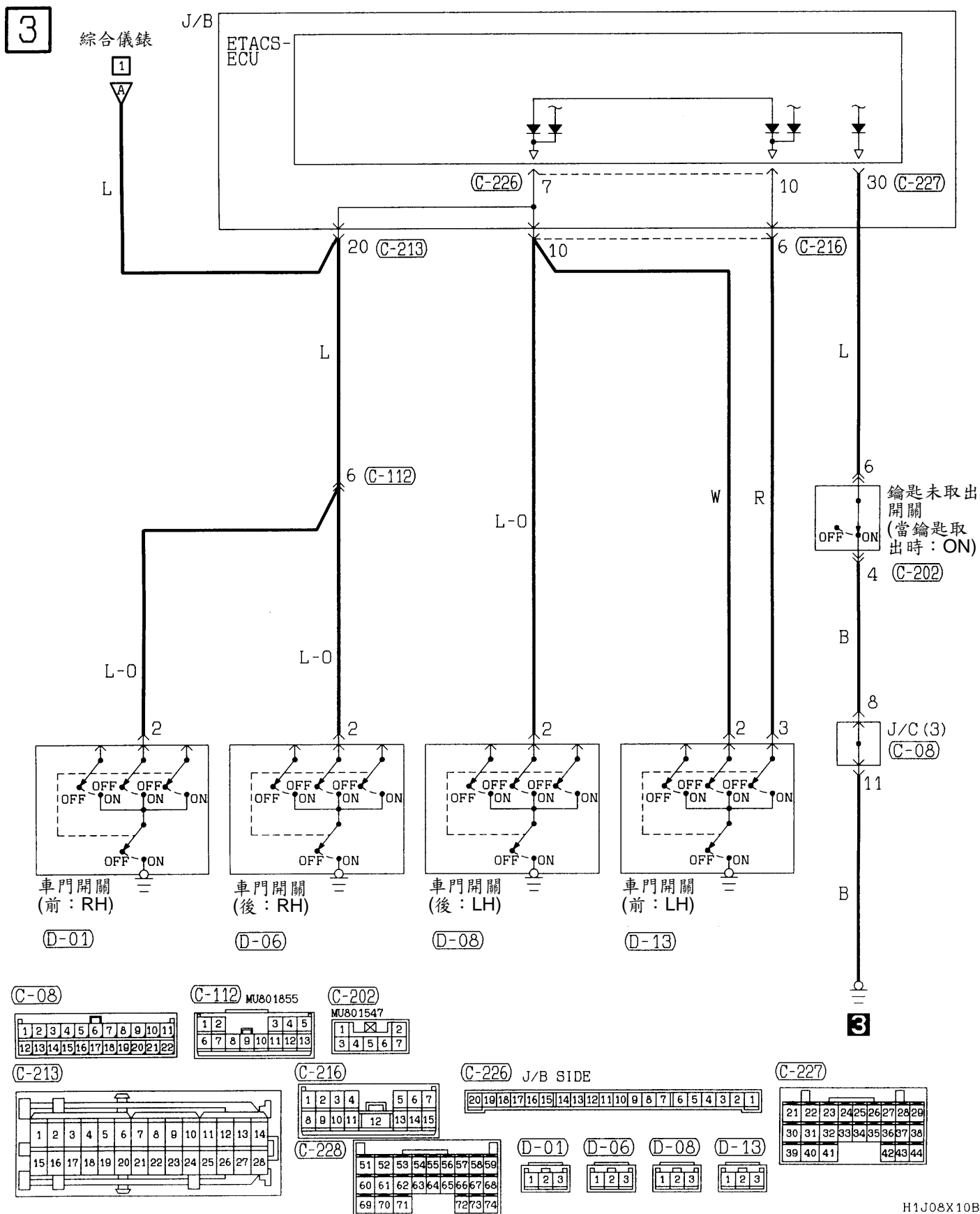

H1J08X10B/

前霧燈

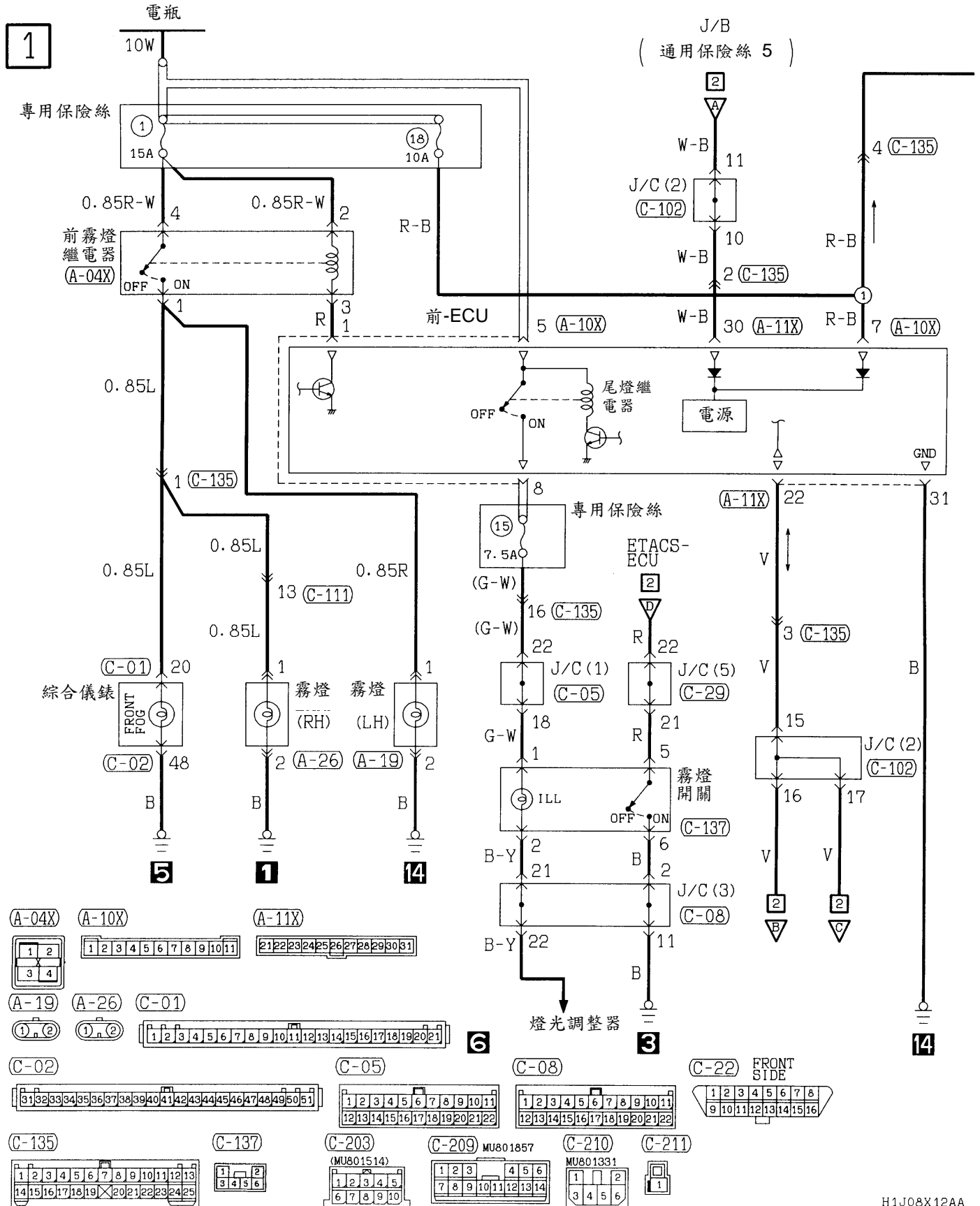

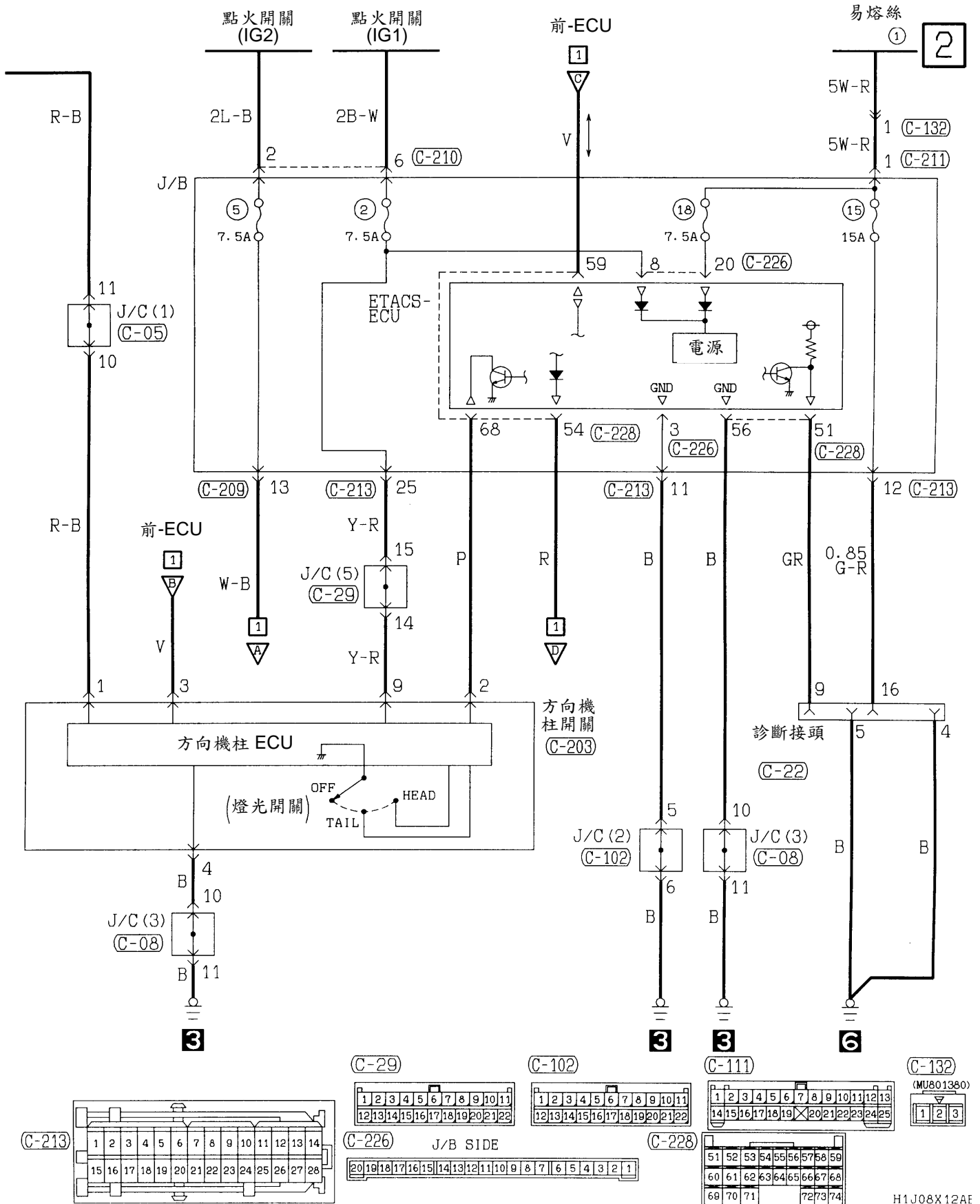

方向燈及危險警告燈

1

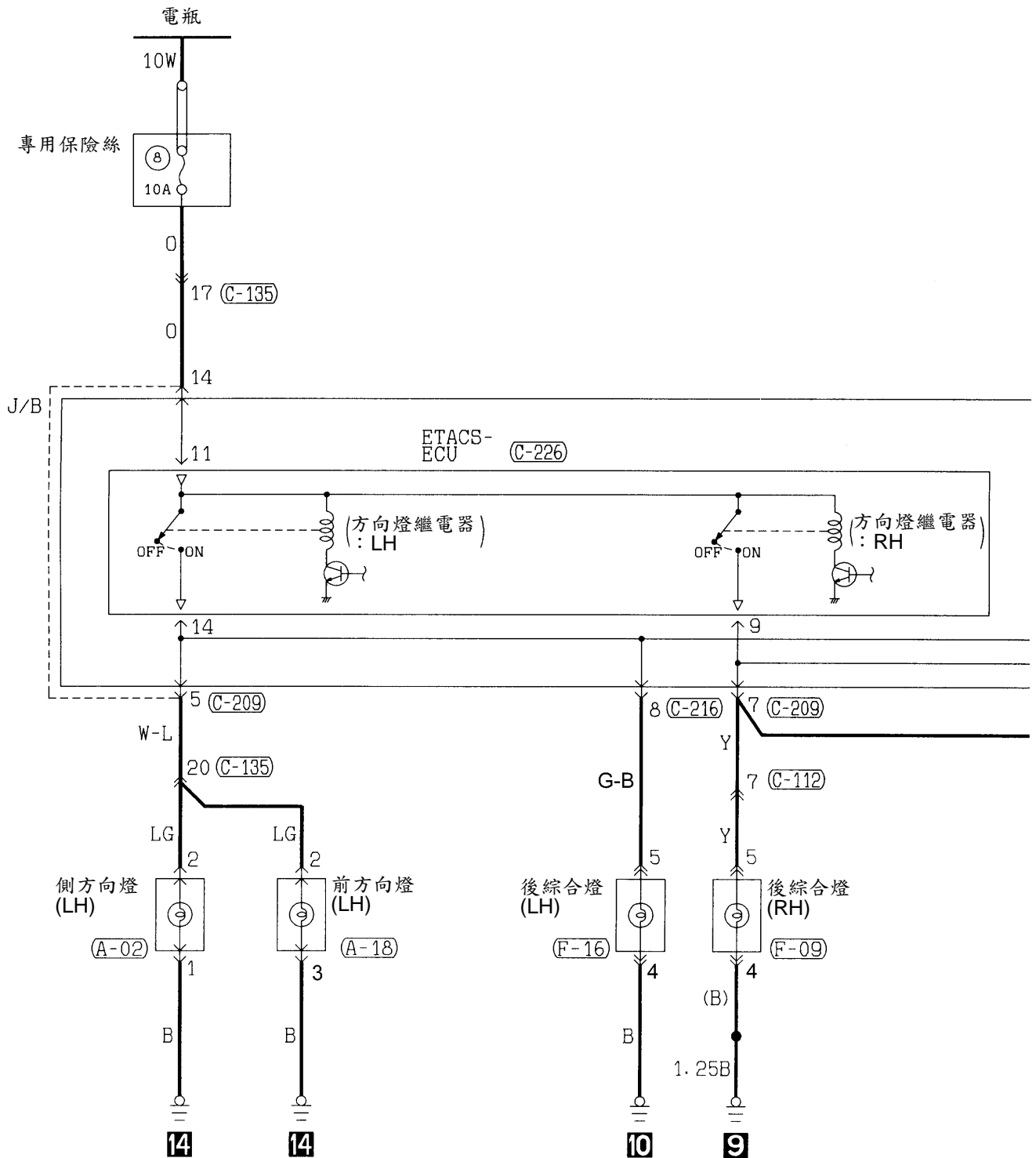

(A-01) (A-02) (A-18) (A-27) (C-01)

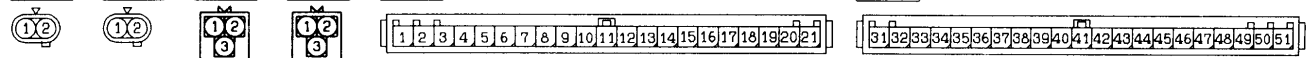

(C-216)

(C-226) J/B SIDE

(F-09) (F-16)

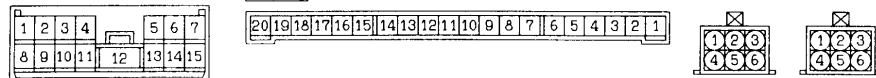

方戶燈及危險警告燈(續)

2

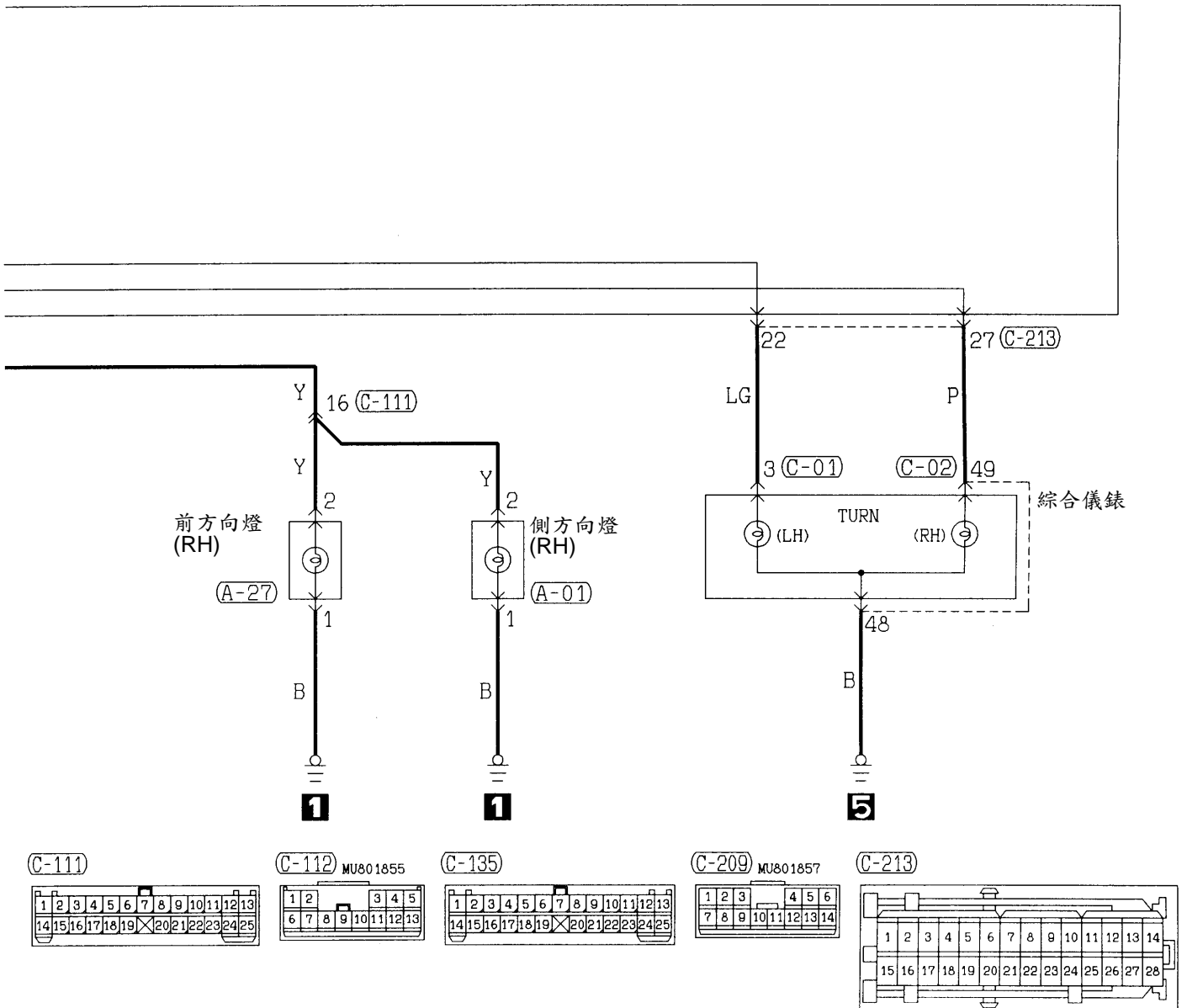

方戶燈及危險警告燈(續)

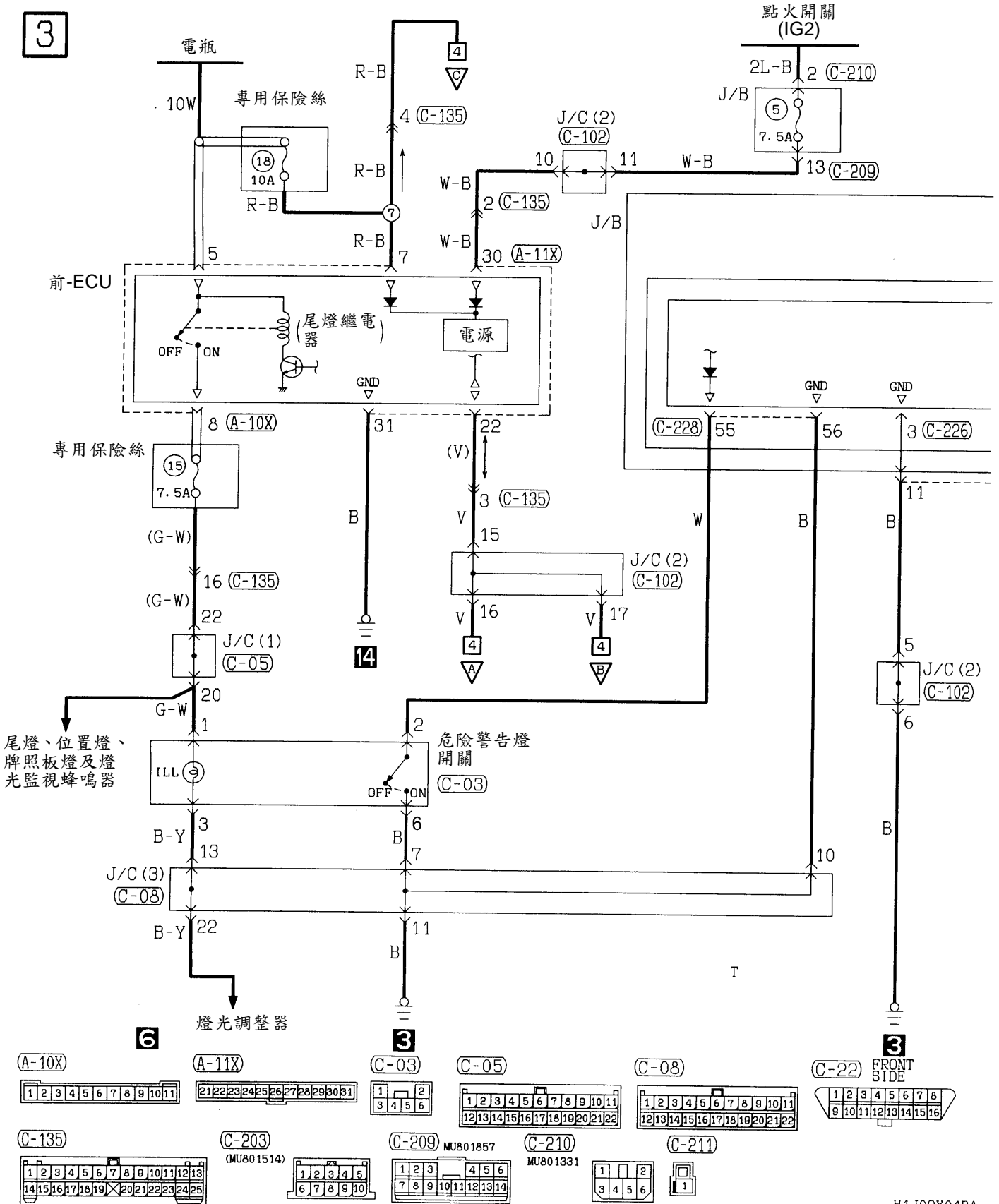

H1J09X04BA

方向燈及危險警告燈(續)

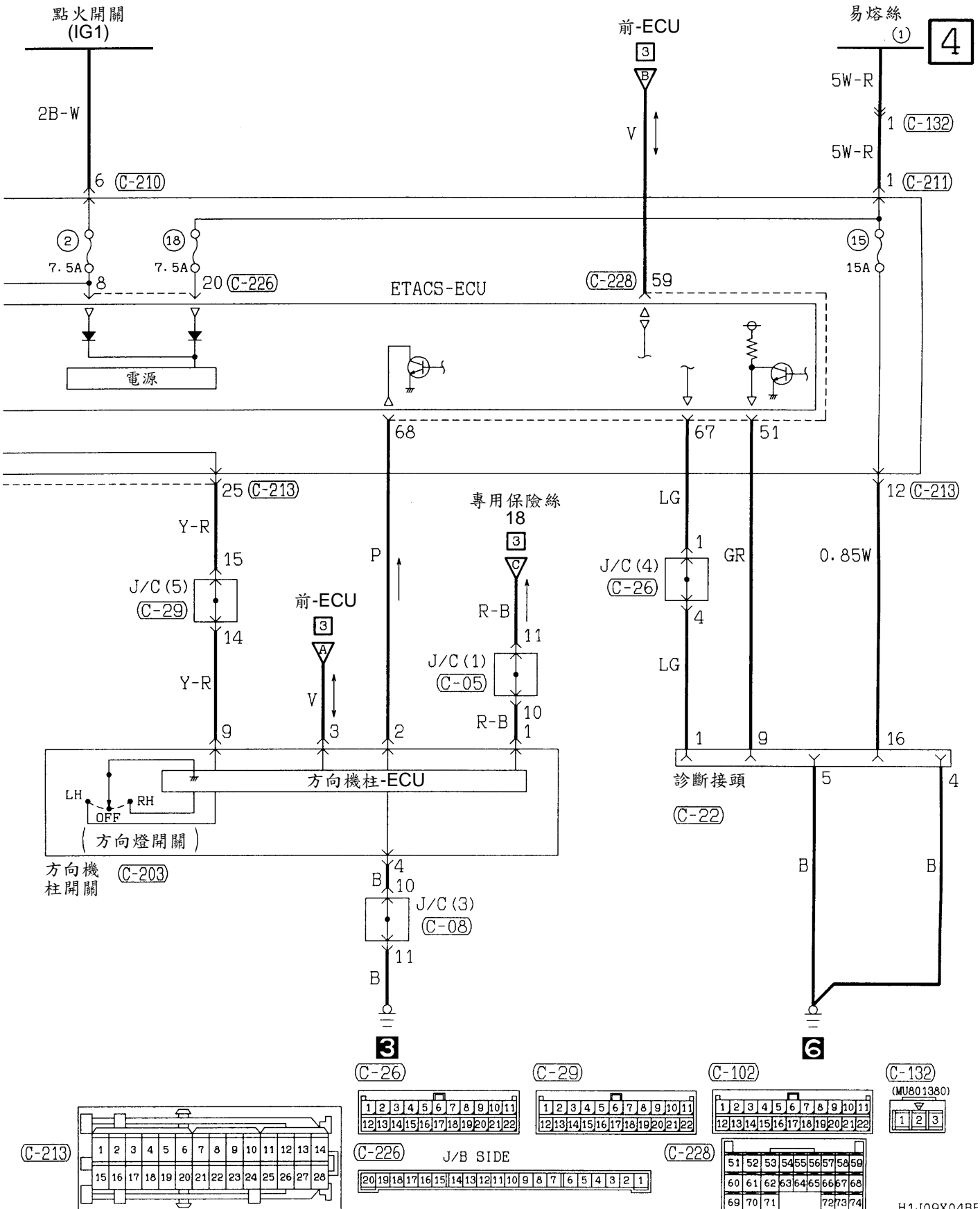

倒車燈

1

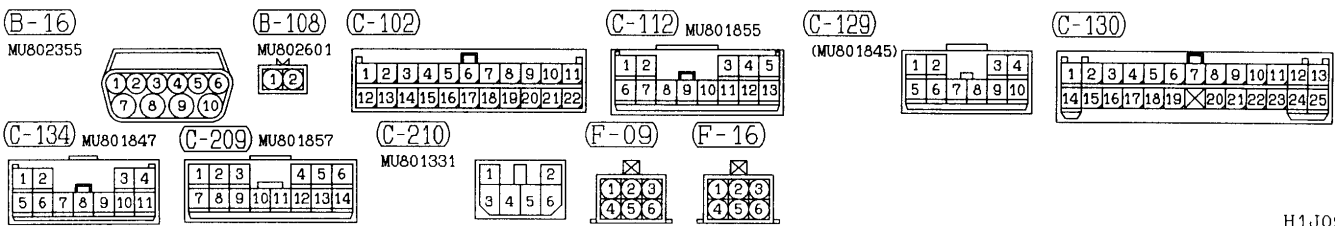
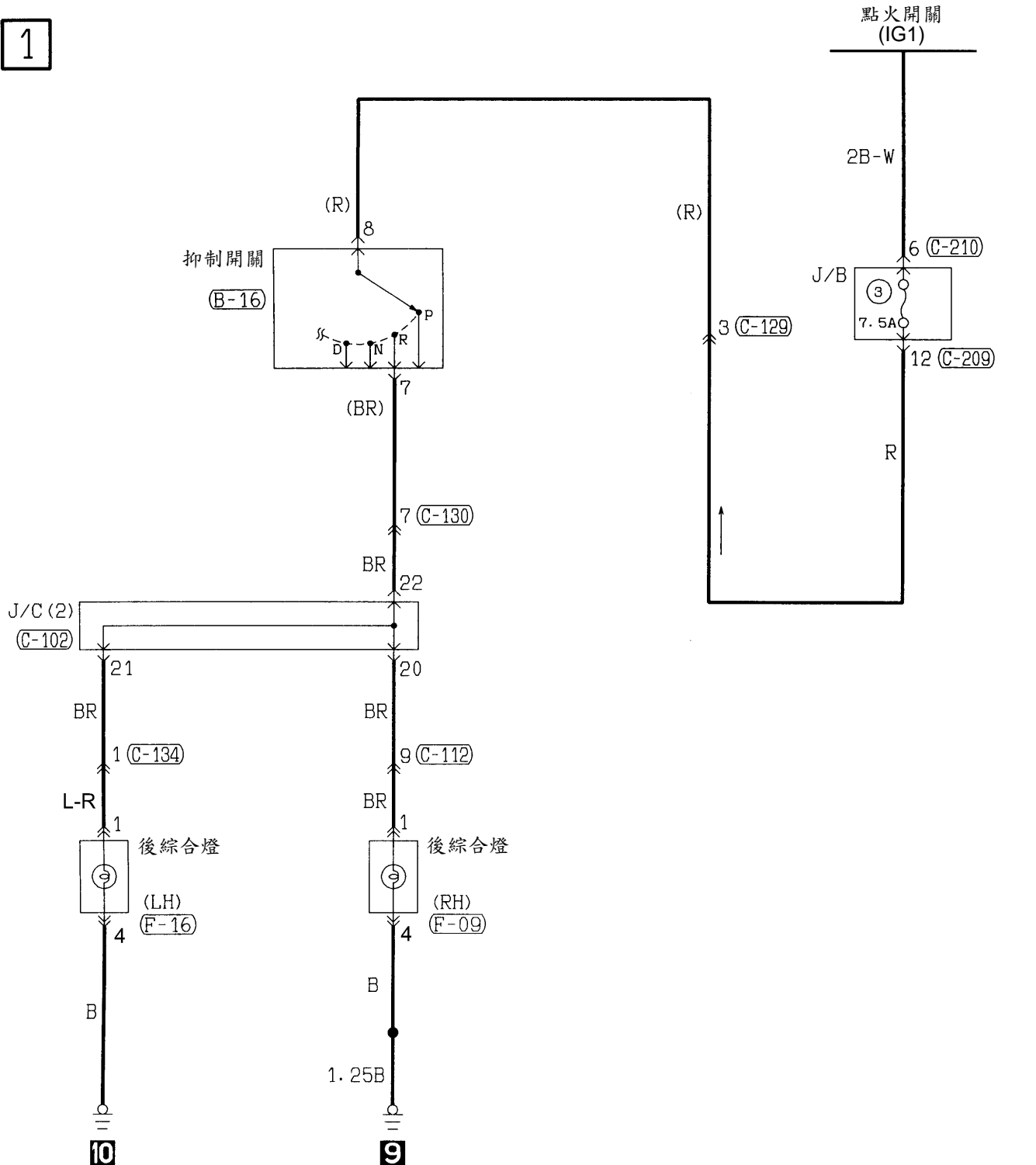

剎車燈

1

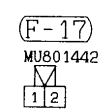
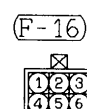
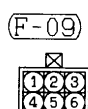
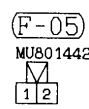
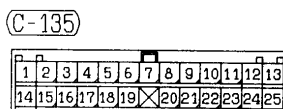
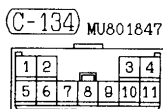
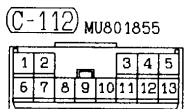
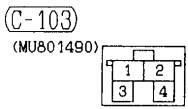
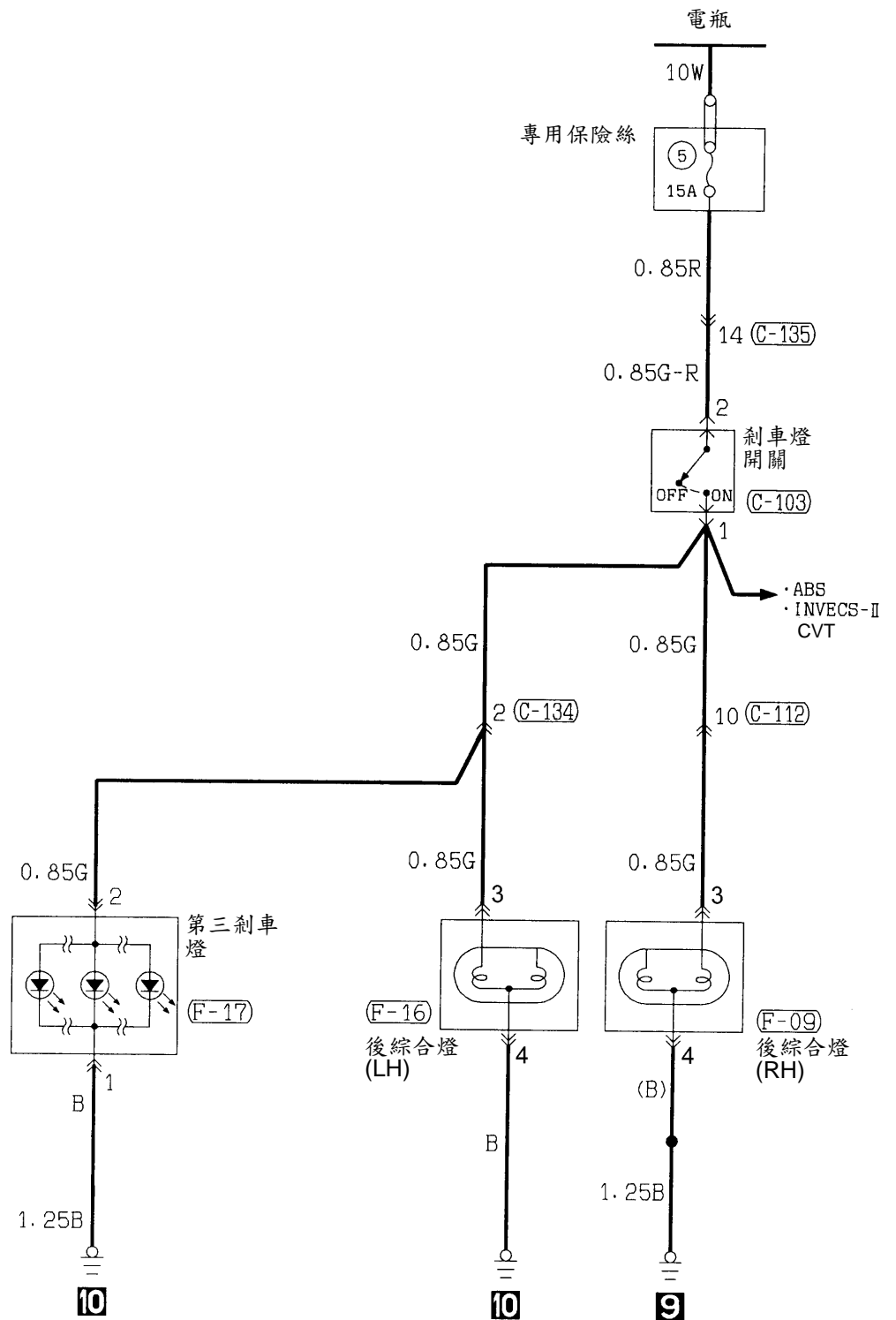

喇叭

1

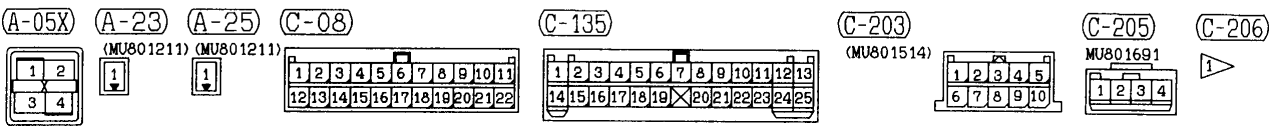
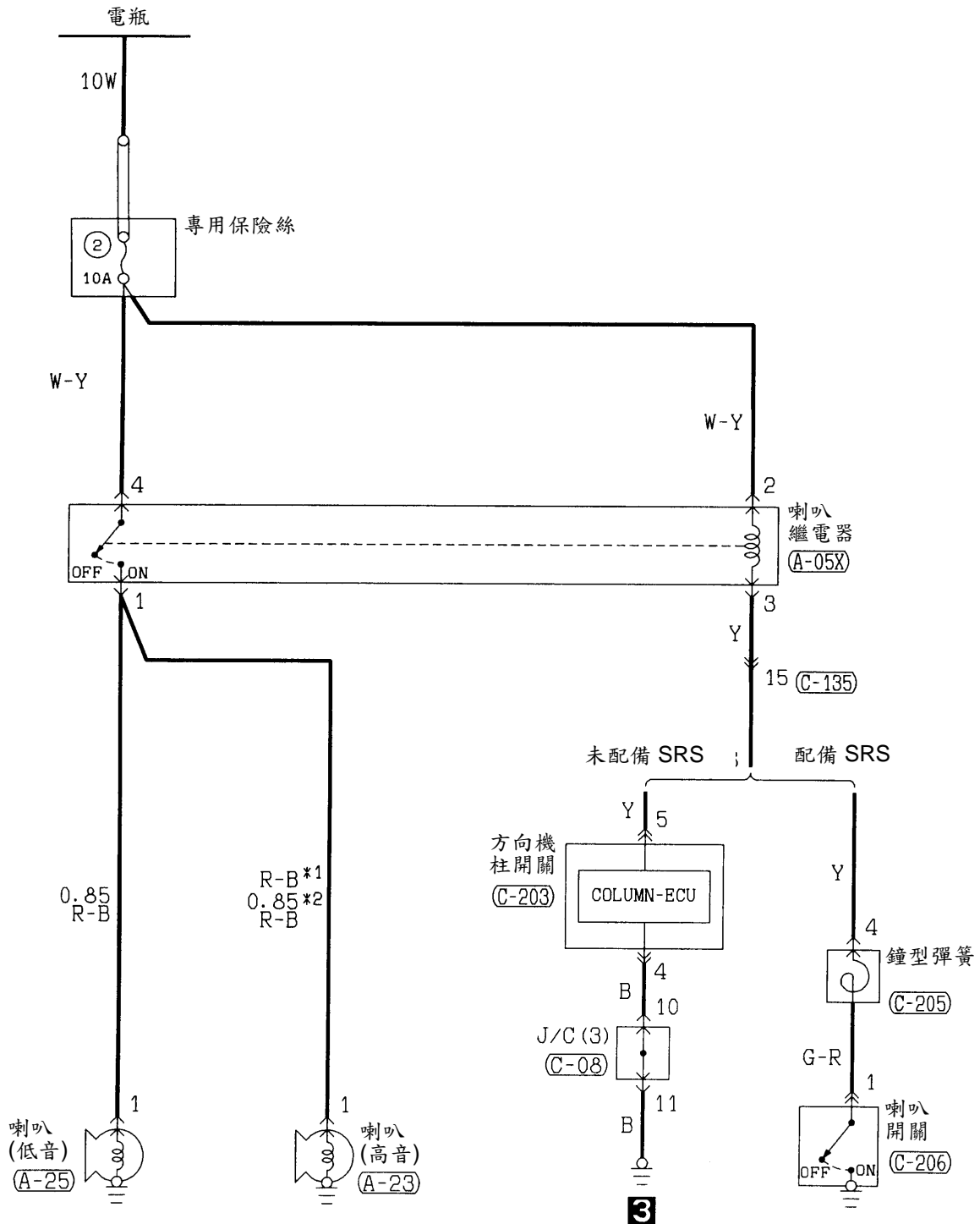

儀表

1

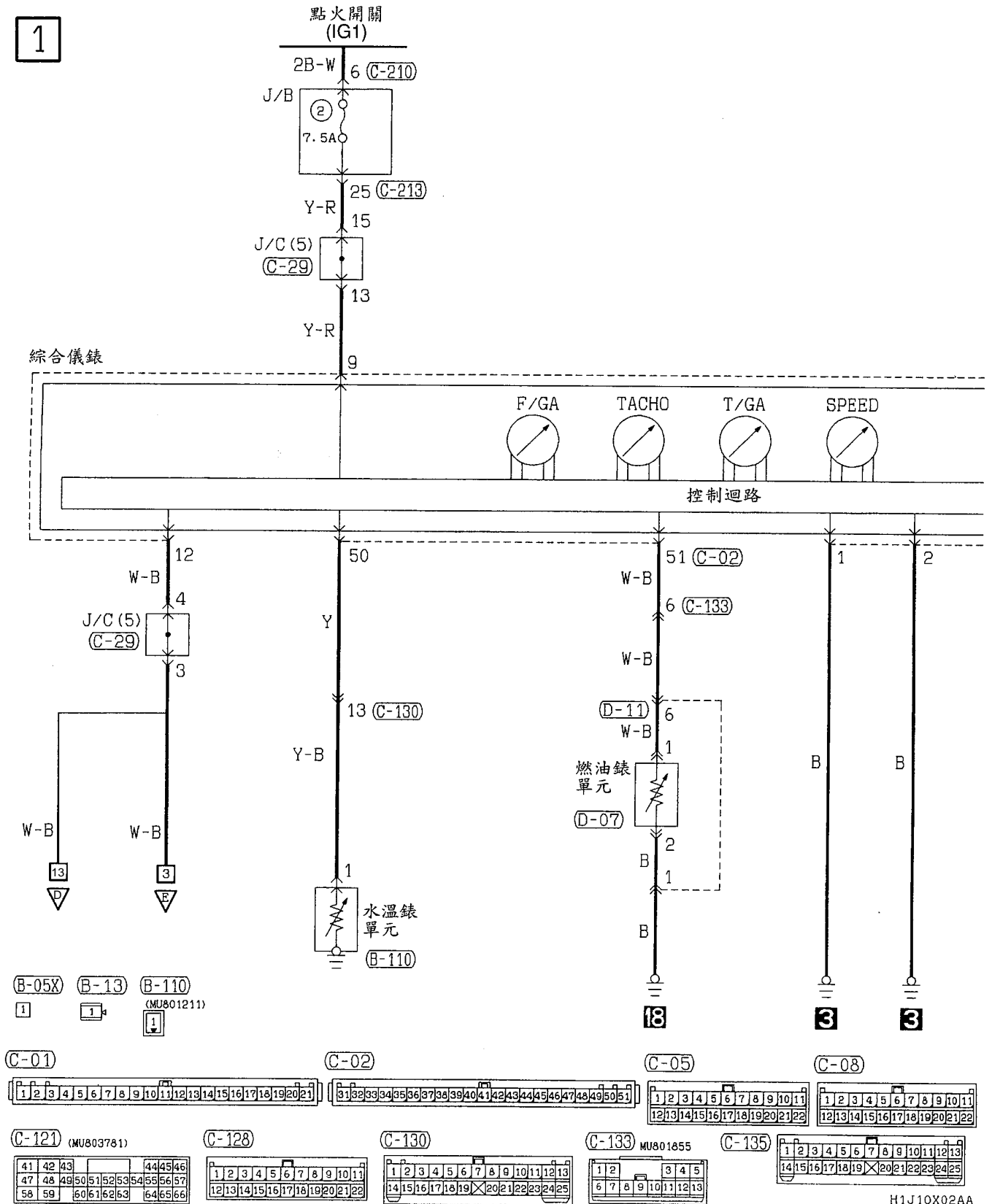

H1J10X02AA

儀表(續)

2

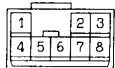
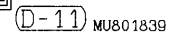
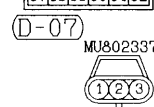
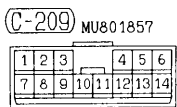
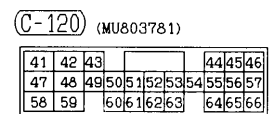
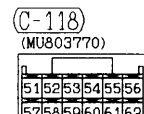
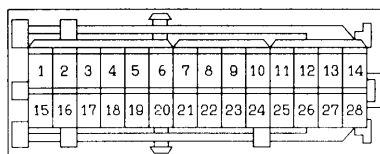
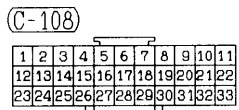
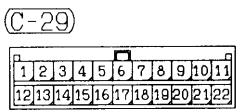
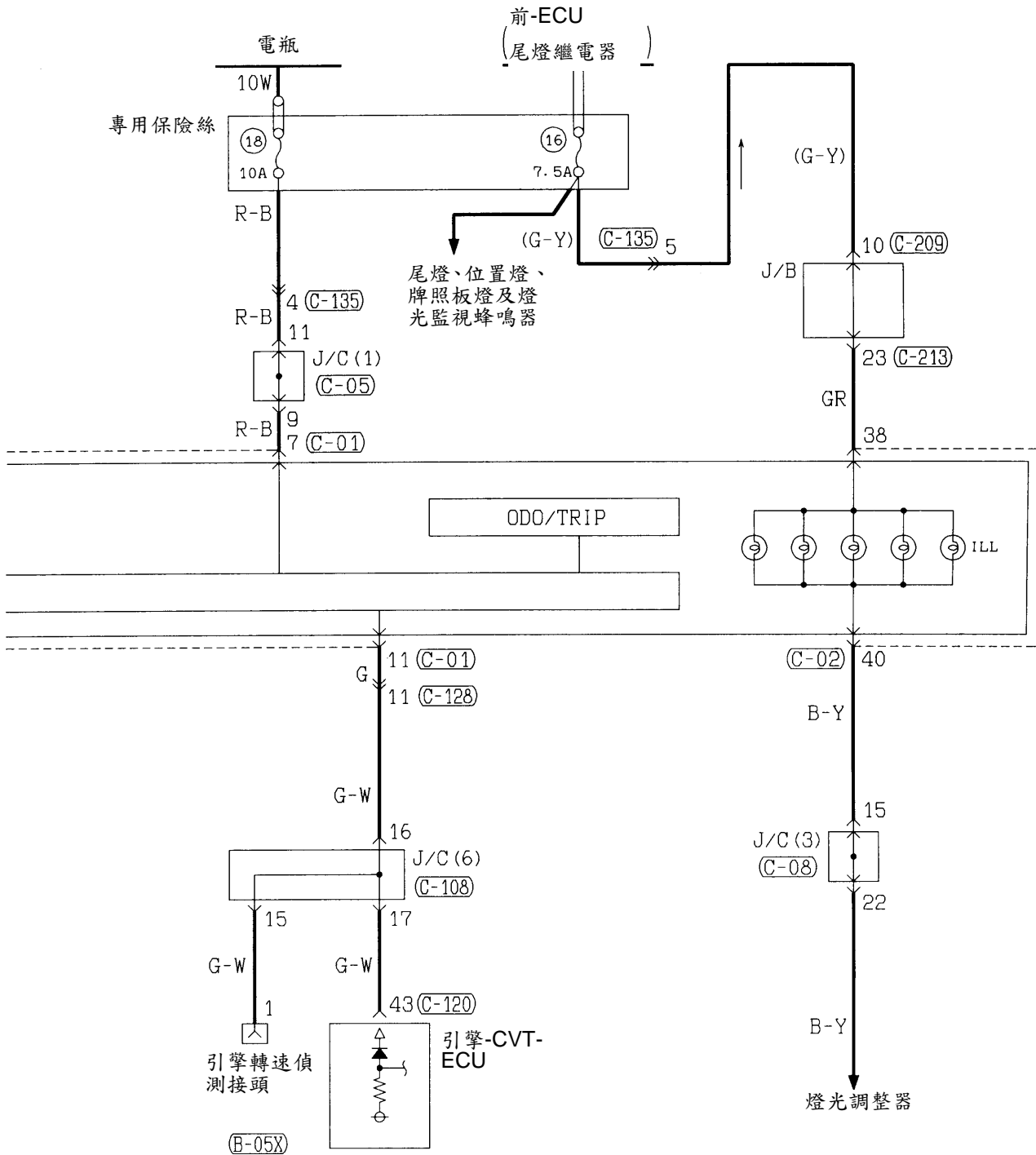

H1J10X02A

儀表(續)

3

引擎-CVT-ECU

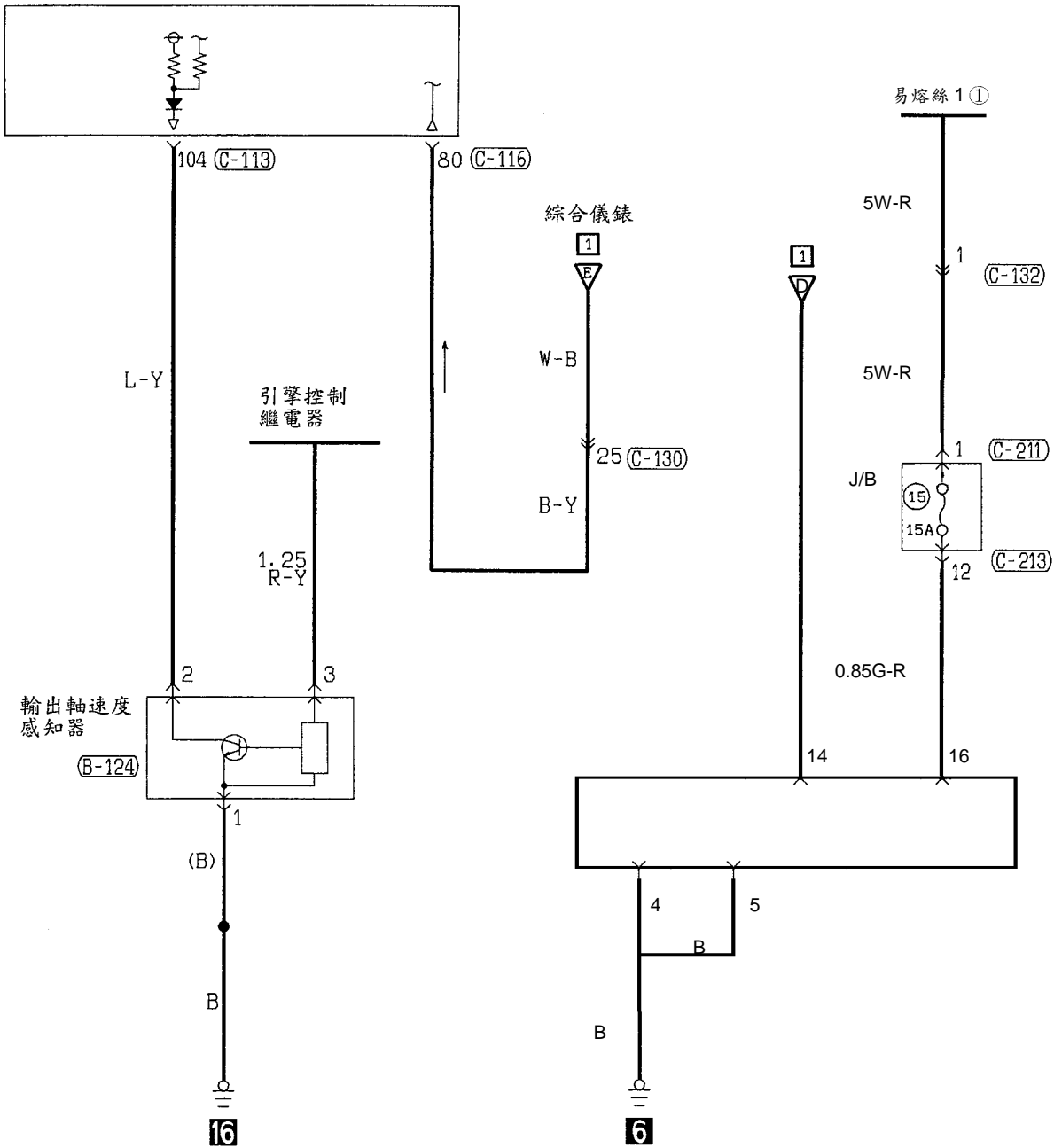

(C-130)

1	2	3	4	5	6	7	8	9	10	11	12	13
14	15	16	17	18	19	X	20	21	22	23	24	25

燃油存量不足警示燈

1

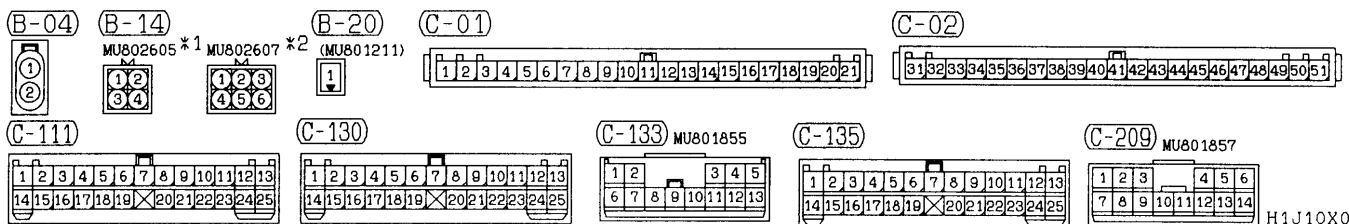
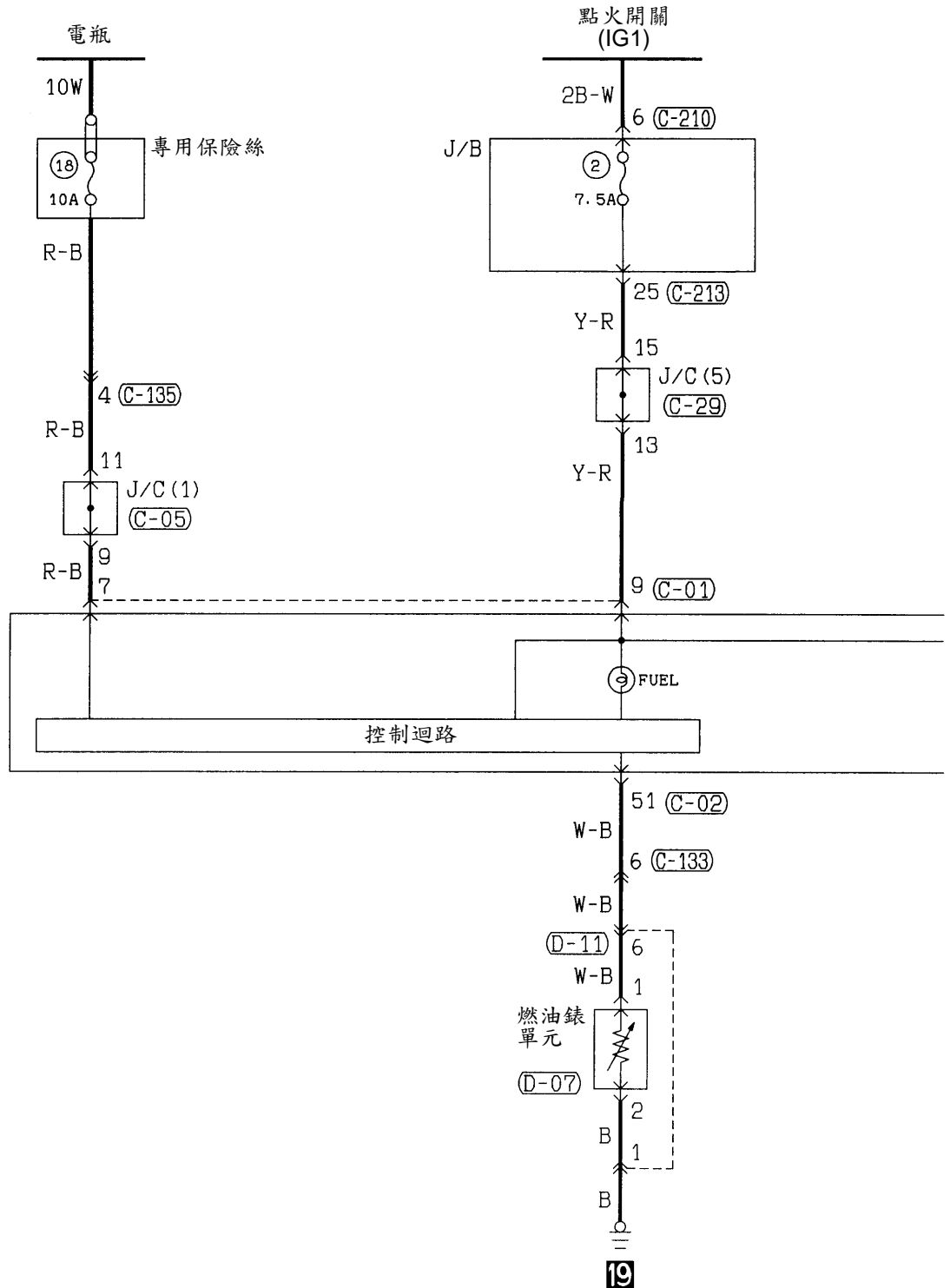

機油壓力警告燈、剎車警告燈

2

綜合儀錶

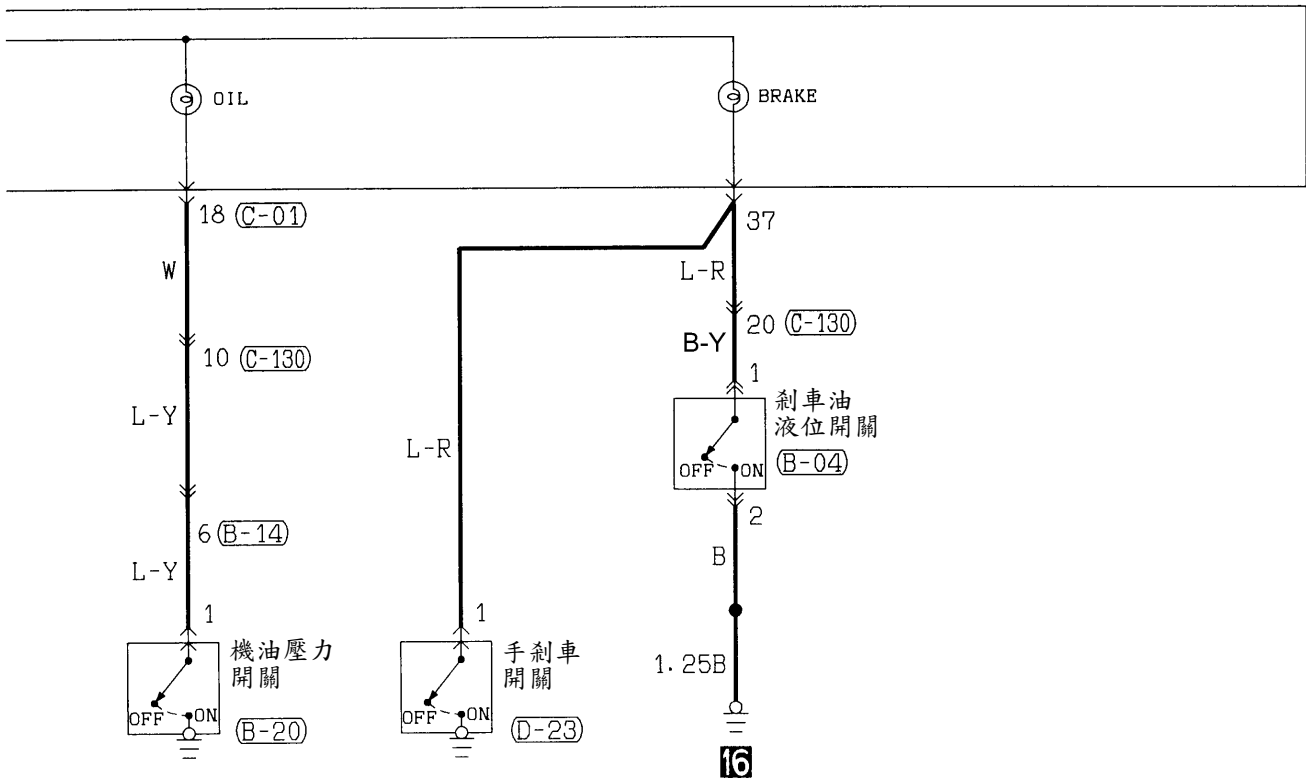

(C-05)

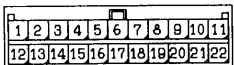

(C-210)
MU801331



(C-213)

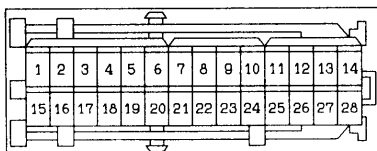

(C-08)

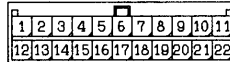

(D-07)
MU802337



(D-11)
MU801839



(C-29)

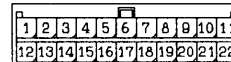

(D-14)
MU801441



(D-23)
(MU801211)



(C-102)



H1J10X05AB

電動窗

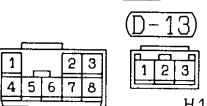
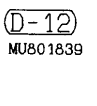
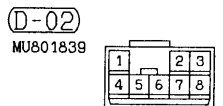
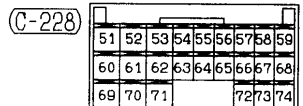
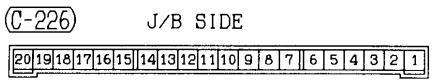
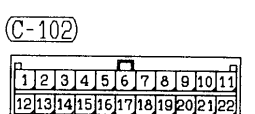
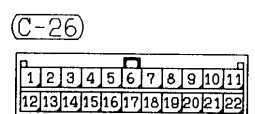
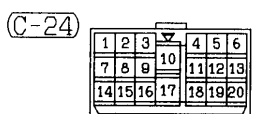
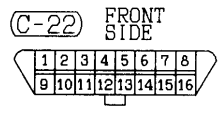
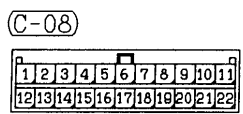
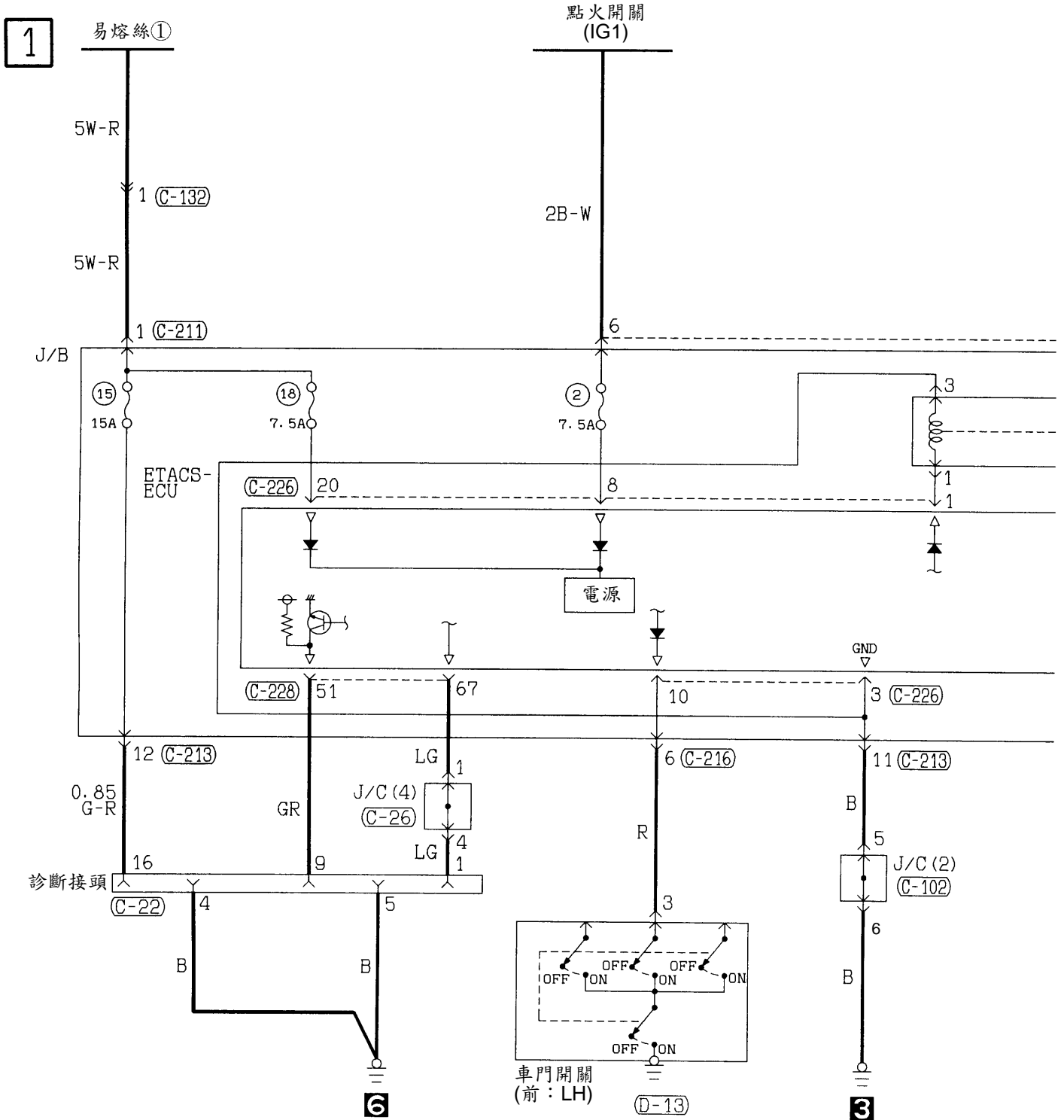

H1J11X02AA

電動窗(續)

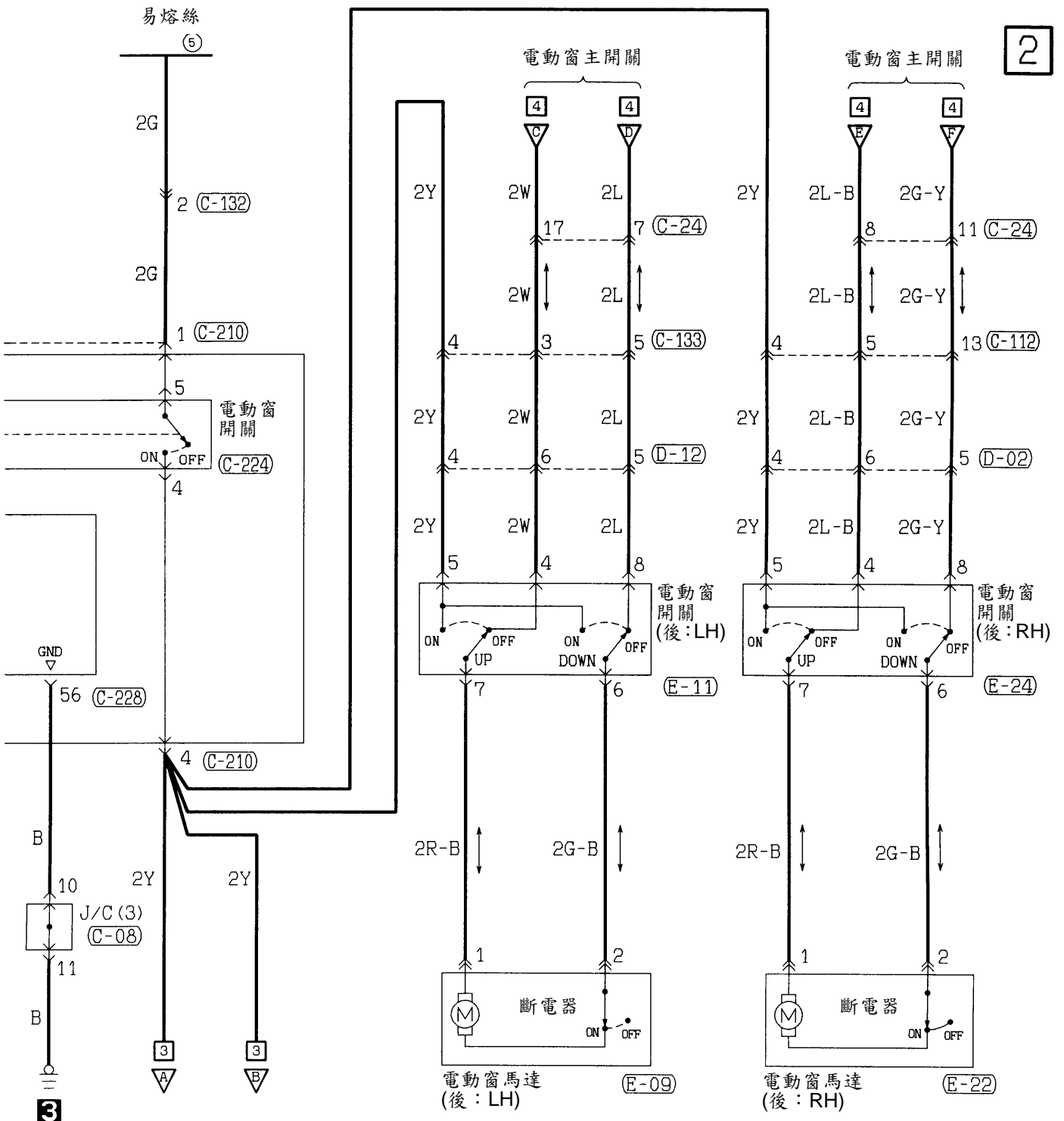

2

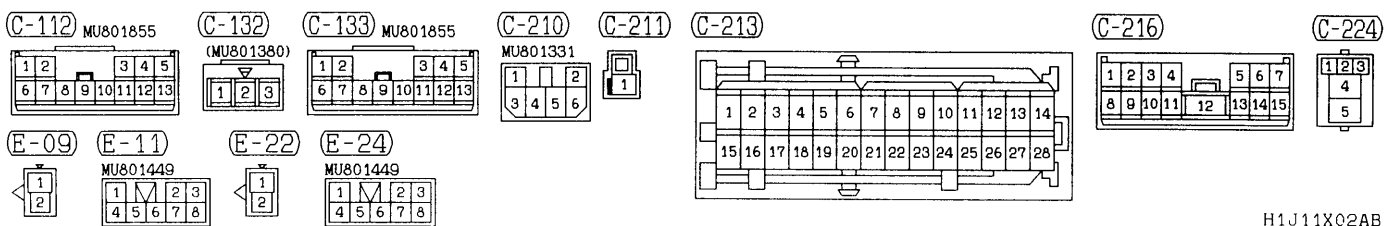

H1J11X02AB

電動窗(續)

3

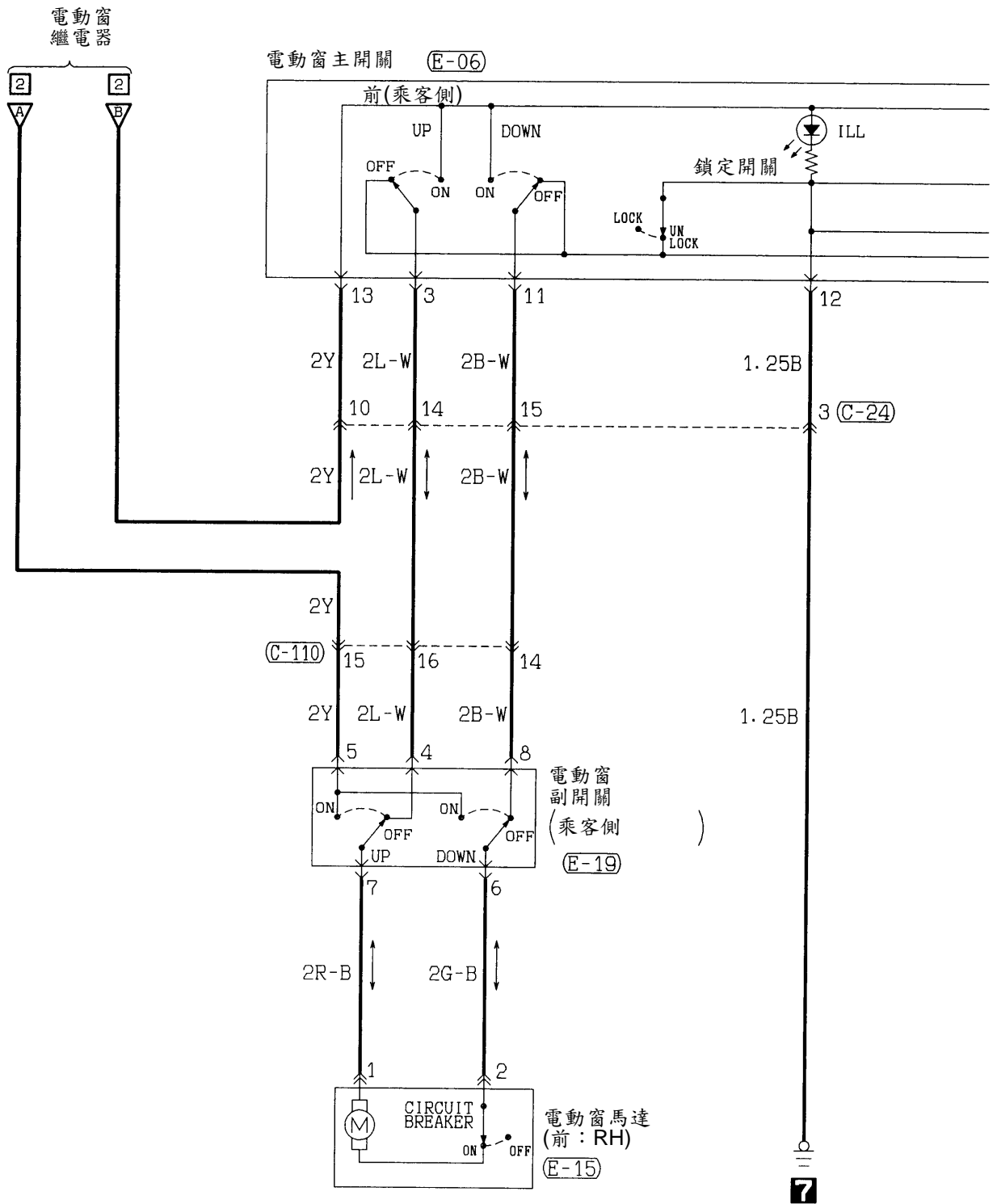

C-24

1	2	3	4	5	6
7	8	9	10	11	12
13	14	15	16	17	18
19	20				

C-110

1	2	3	4
5	6	7	8
9	10	11	12
13	14	15	16

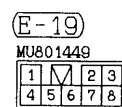
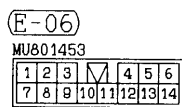

7

電動窗(續)

4

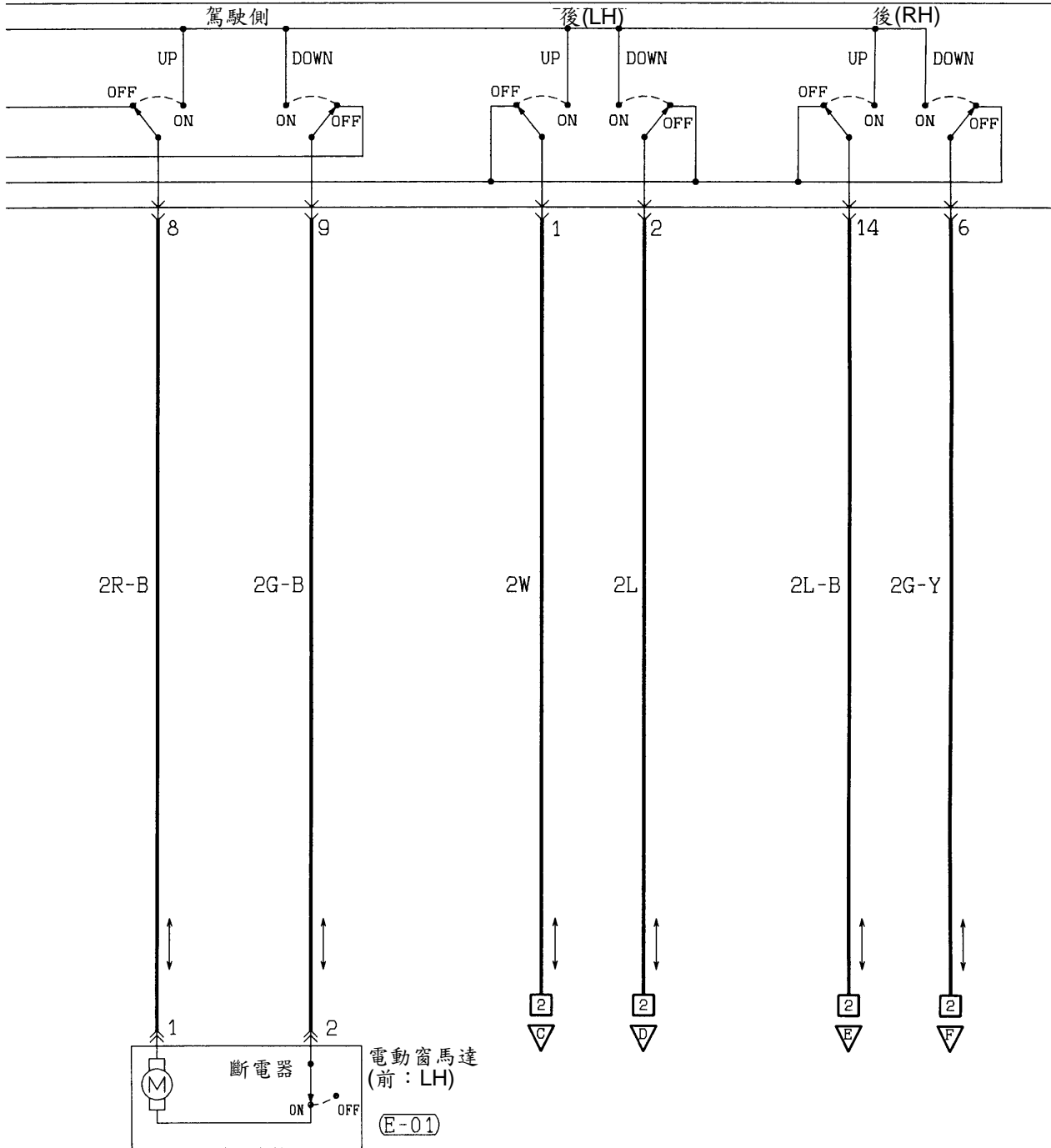

中控鎖

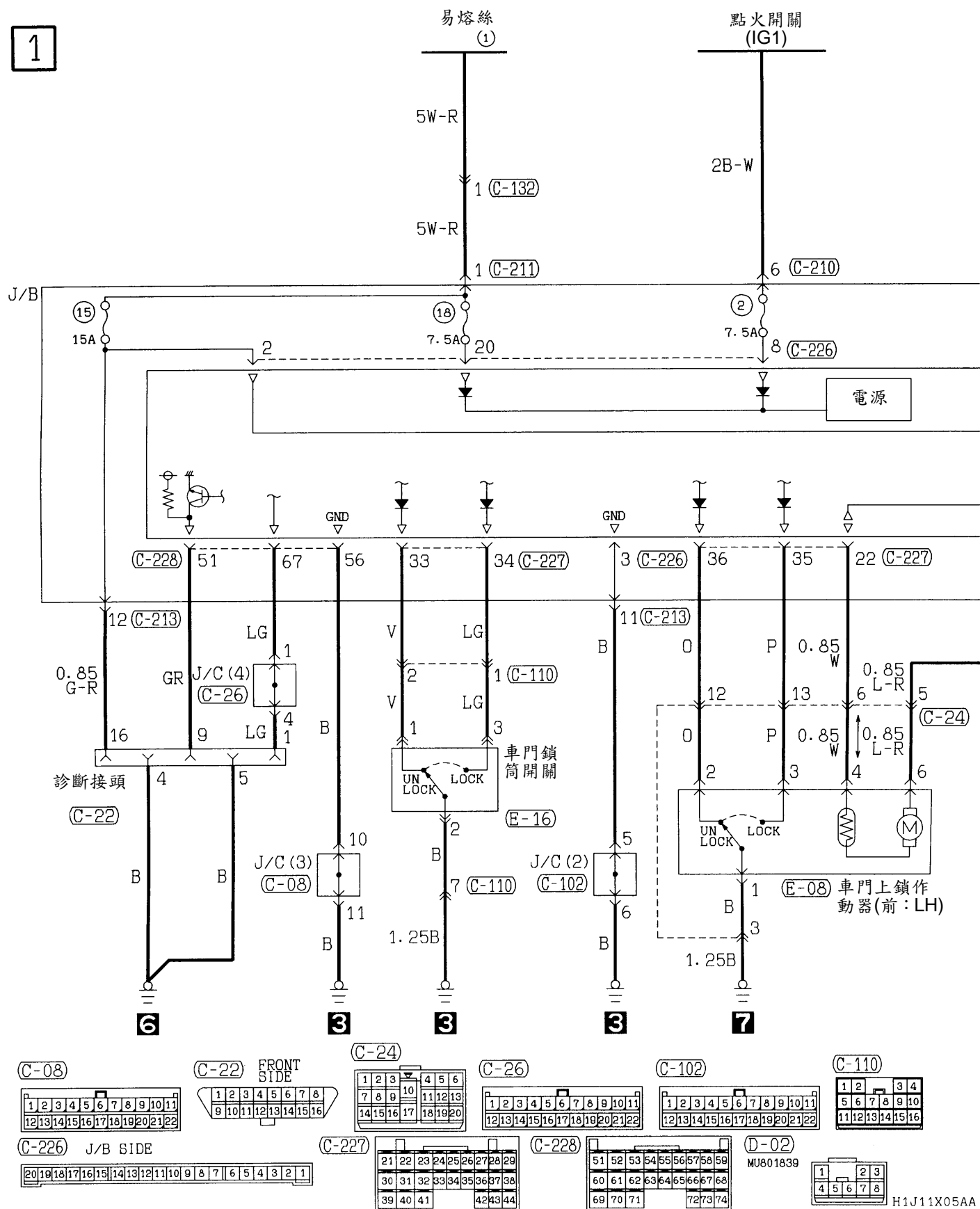

中控鎖(續)

2

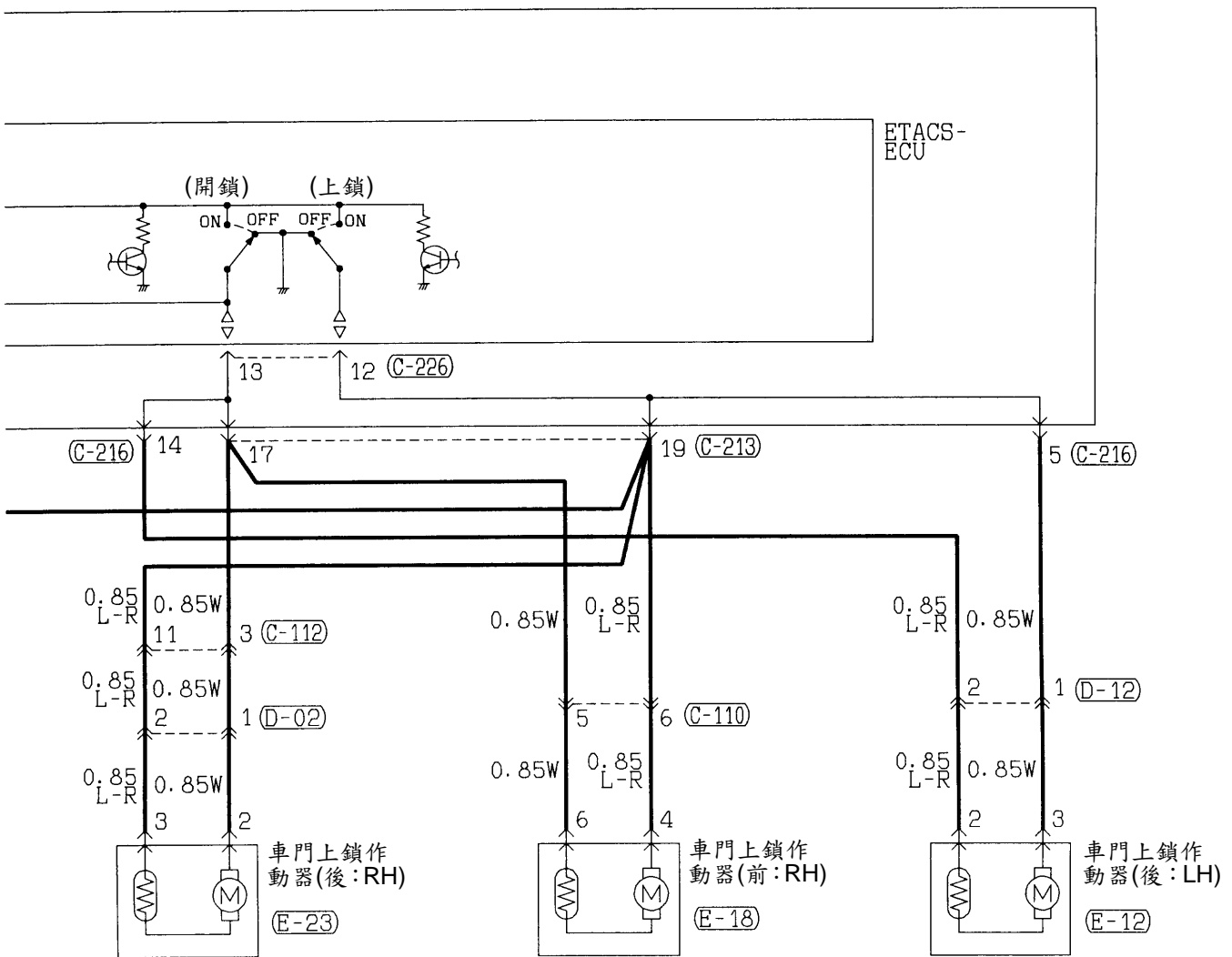

(C-112) MU801855

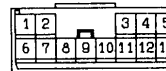

(D-12) MU801839

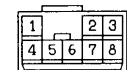

(C-132) (MU801380)

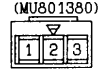

(E-08) MU802341



(C-210) MU801331



(E-12) MU802341



(C-211) MU801331



(E-16) MU802337



(C-213) MU802341



(E-18) MU802341

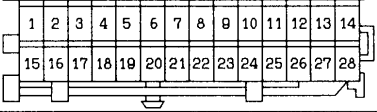

(E-23) MU802341



(C-216) MU801331



(E-12) MU802341



手動冷氣

1

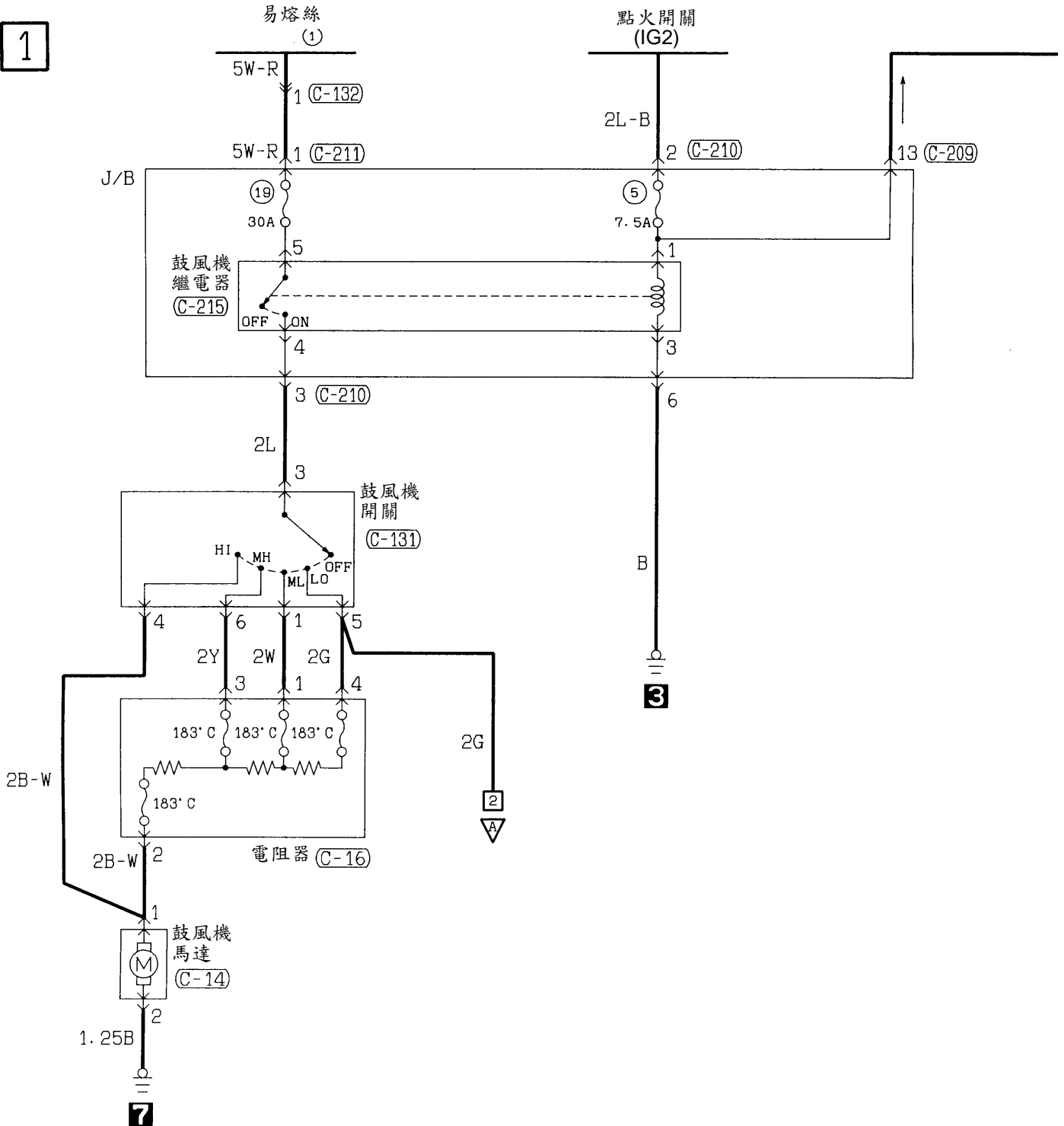

(C-05)

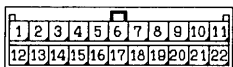

(C-08)

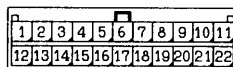

(C-10)



(C-14)



(C-16)



(C-135)



(C-209) MU801857

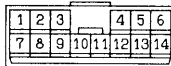

(C-210) MU801331



(C-211)



(C-213)

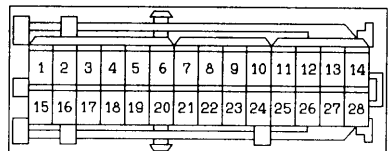

H1J12X06AA

手動冷氣 (續)

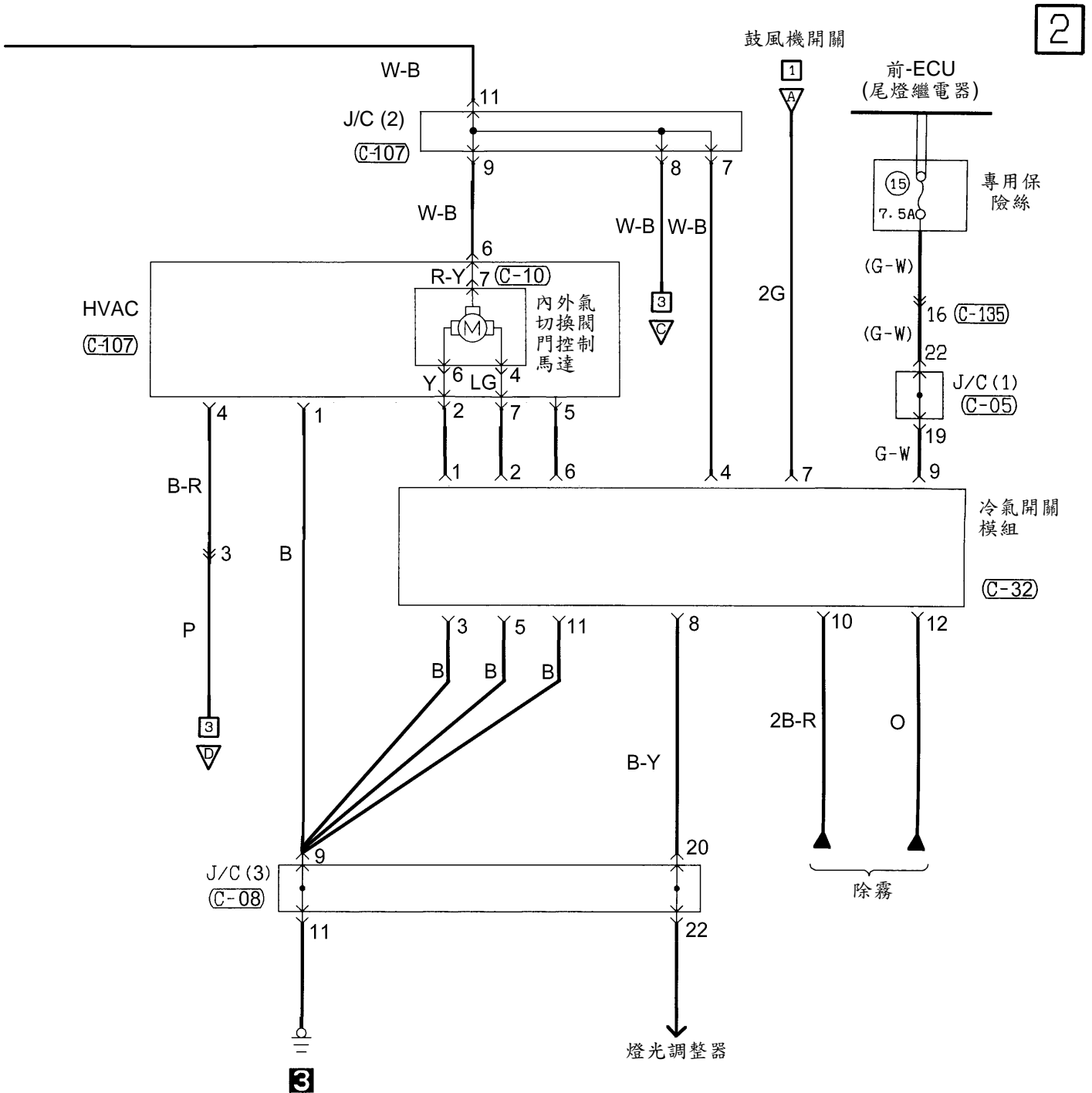

手動冷氣 (續)

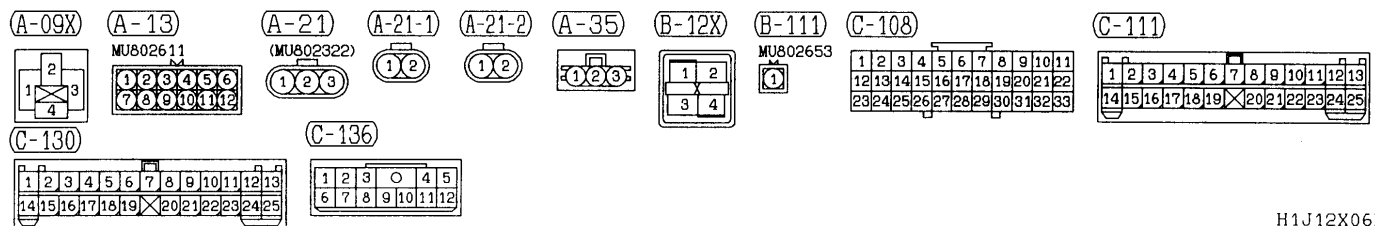
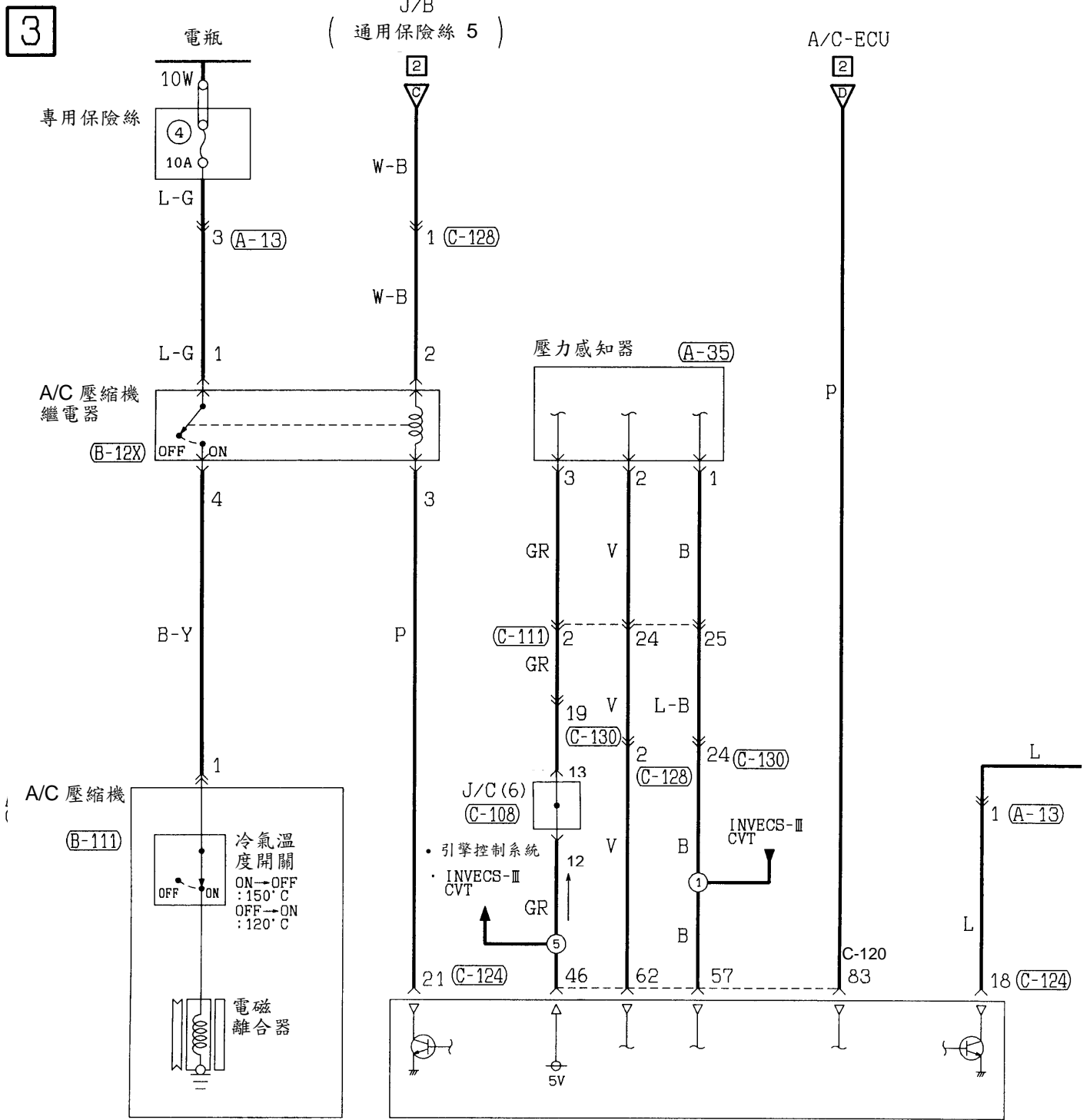

手動冷氣 (續)

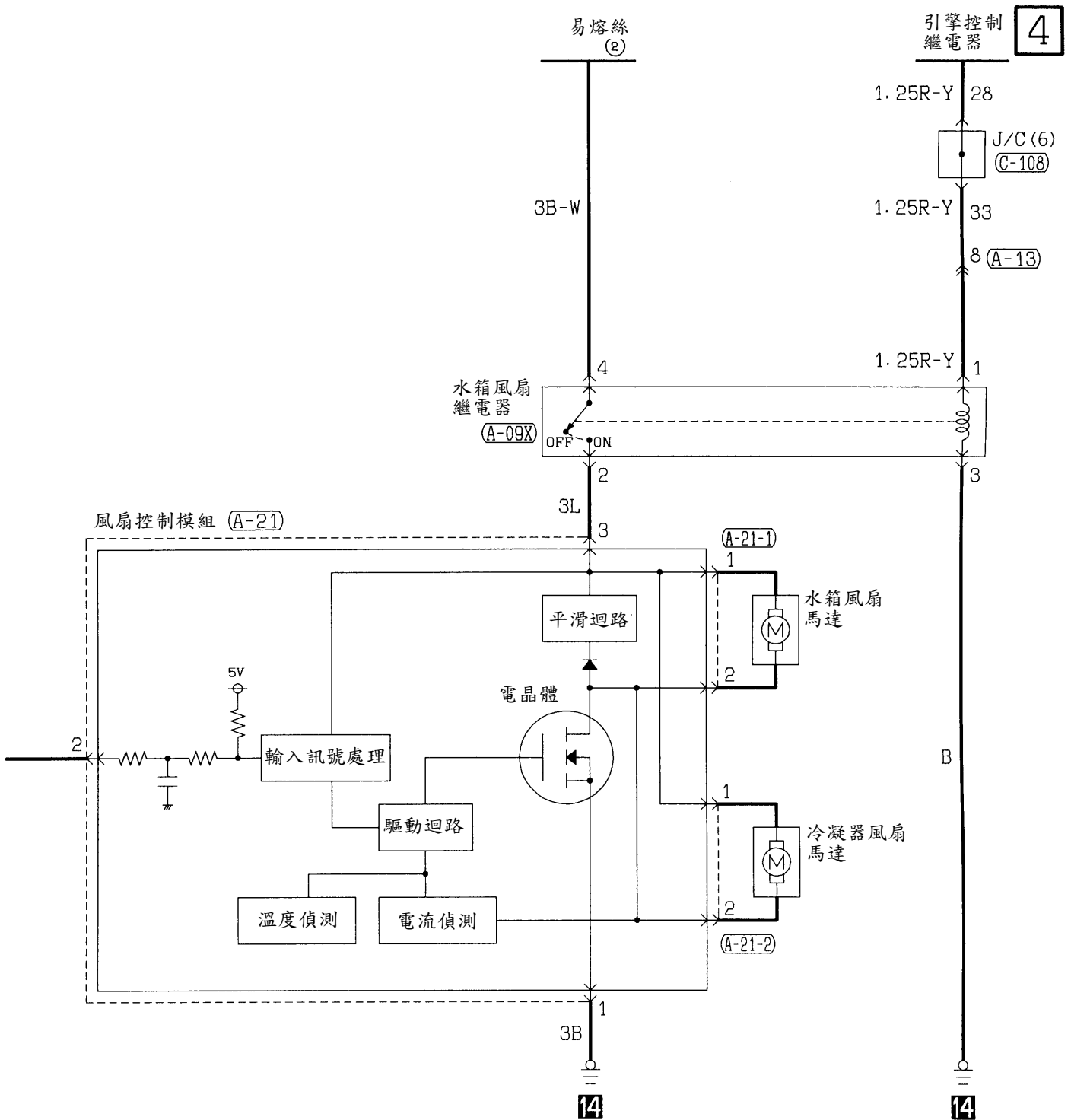

(C-116) (MU803782)

71	72	73	74	75	76	77					
78	79	80	81	82	83	84	85	86	87	88	89
90	91	92	93	94	95	96	97	98			

(C-120) (MU803781)

41	42	43	44	45	46					
47	48	49	50	51	52	53	54	55	56	57
58	59	60	61	62	63	64	65	66		

(C-124) (MU803784)

1	2	3	4	5	6	7	8							
9	10	11	12	13	14	15	16	17	18	19	20	21	22	23
24	25	26	27	28	29	30	31	32	33	34	35			

(C-128)

1	2	3	4	5	6	7	8	9	10	11
12	13	14	15	16	17	18	19	20	21	22

自動冷氣

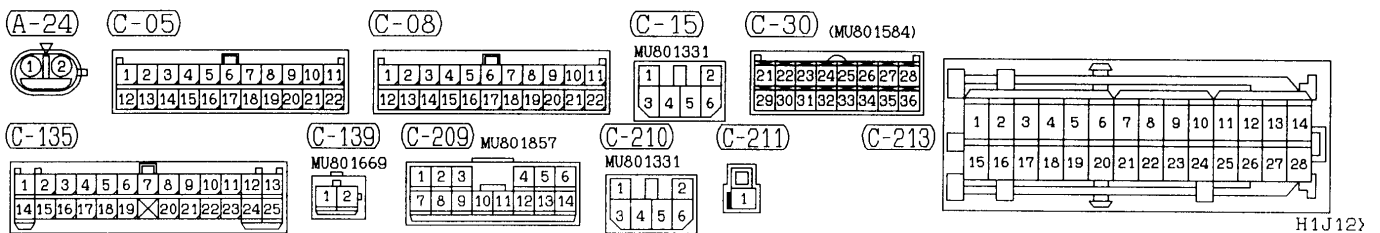
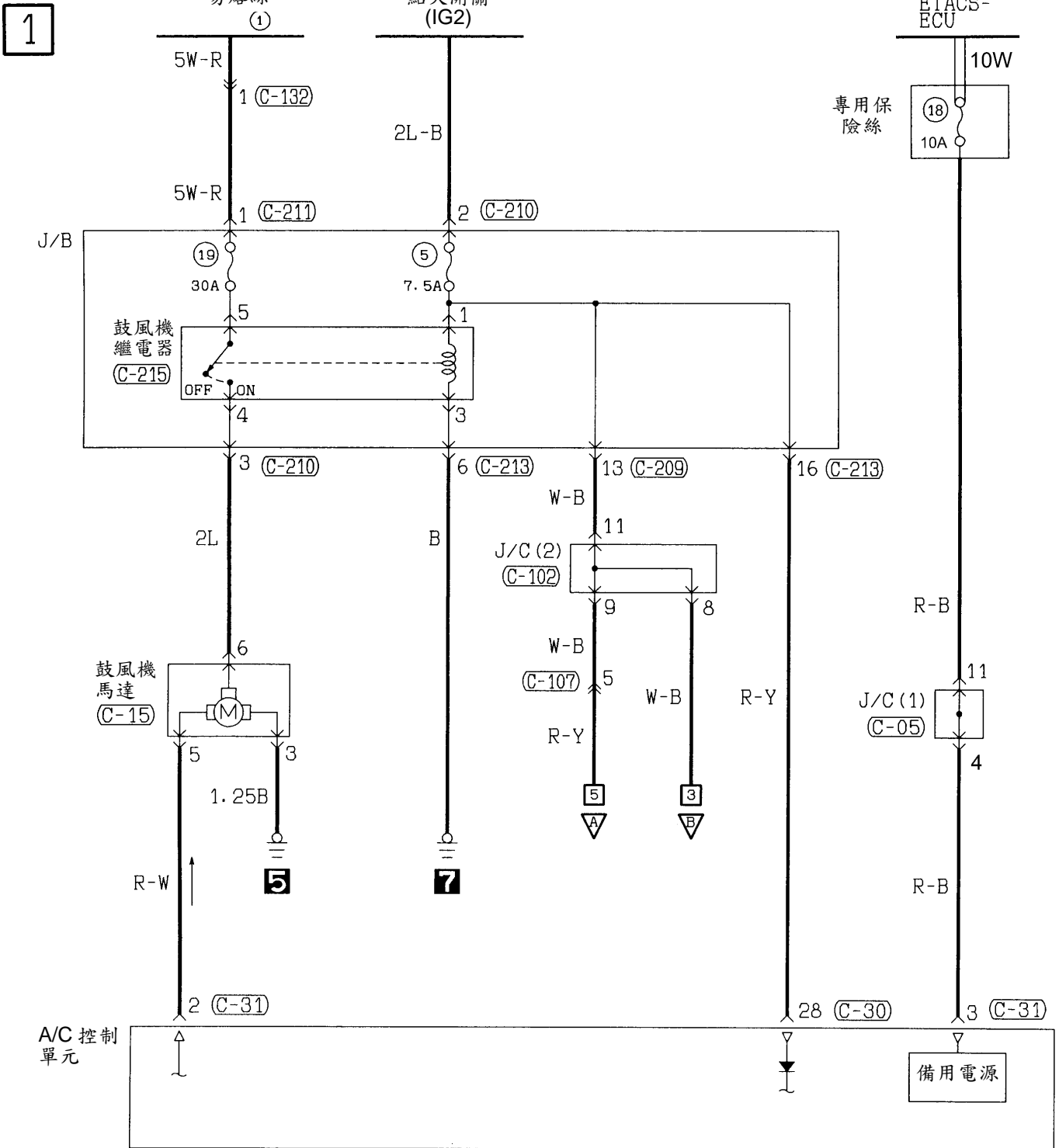

自動冷氣 (續)

2

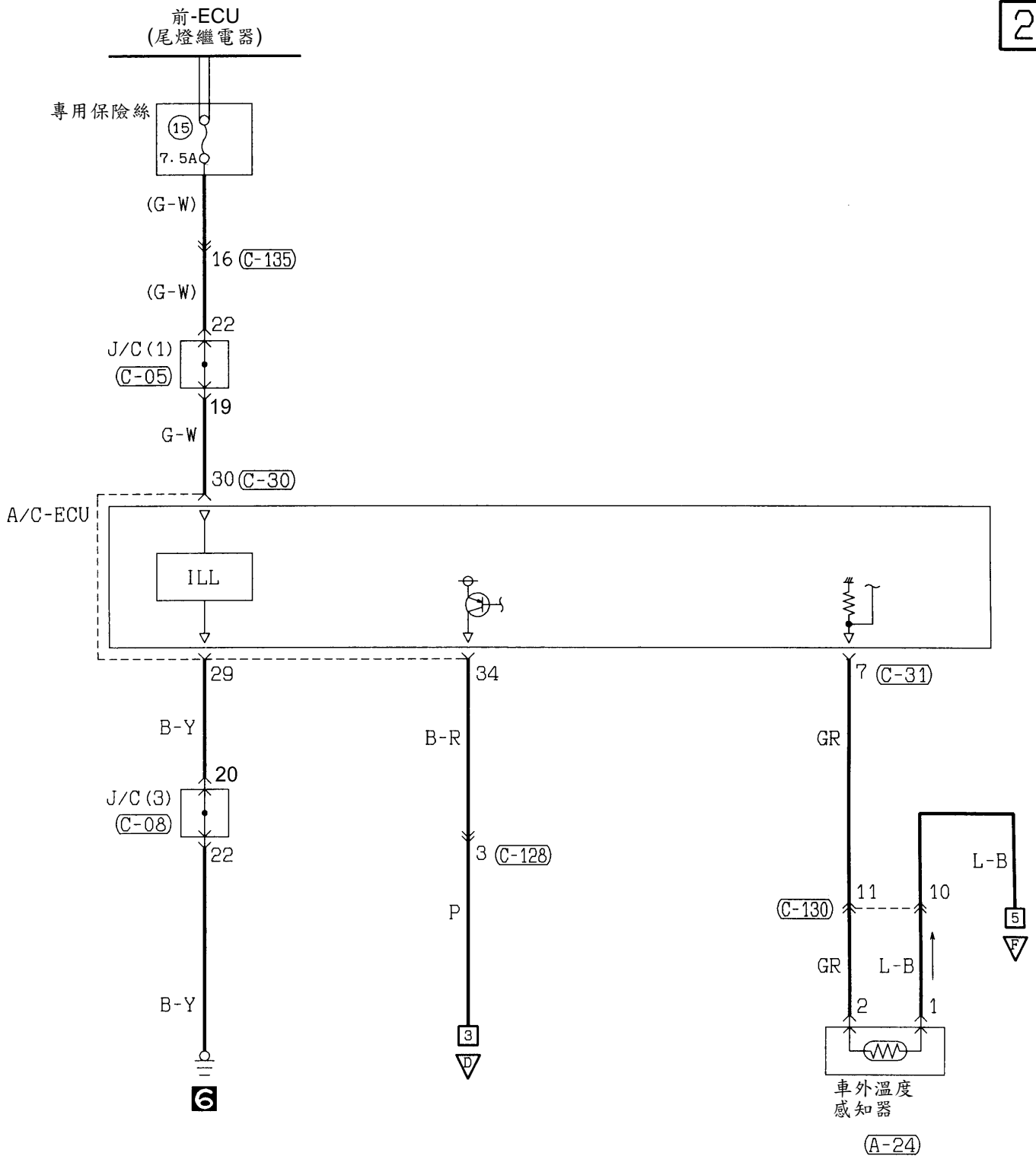

(C-31) (MU801585)

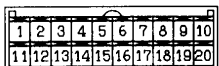

(C-35) (MU801380)



(C-102)

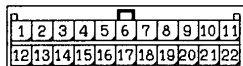

(C-107) MU801855

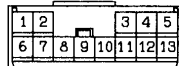

(C-128)

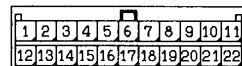

(C-132) (MU801380)



(C-215)



自動冷氣 (續)

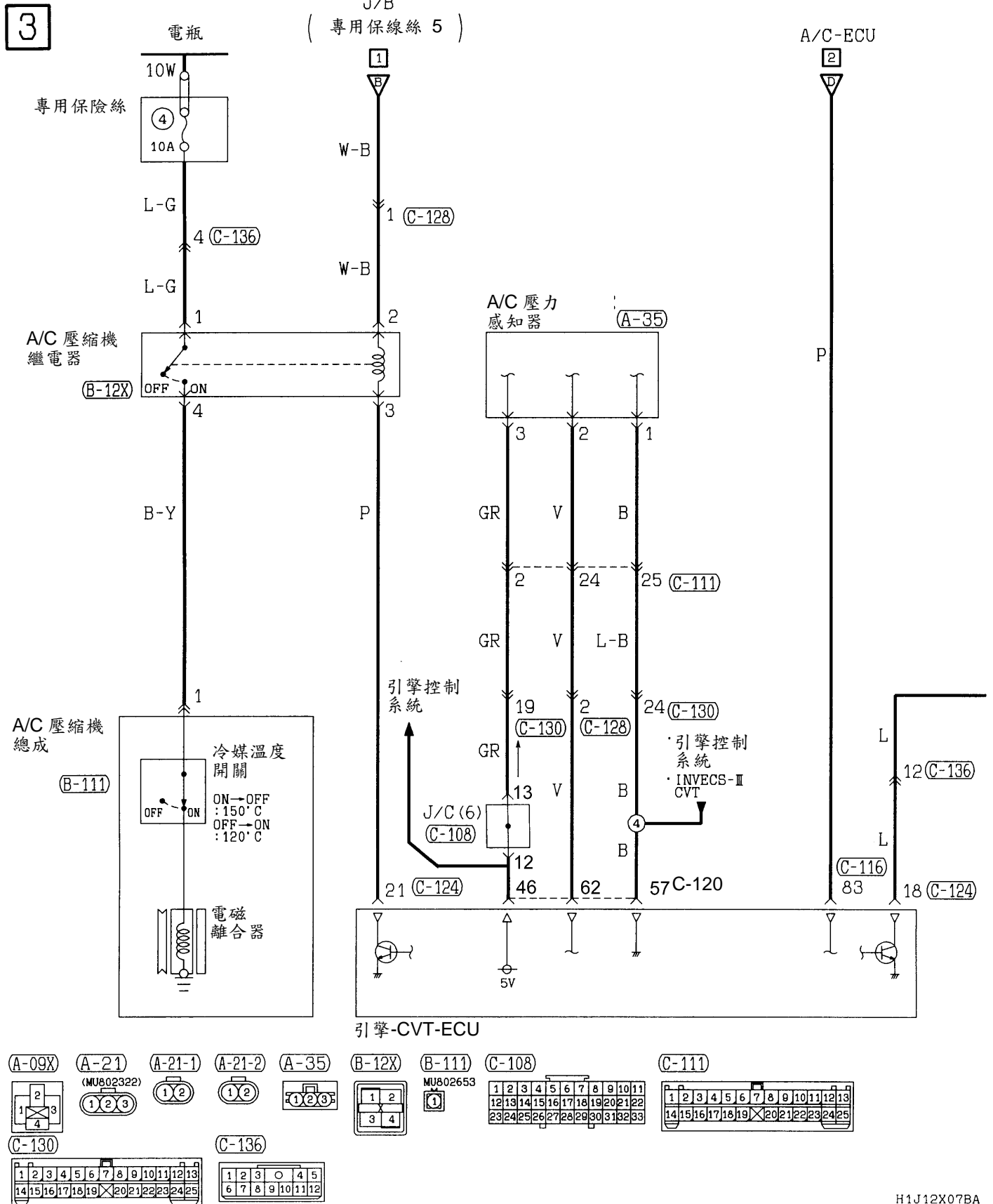

自動冷氣 (續)

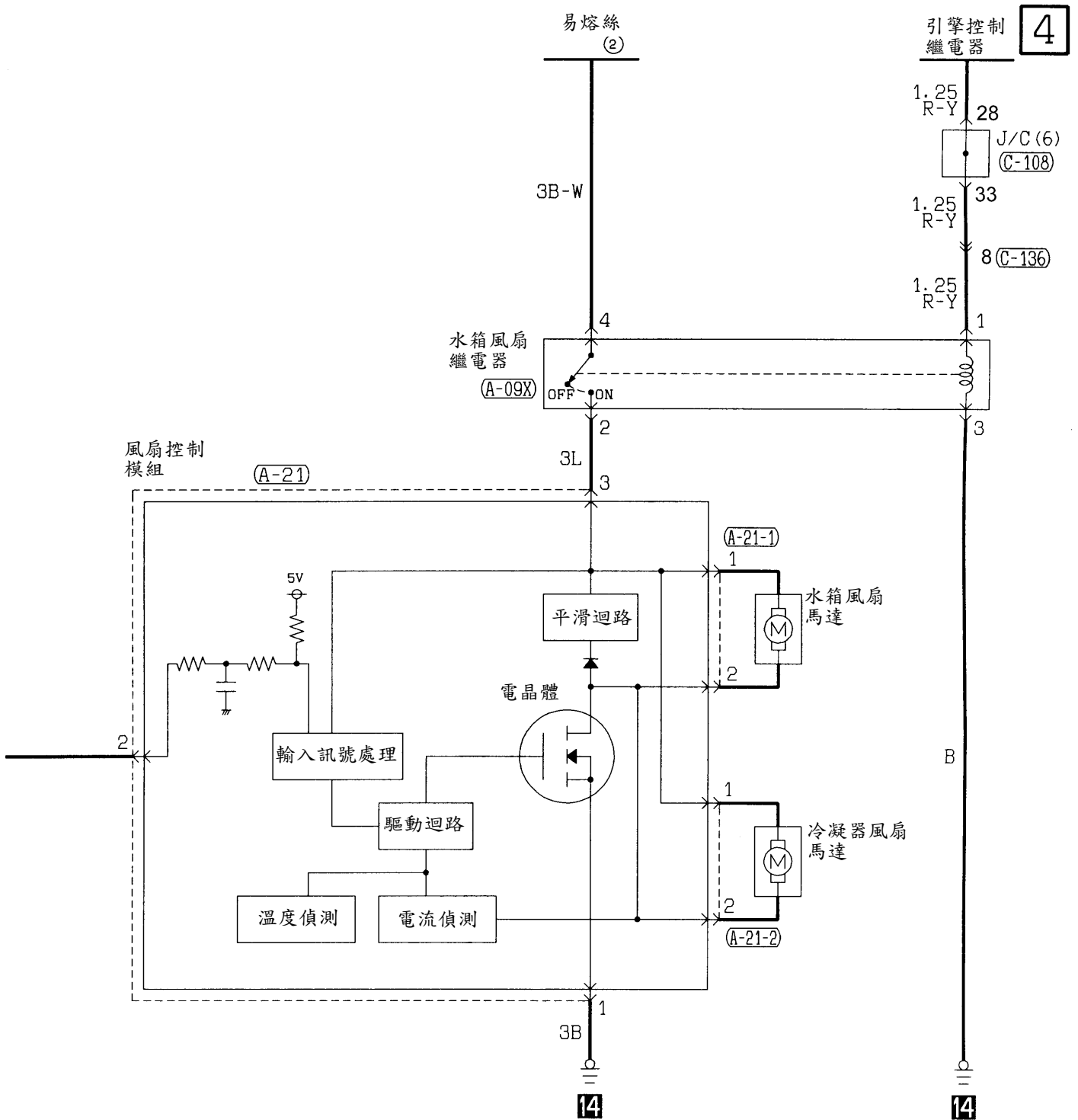

(C-116) (MU803782)

71	72	73	74		75	76	77				
78	79	80	81	82	83	84	85	86	87	88	89
90	91	92	93	94	95	96	97	98			

(C-120) (MU803781)

41	42	43			44	45	46			
47	48	49	50	51	52	53	54	55	56	57
58	59	60	61	62	63	64	65	66		

(C-124) (MU803784)

1	2	3	4		5	6	7	8						
9	10	11	12	13	14	15	16	17	18	19	20	21	22	23
24	25	26	27	28	29	30	31	32	33	34	35			

(C-128)

1	2	3	4	5	6	7	8	9	10	11
12	13	14	15	16	17	18	19	20	21	22

自動冷氣 (續)

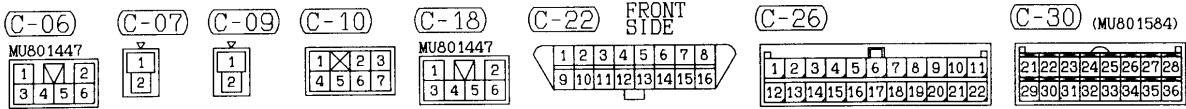
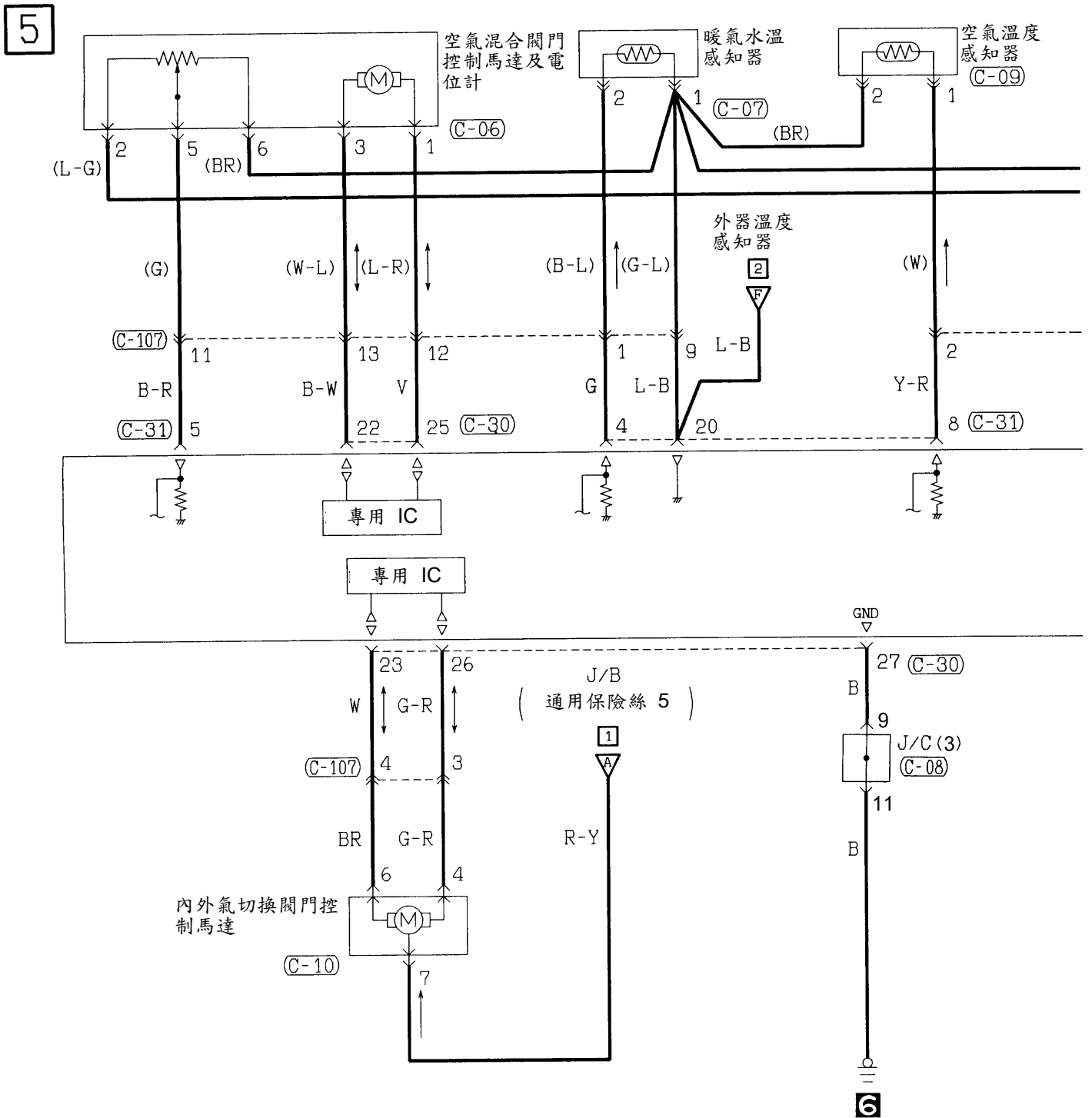

自動冷氣 (續)

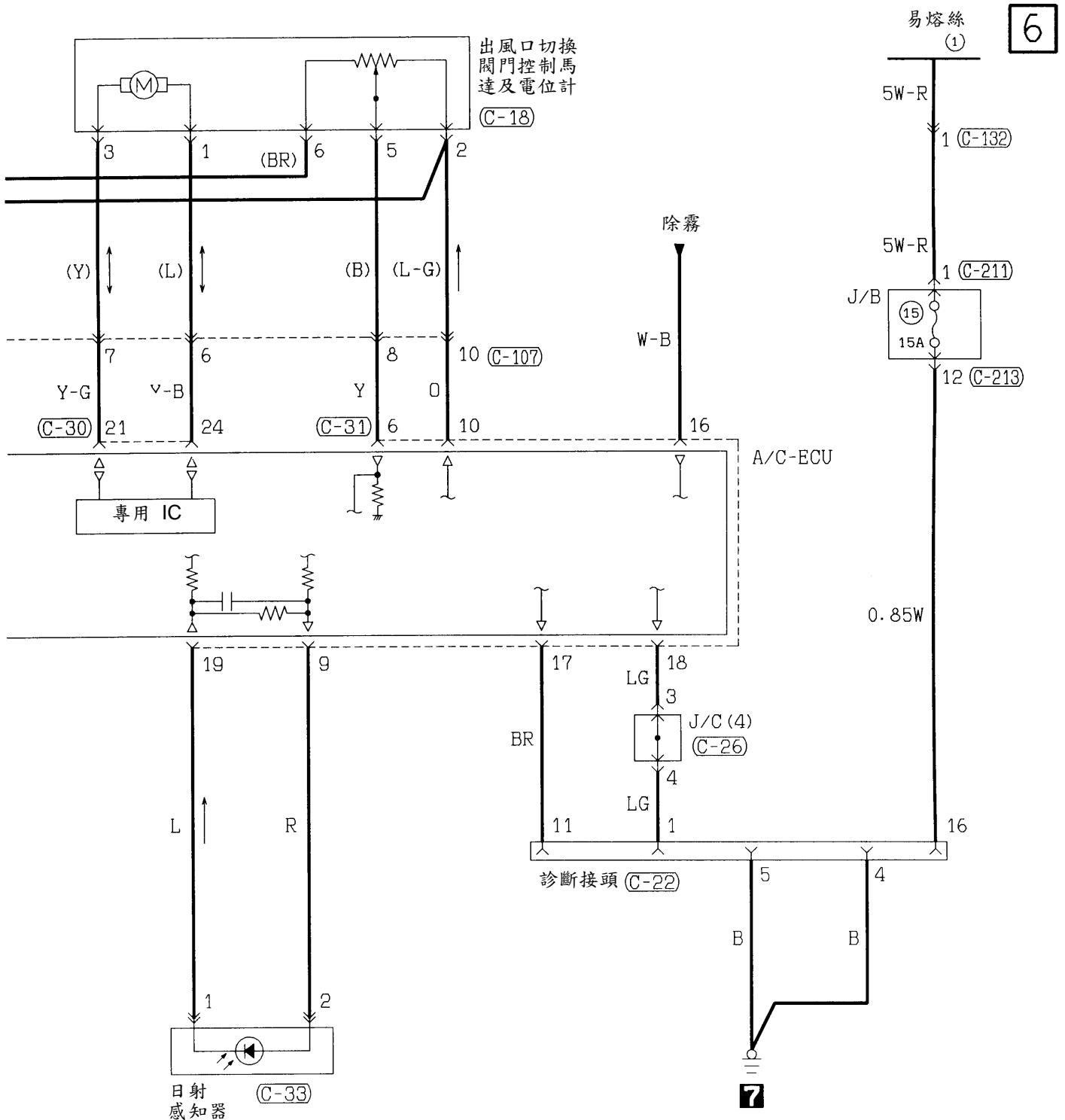

(C-31) (MU801585)

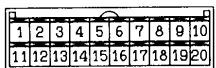

(C-33) MU801696

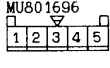

(C-35) (MU801380)



(C-107) MU801855

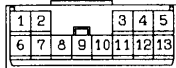

(C-132) (MU801380)



(C-211)



(C-213)

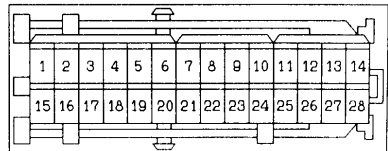

Wire colour code
 B : Black LG : Light green G : Green L : Blue
 BR : Brown O : Orange GR : Gray R : Red
 W : White SB : Sky blue P : Pink Y : Yellow

擋風玻璃雨刷及清洗器

1

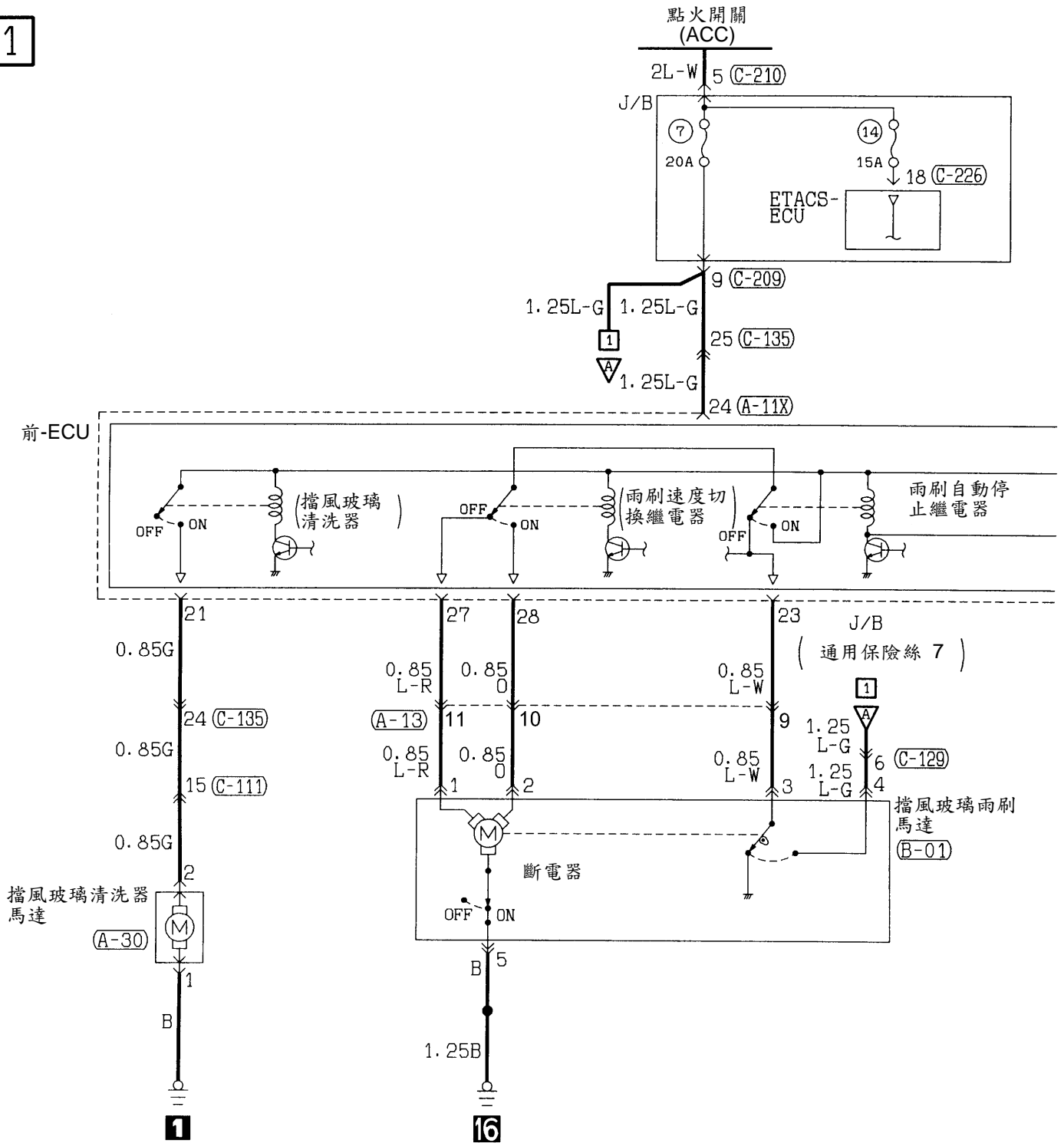

(A-11X)

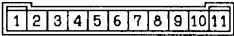

(A-12X)

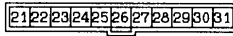

(A-13)

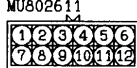

(A-30)



(B-01)



(C-05)

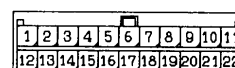

(C-08)

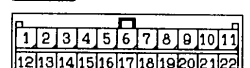

(C-129)

(MU801846)

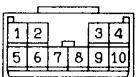

(C-135)

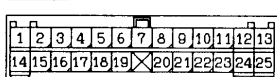

(C-203)

(MU801514)

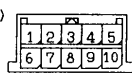

(C-209)

(MU801857)

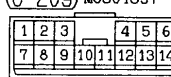

(C-210)

(MU801331)



檔風玻璃雨刷及清洗器(續)

2

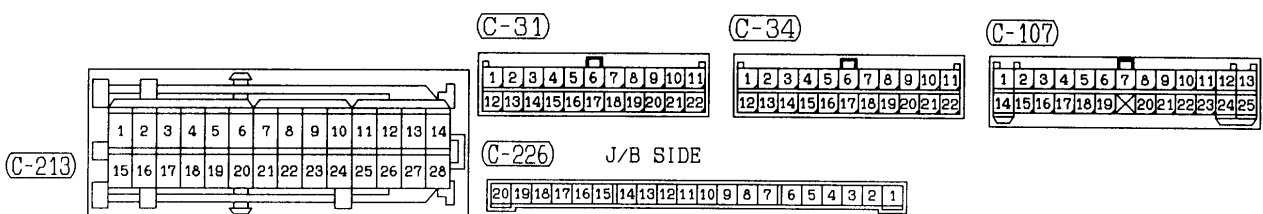
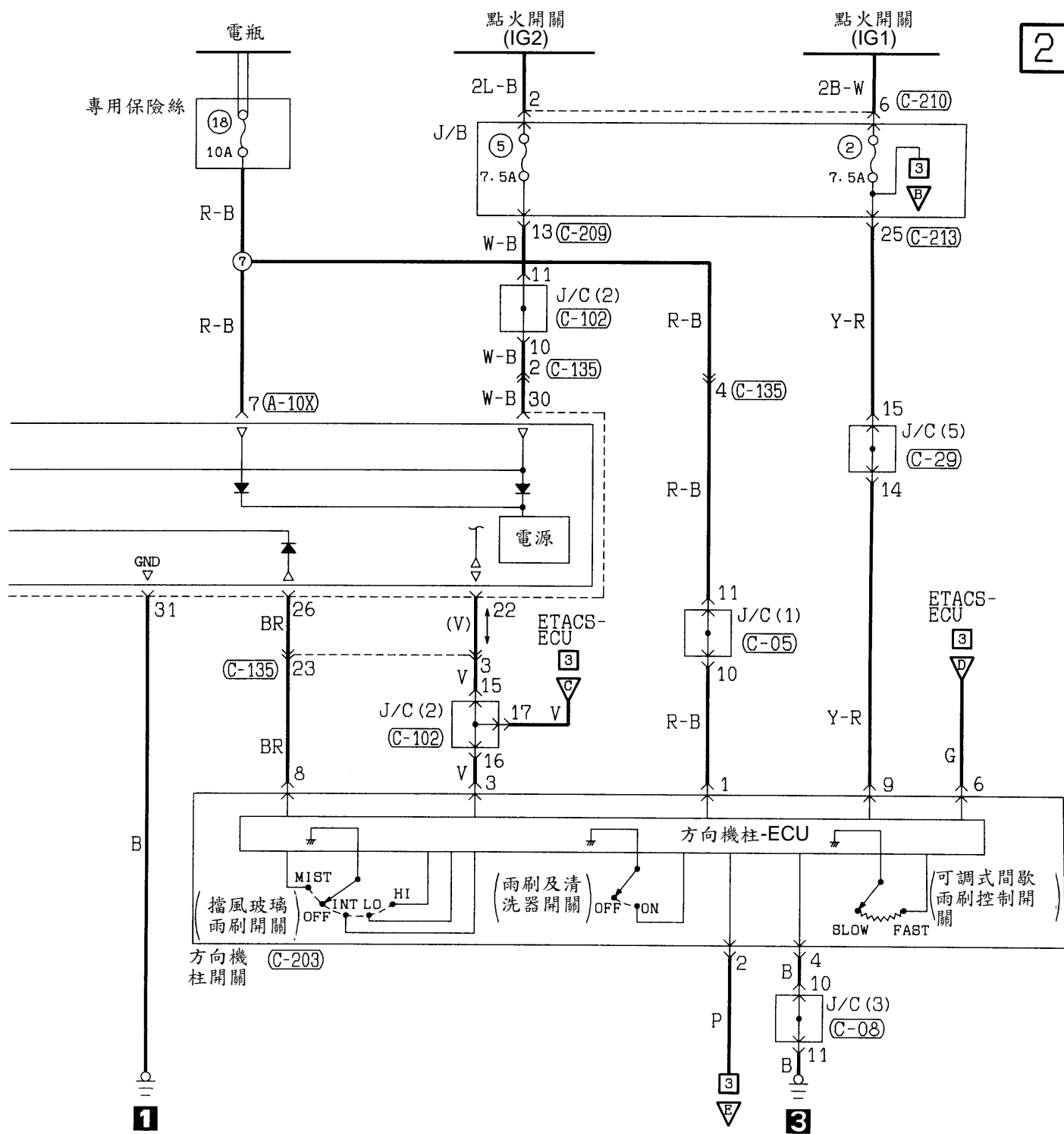

檔車玻璃刮刷及清洗器(續)

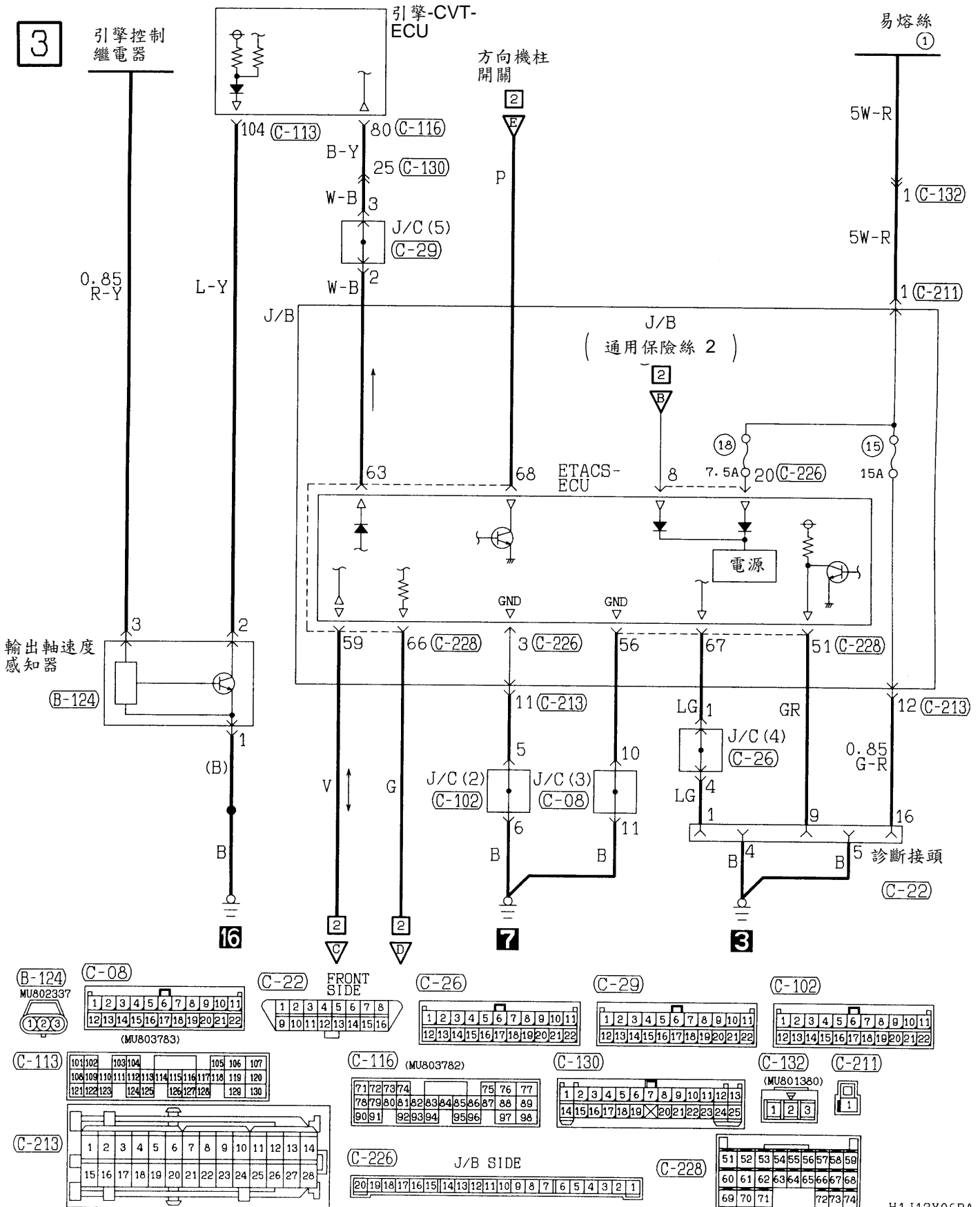

除霧器(手動空調)

1

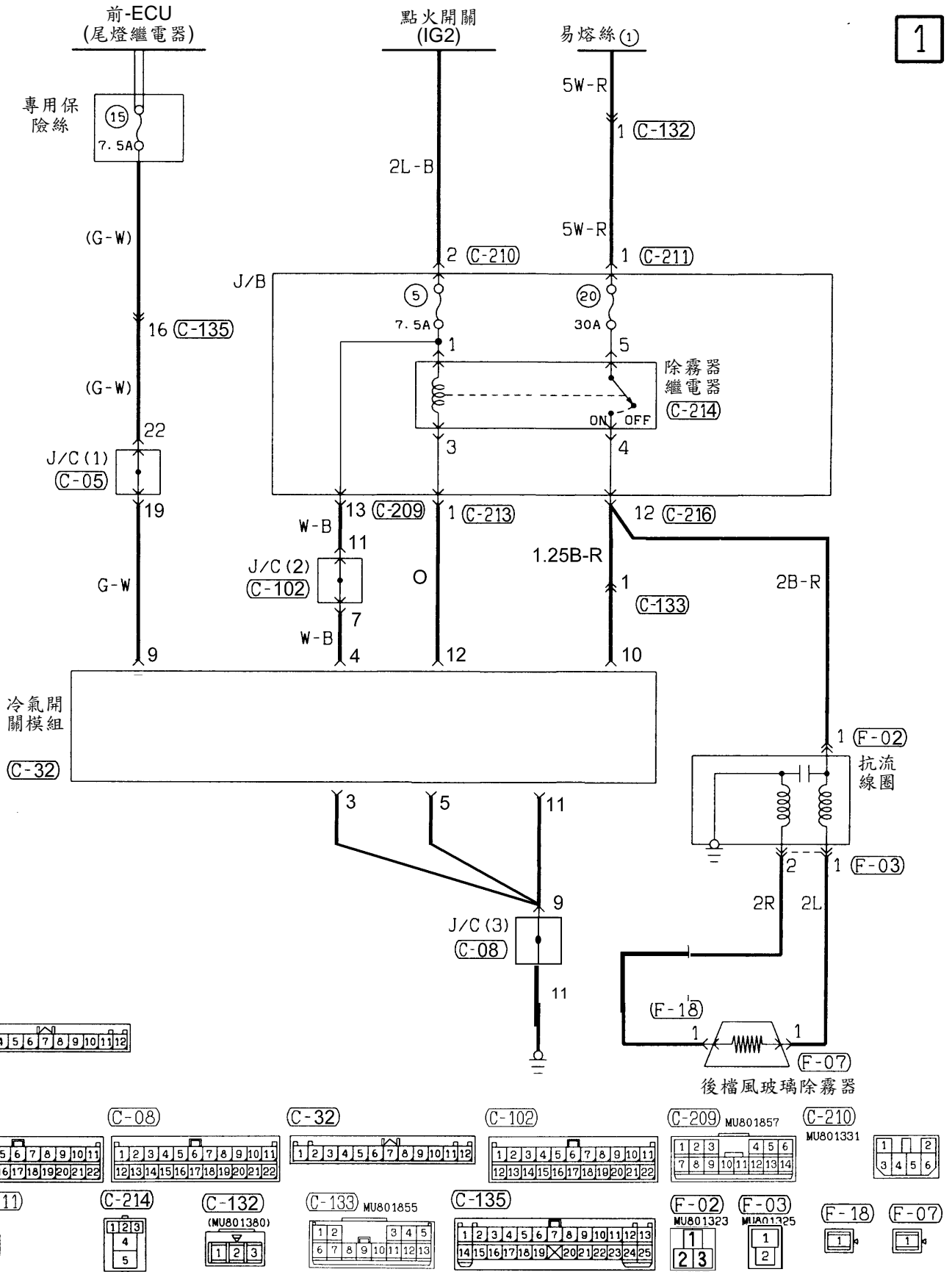

後擋風玻璃、車門後視鏡、除霧線(自動空調)

1

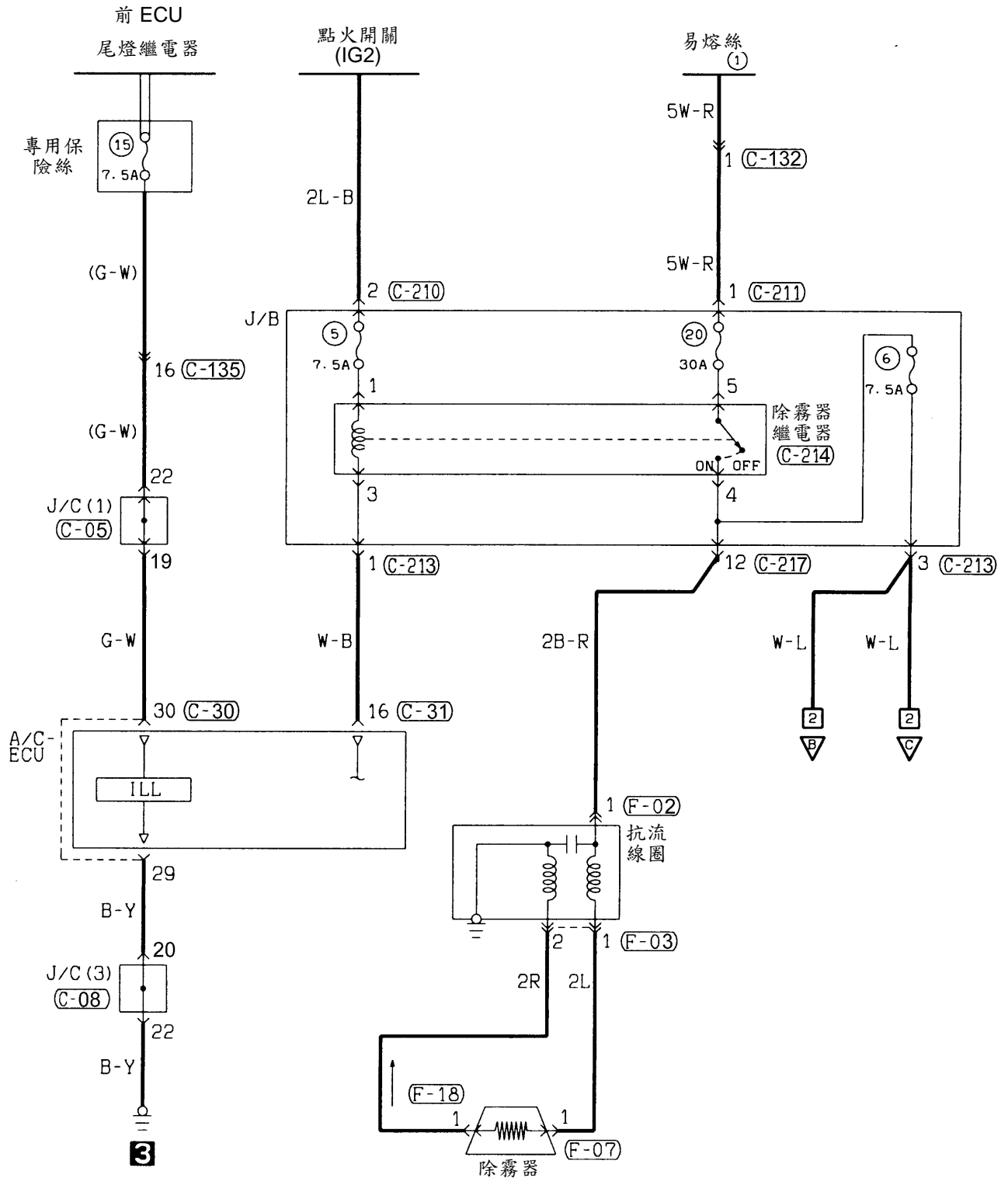

(C-05)

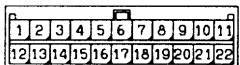

(C-31) (MU801585)

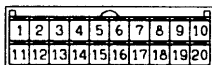

(C-30) (MU801584)

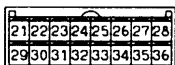

(C-132) (MU801380)



(C-135)

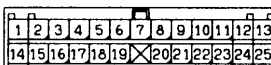

(C-110)



(C-217)

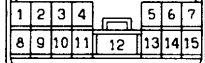

(E-02)



(E-13)

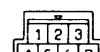

(F-02)

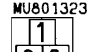

(F-03)

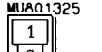

(F-18)



(F-07)



後擋風玻璃、車門後視鏡、除霧線(自動空調)(續)

2

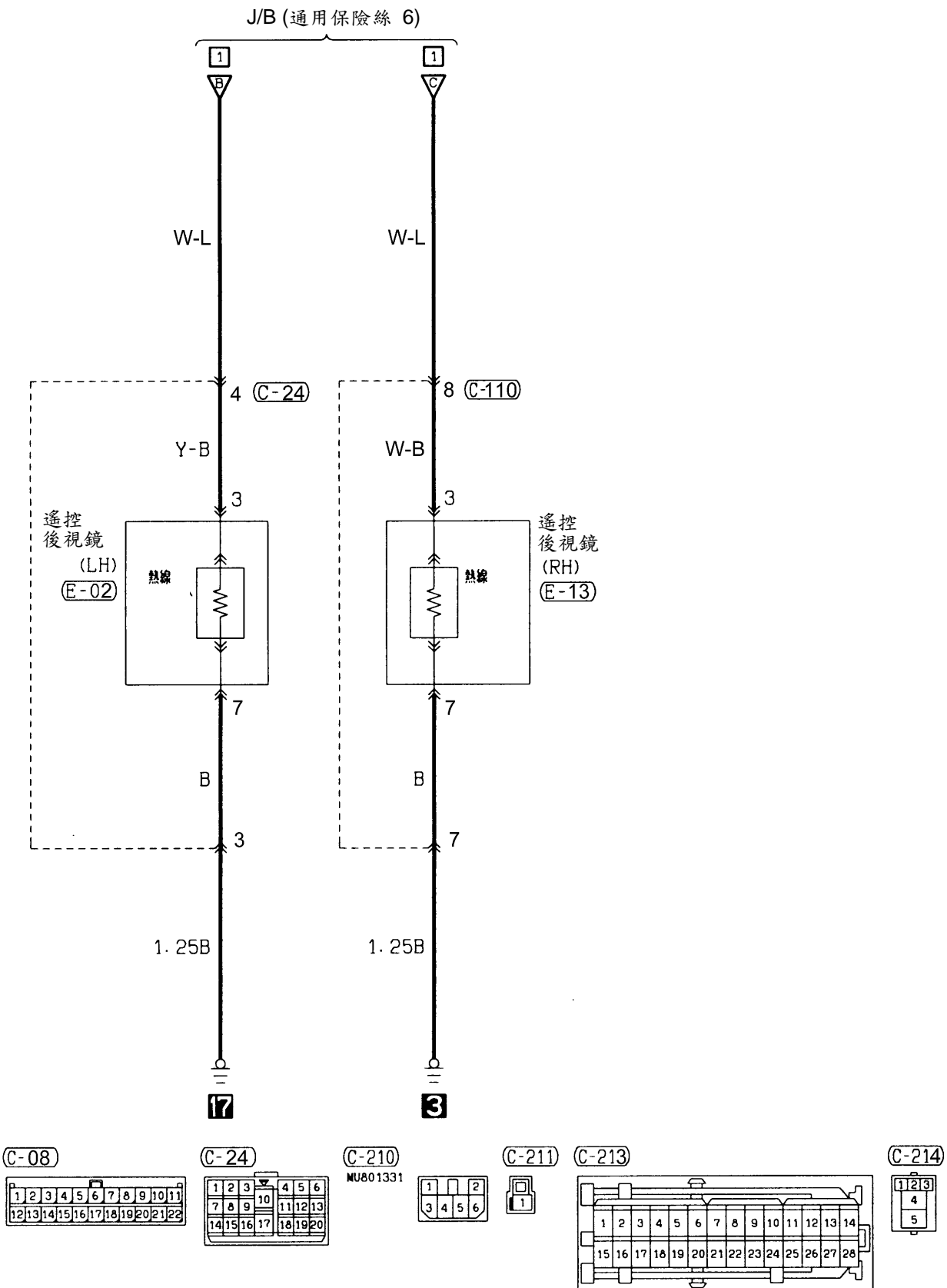

遙控後視鏡

1

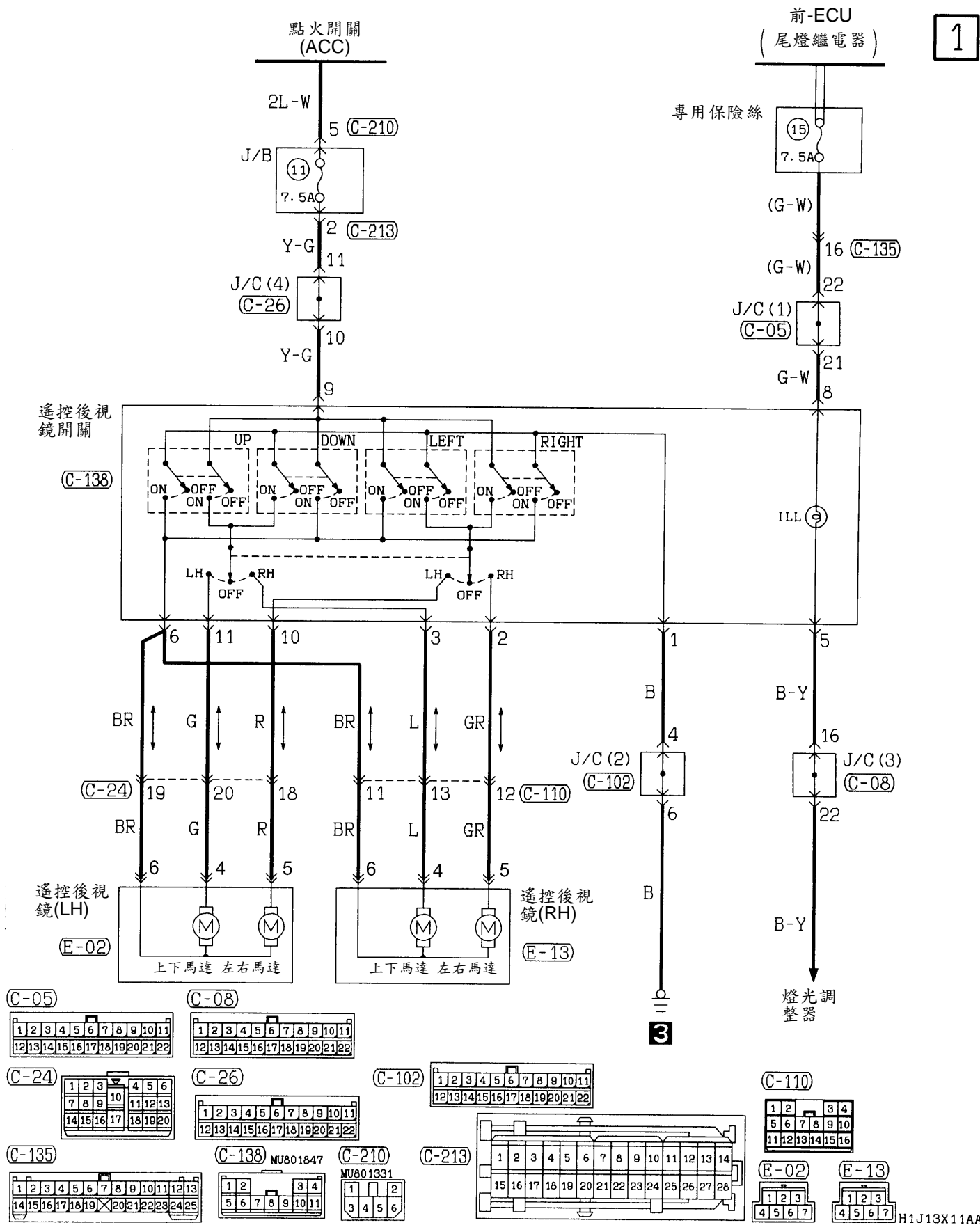

時鐘

1

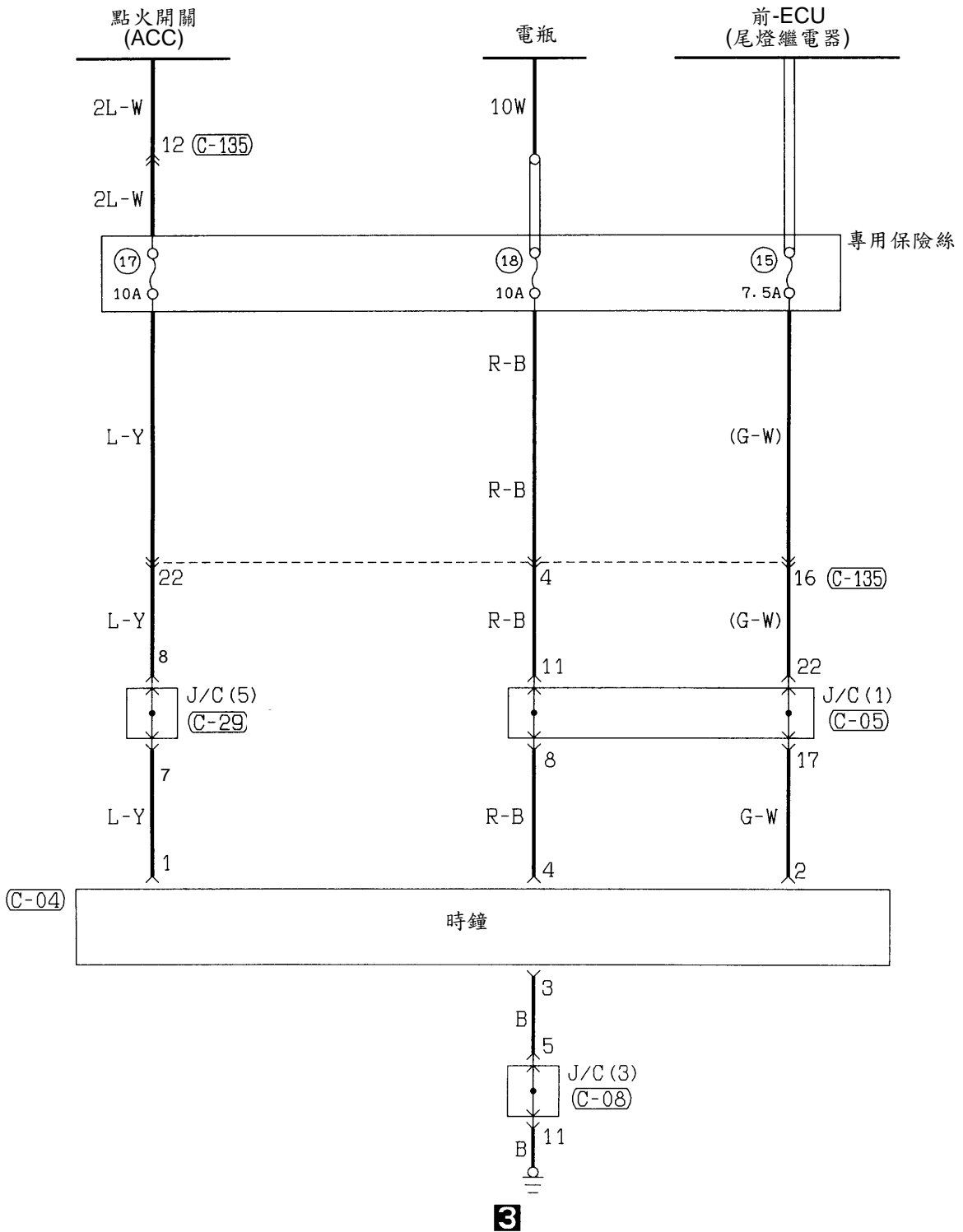

3

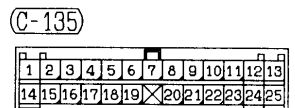
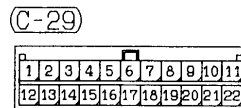
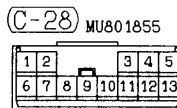
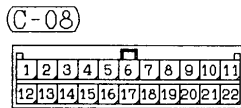
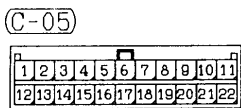
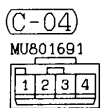

點煙器及煙灰盒點煙燈

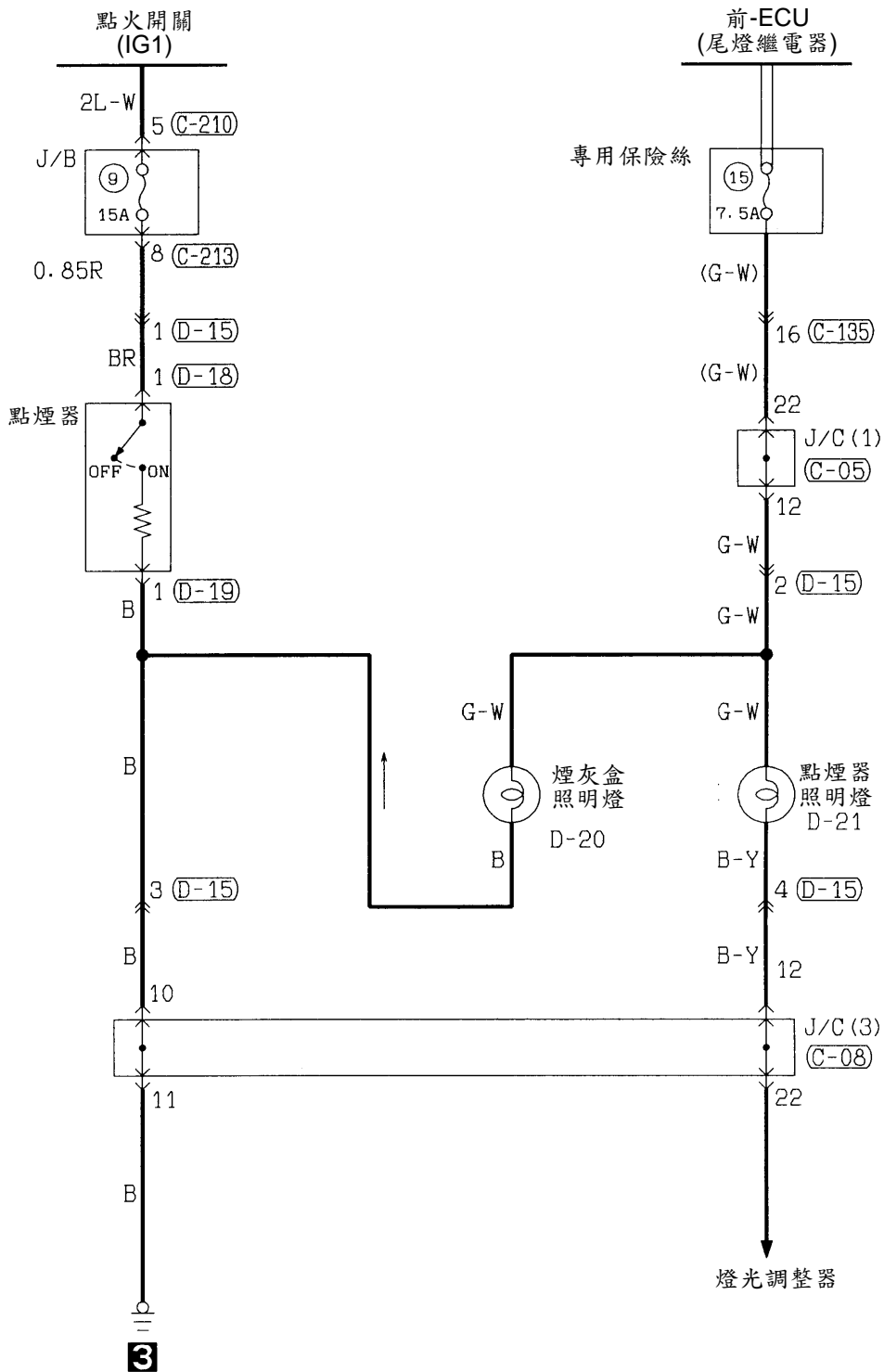

1

(C-05)

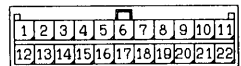

(D-15)
MU801687



(D-18)



(C-08)

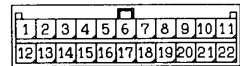

(D-19)
(MU801211)



(C-135)

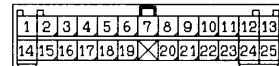

(C-210)



(C-213)

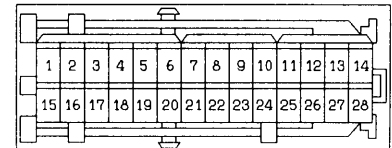

H1J14X08A

ABS

1

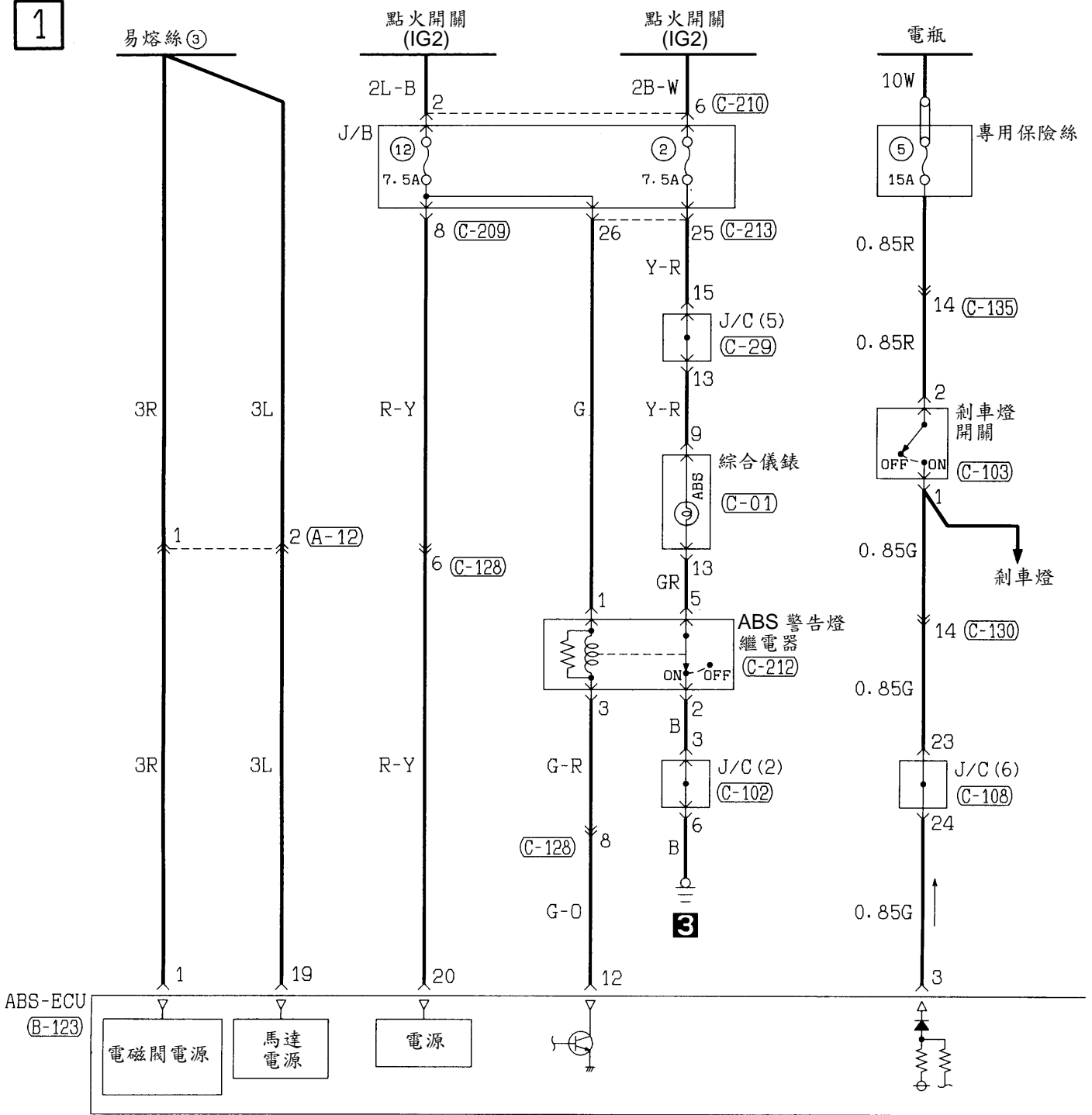

(A-12)

(B-123)

(C-01)

(C-29)

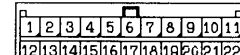
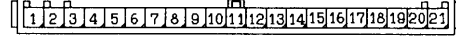

(C-135)

(C-209) MU801857

(C-210) MU801331

(C-212)

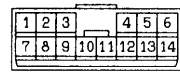
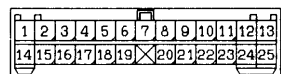

ABS(續)

液壓單元

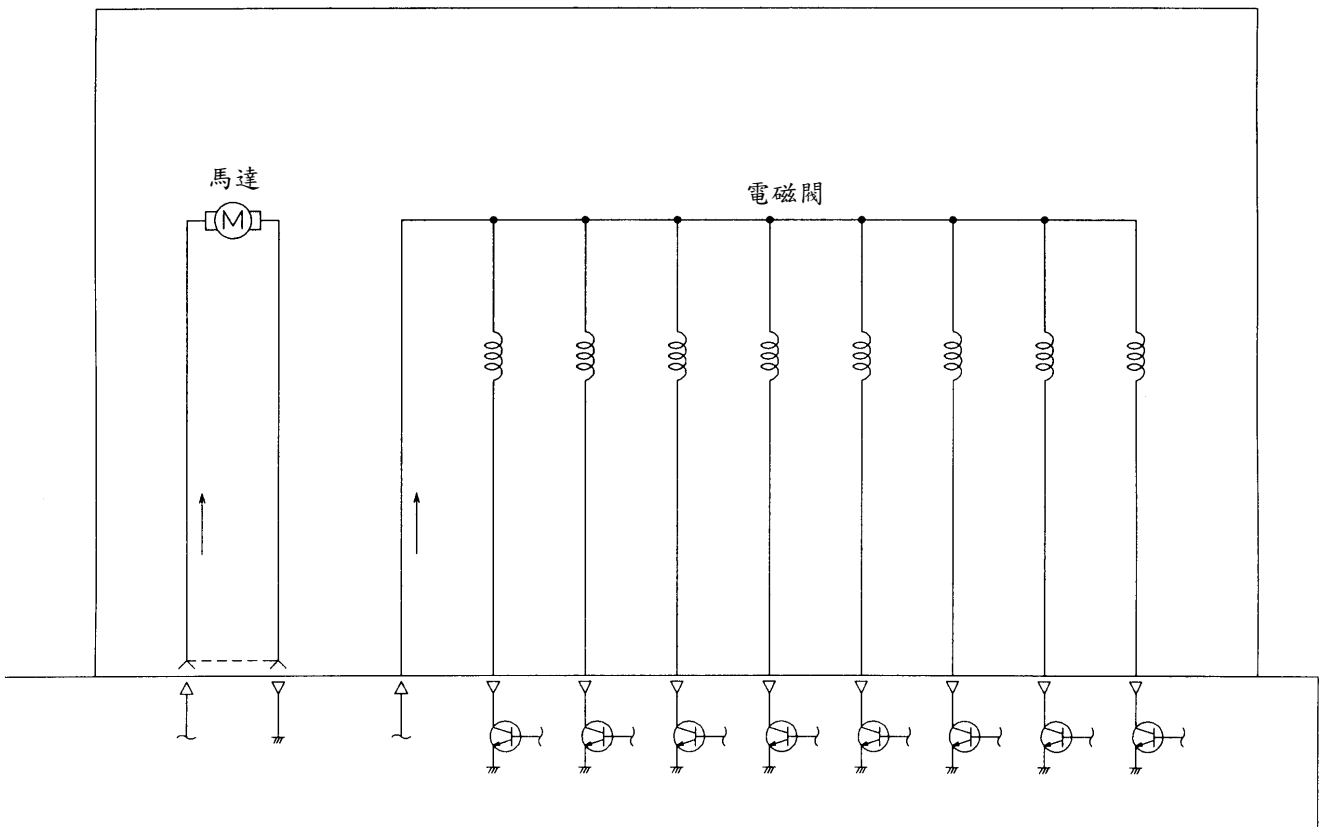

(C-102)

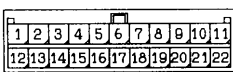

(C-103)



(C-108)



(C-128)

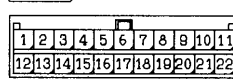

(C-130)

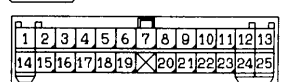

(C-213)

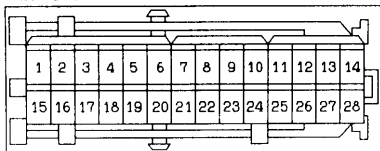

ABS(續)

3

車輪速度
感知器

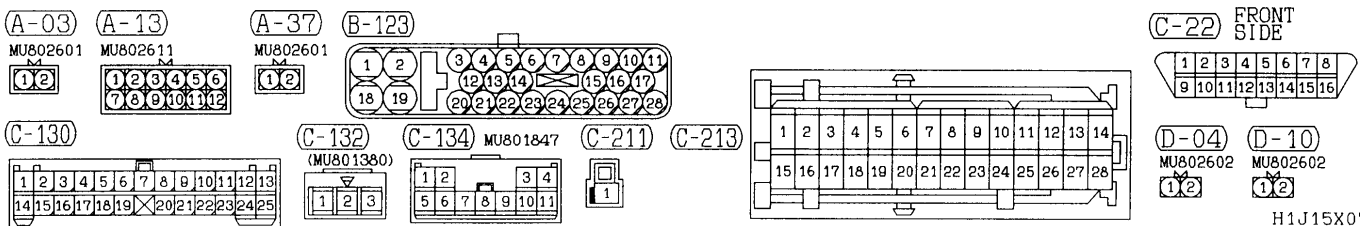
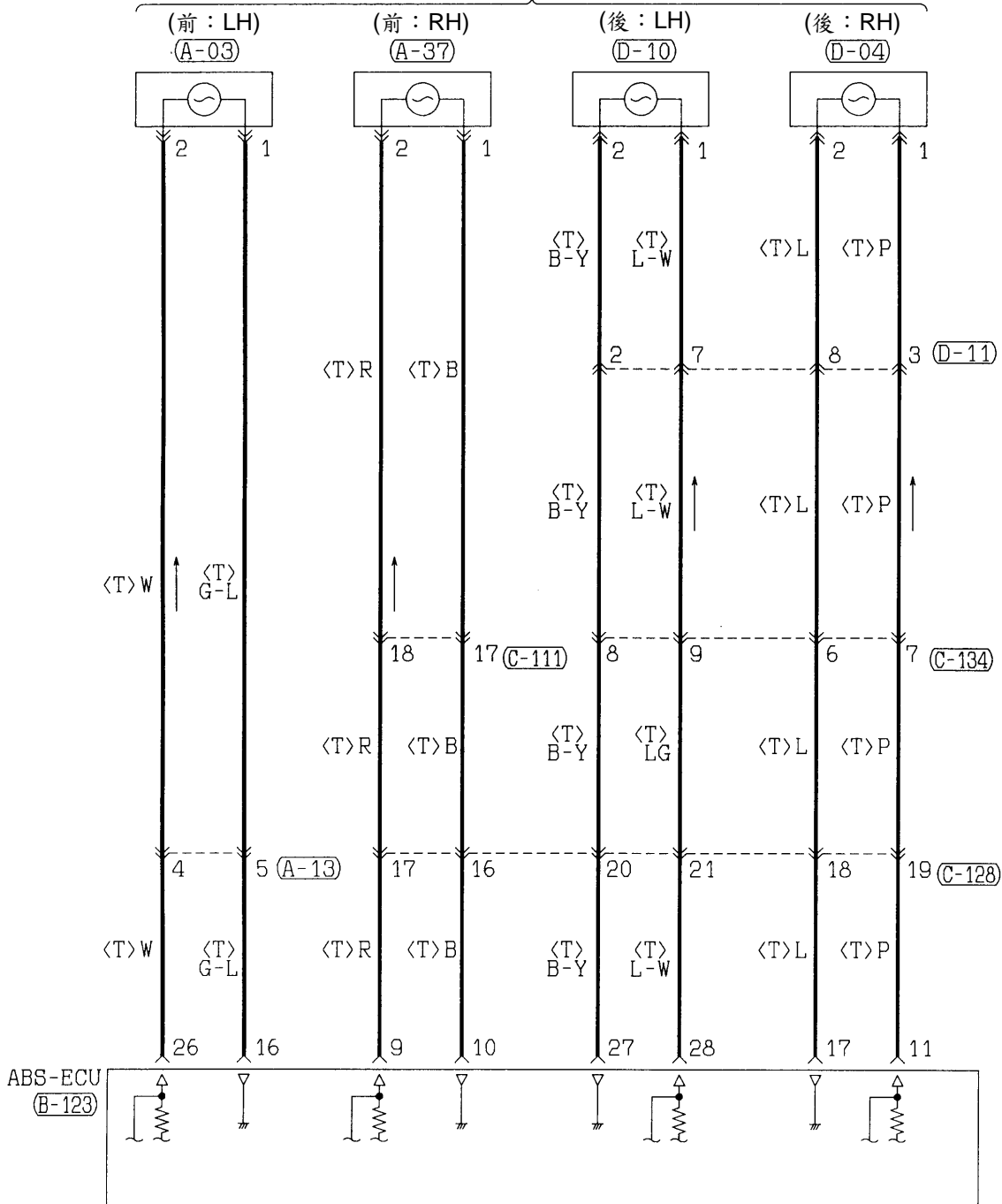

H1J15X0'

ABS(續)

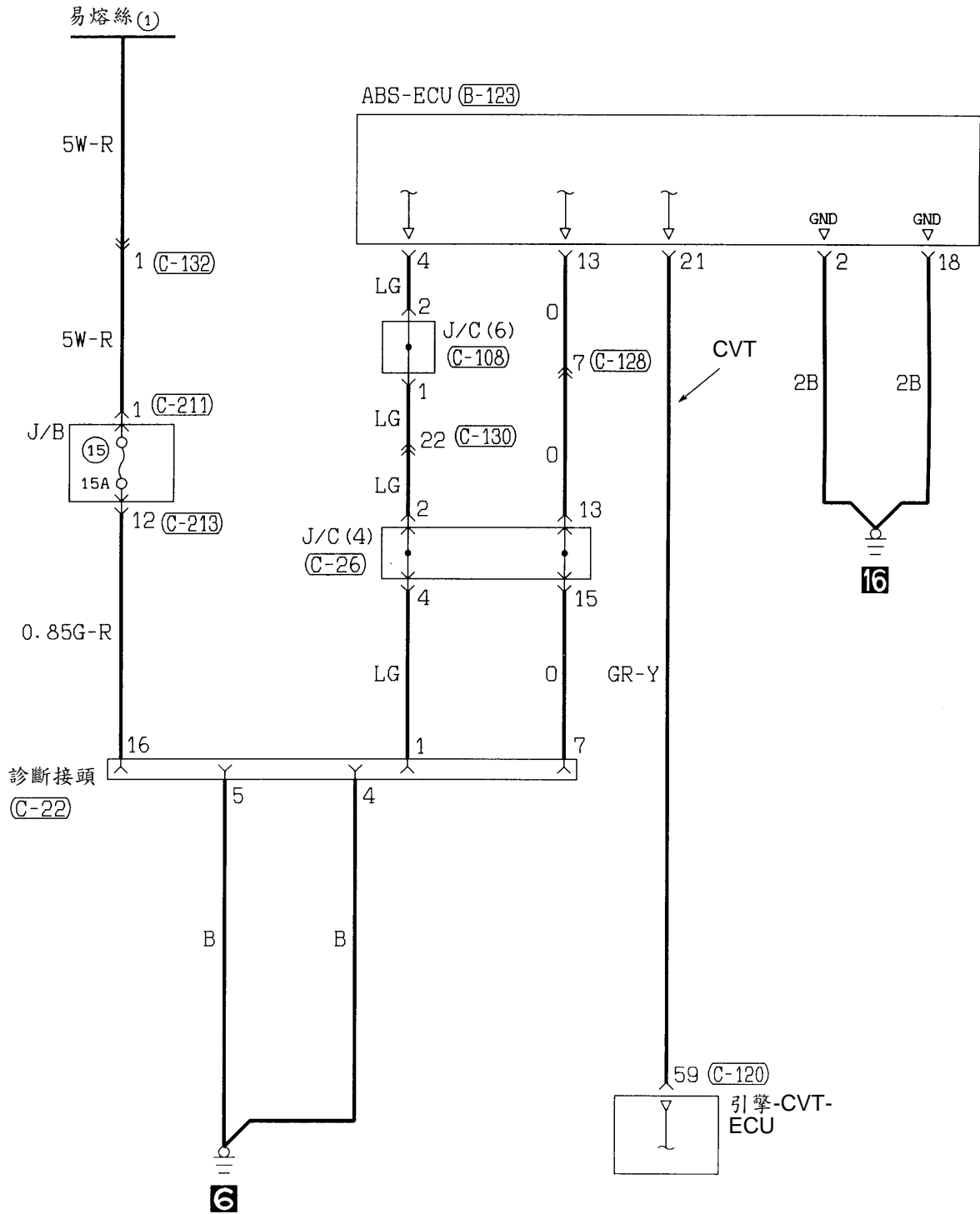

(C-26)

1	2	3	4	5	6	7	8	9	10	11
12	13	14	15	16	17	18	19	20	21	22

(C-108)

1	2	3	4	5	6	7	8	9	10	11
12	13	14	15	16	17	18	19	20	21	22
23	24	25	26	27	28	29	30	31	32	33

(C-111)

1	2	3	4	5	6	7	8	9	10	11	12	13
14	15	16	17	18	19	20	21	22	23	24	25	

(C-120) (MU803781)

41	42	43		44	45	46
47	48	49	50	51	52	53
54	55	56	57	58	59	60
61	62	63	64	65	66	

(C-128)

1	2	3	4	5	6	7	8	9	10	11
12	13	14	15	16	17	18	19	20	21	22

(D-11)

MU801839

1	2	3
4	5	6
7	8	

SRS

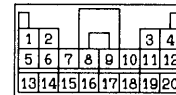
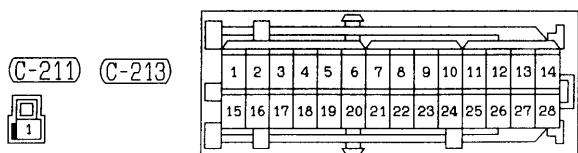
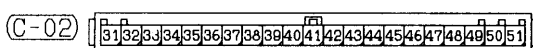
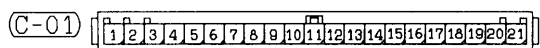
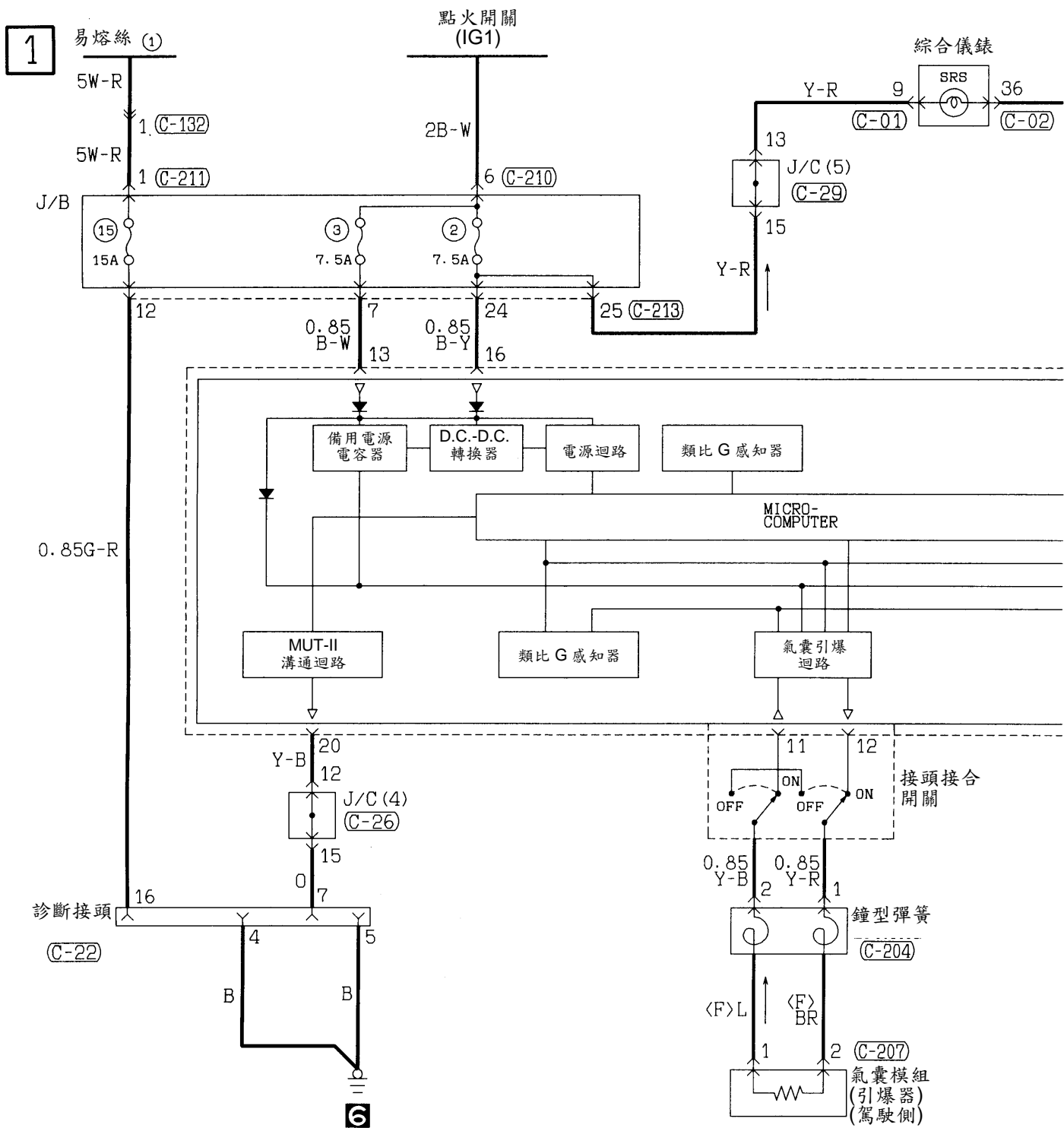

SRS(續)

2

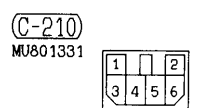
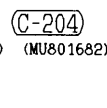
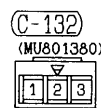
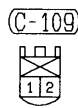
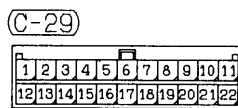
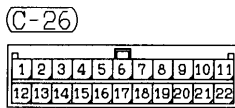
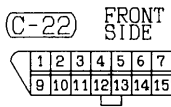
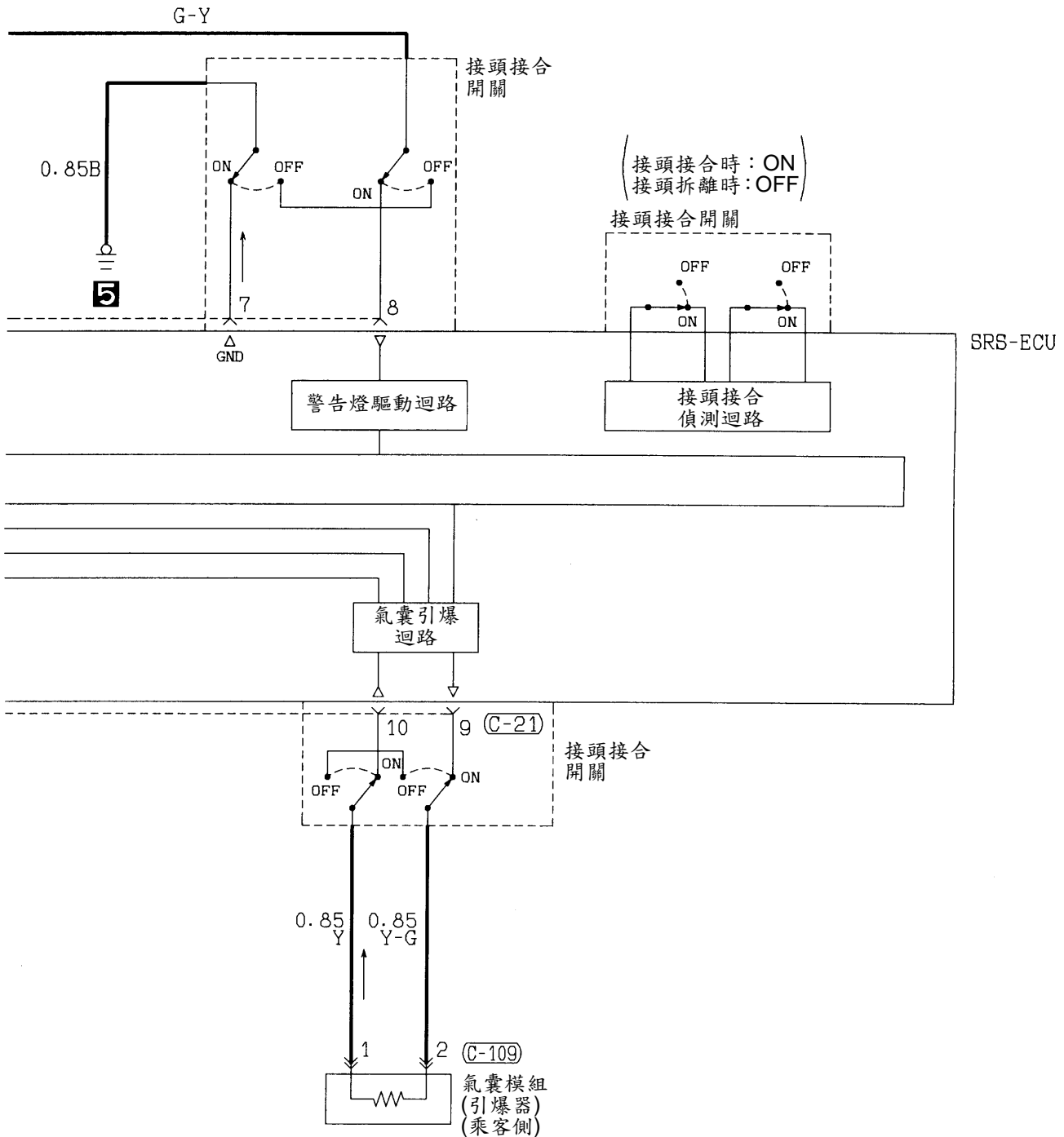

天窗

1

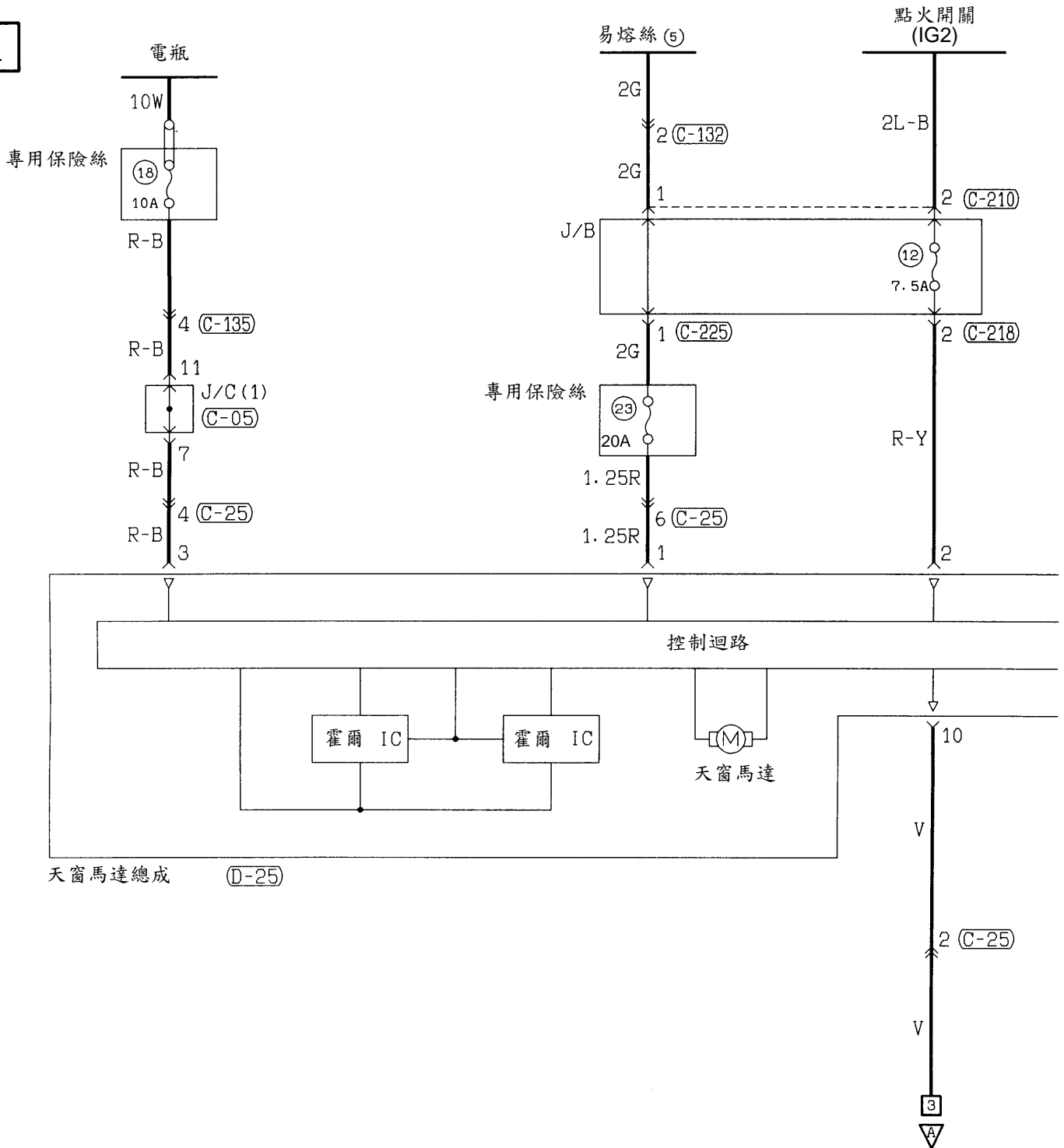

(C-05)

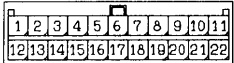

(C-25)

MU801697



(C-132)

(MU801380)



(C-135)

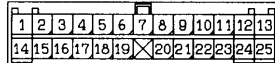

(C-210)

MU801331



(C-218)

MU801685



(C-225)

MU801325



(C-24)

(MU801581)

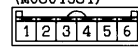

天窗(續)

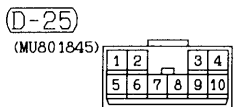
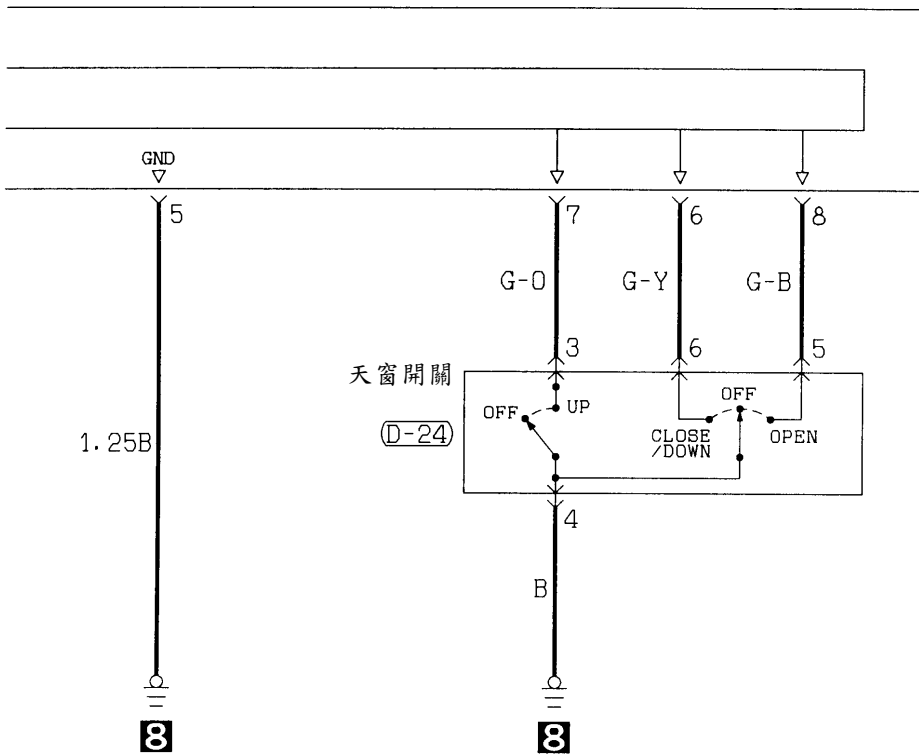

天窗(續)

3

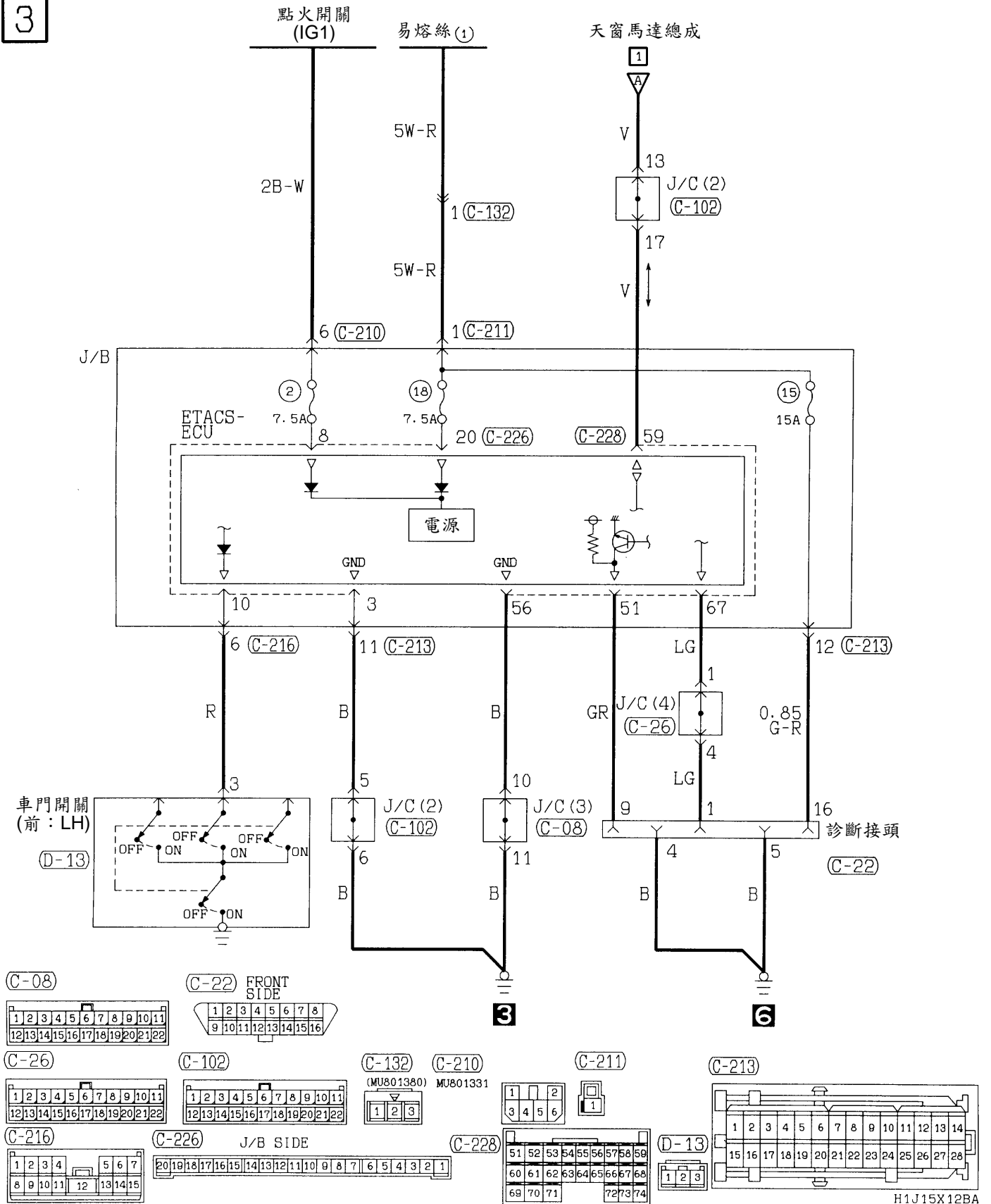

鑰匙未取出蜂鳴器

1

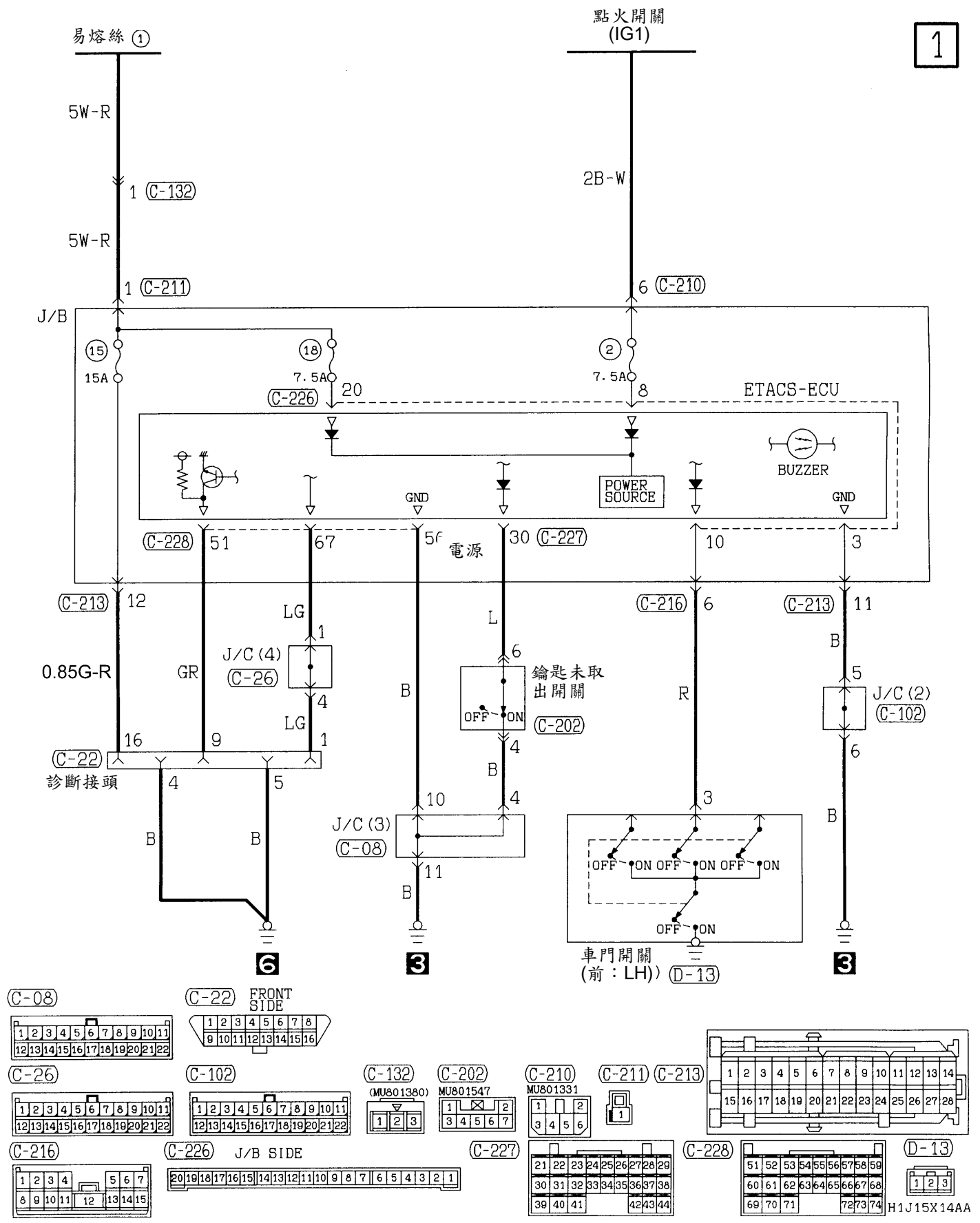

燈光調整器

1

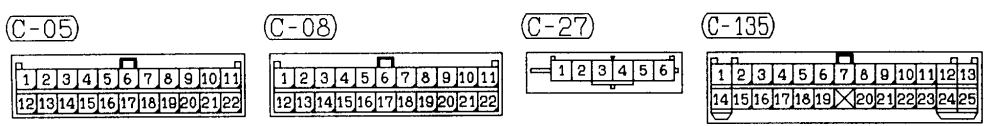
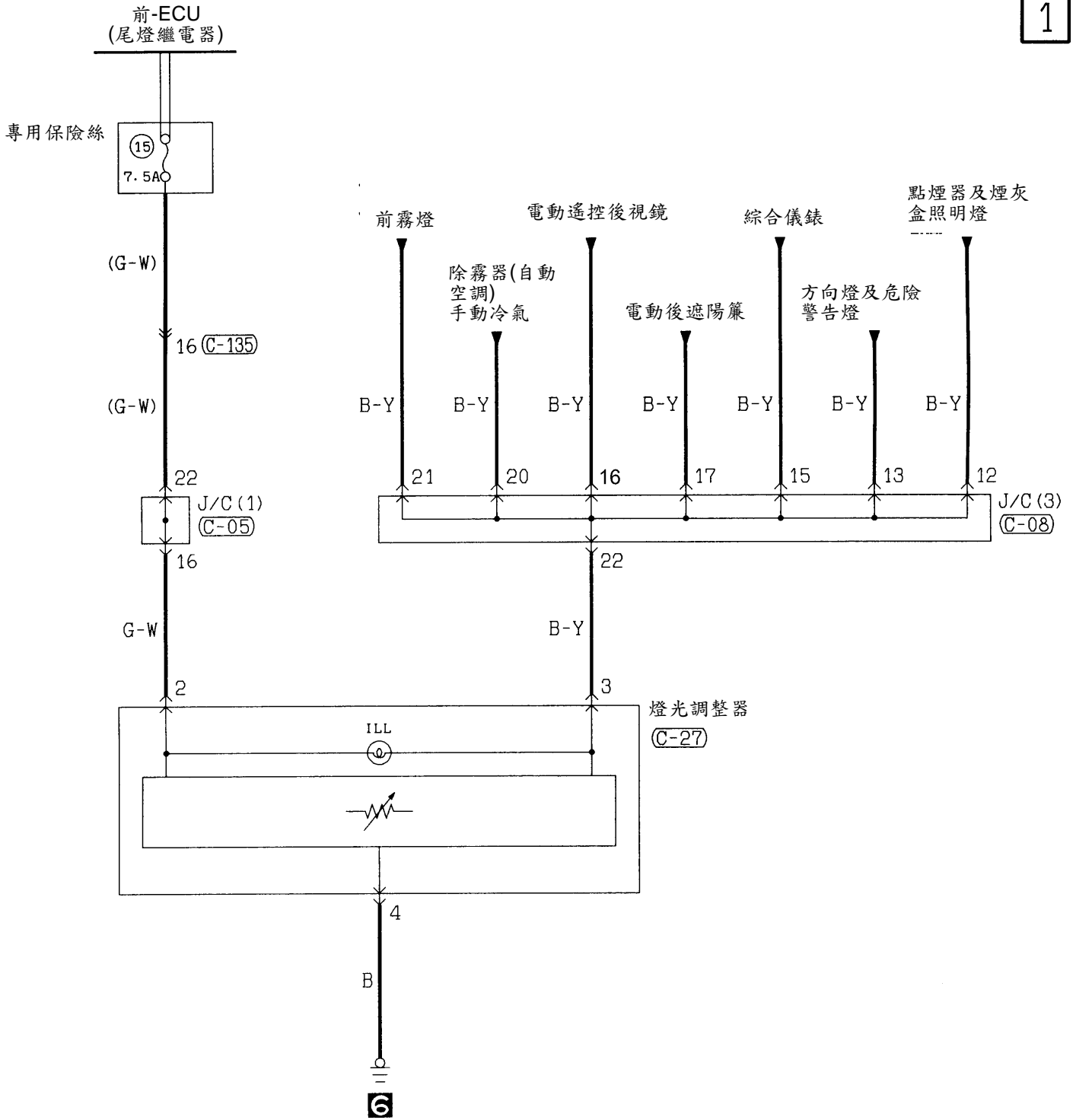

電動座椅(駕駛座)

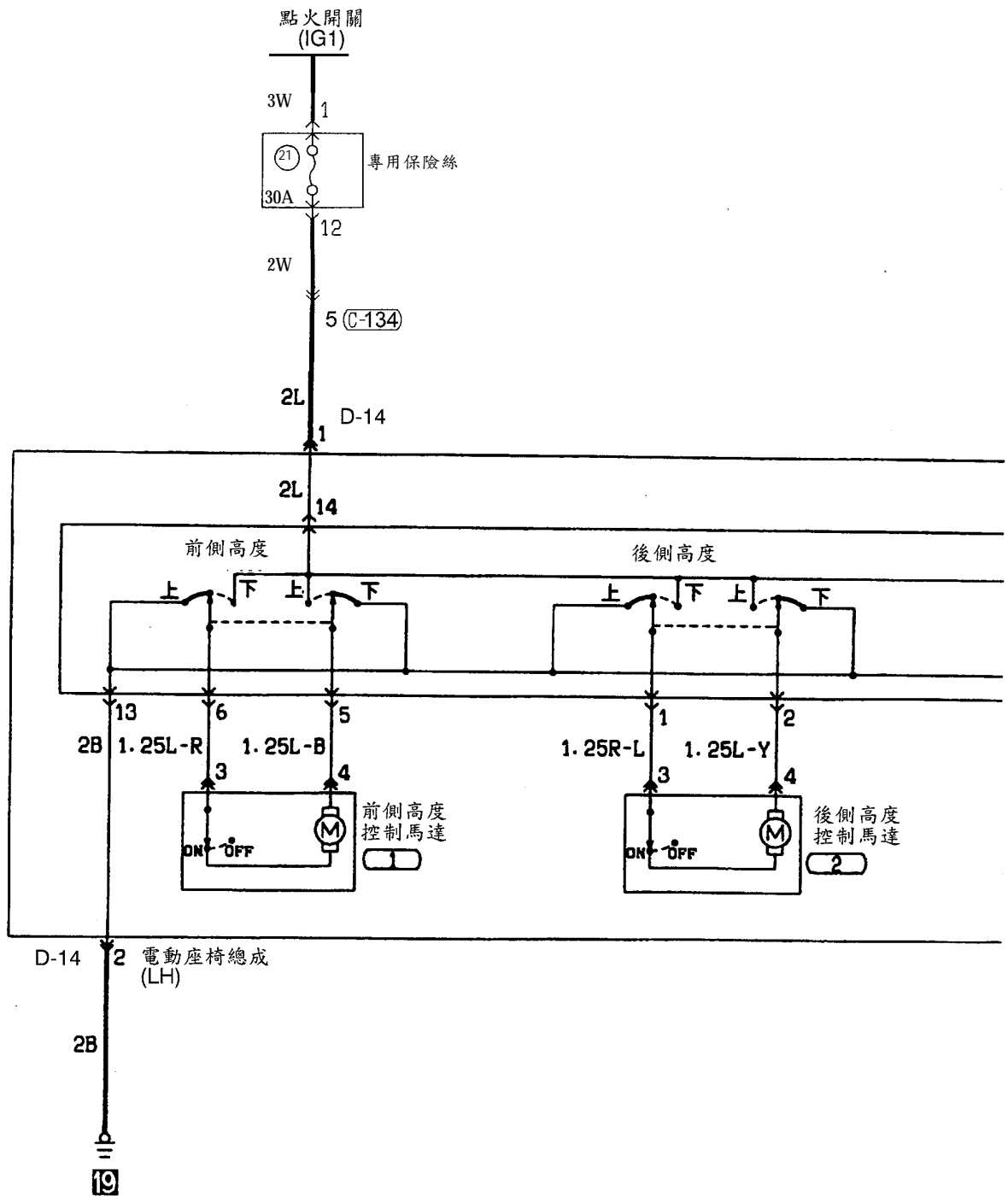

電動座椅(續)

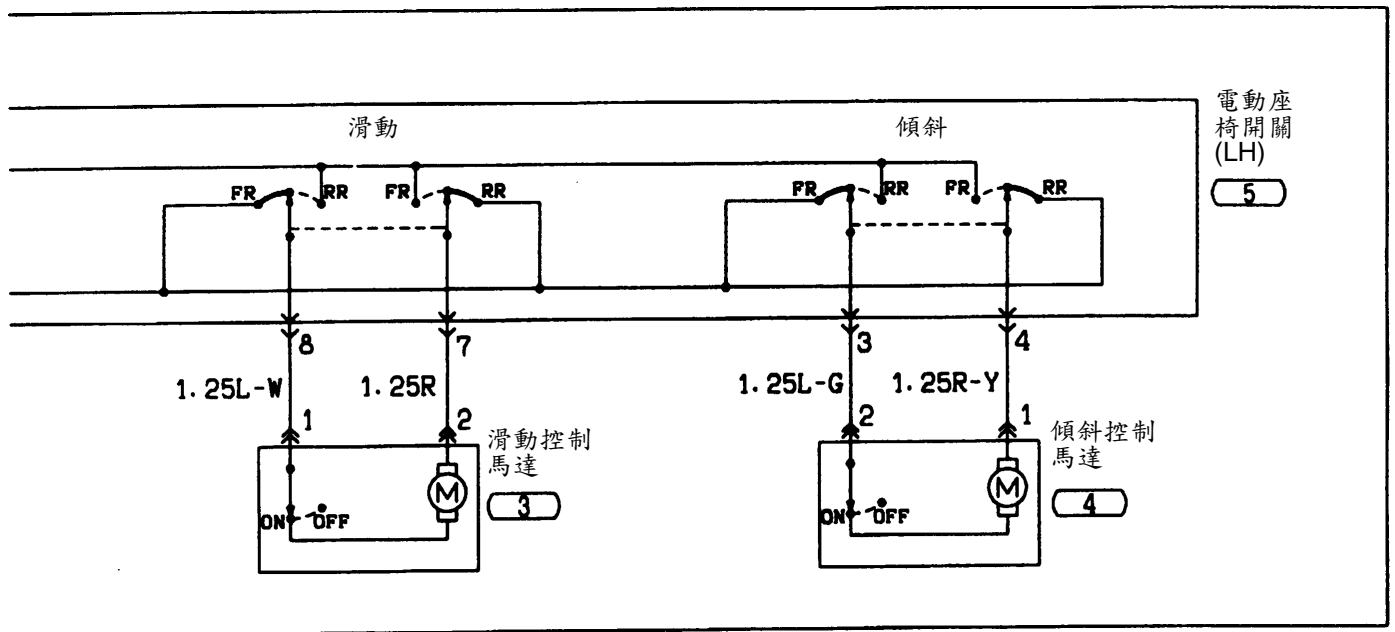

電動護腰器

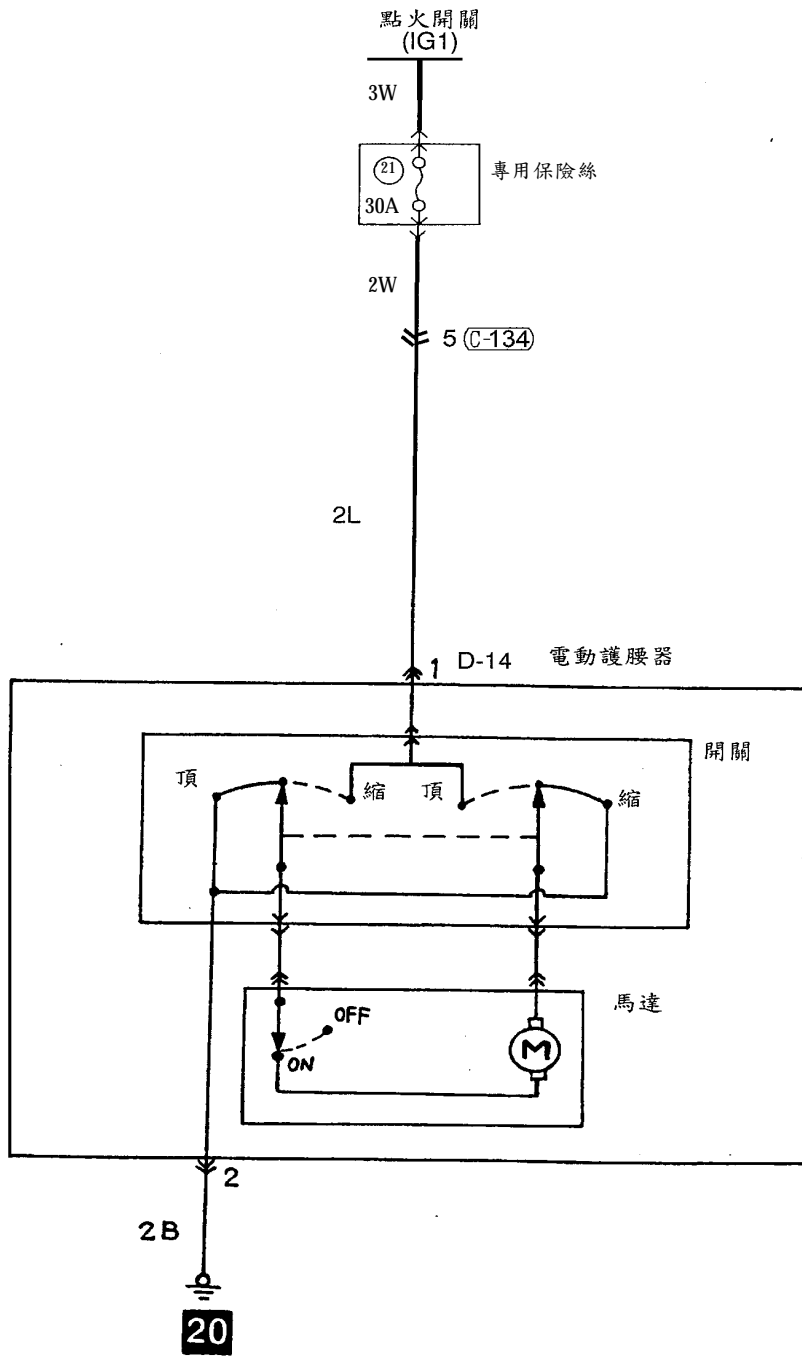

C-114



C-118



遙控防盜

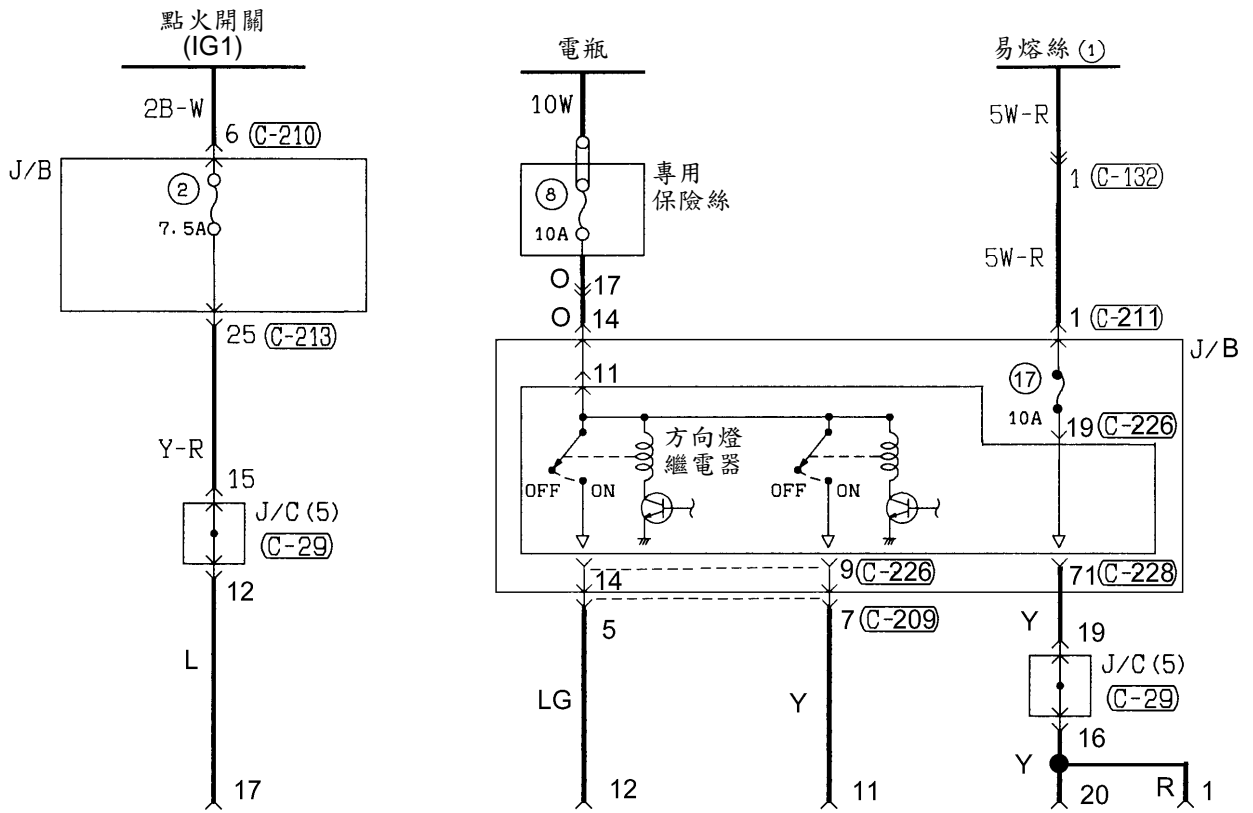

C-18

遙控防盜 ECU

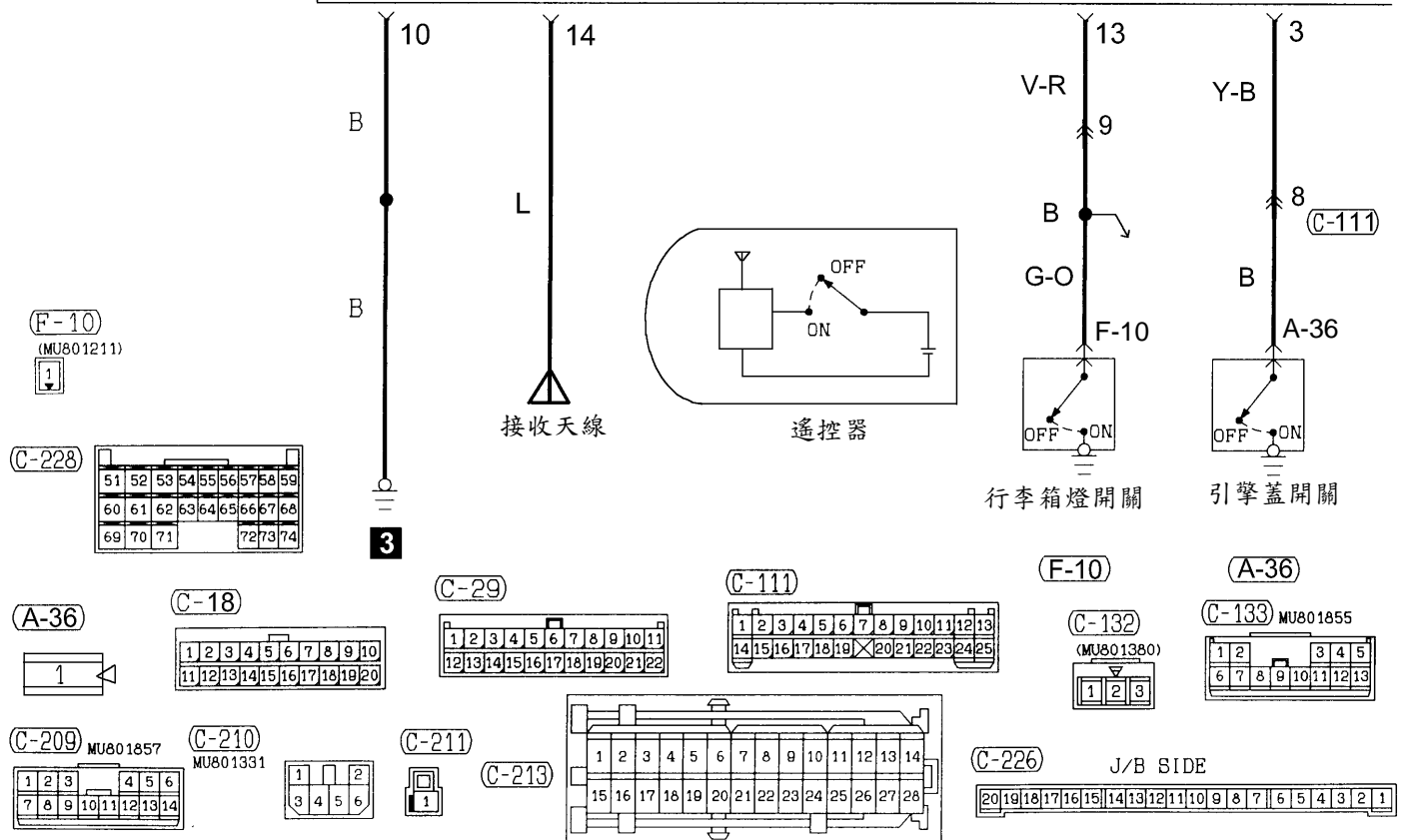

遙控防盜(續)

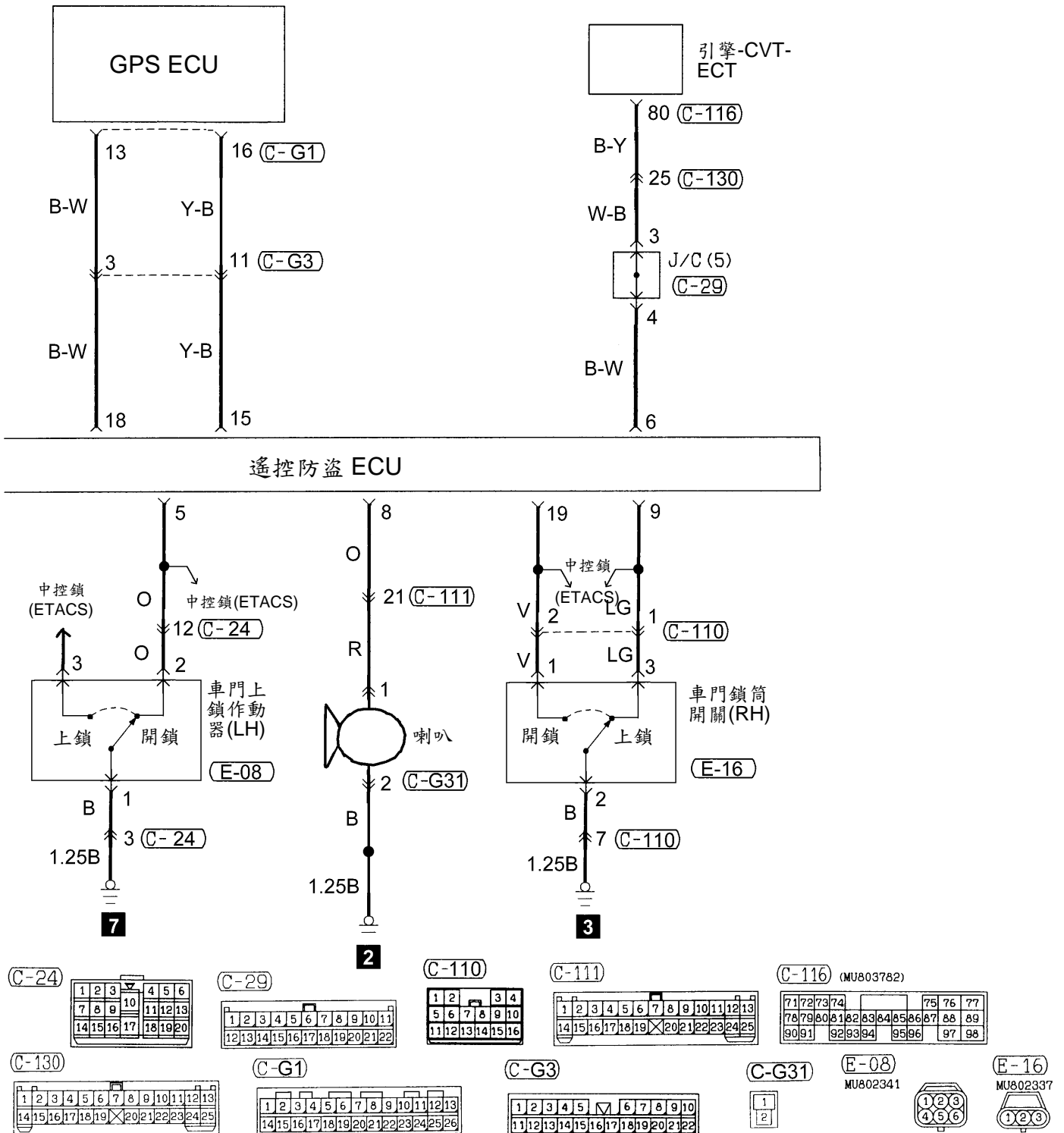

電動後遮陽簾

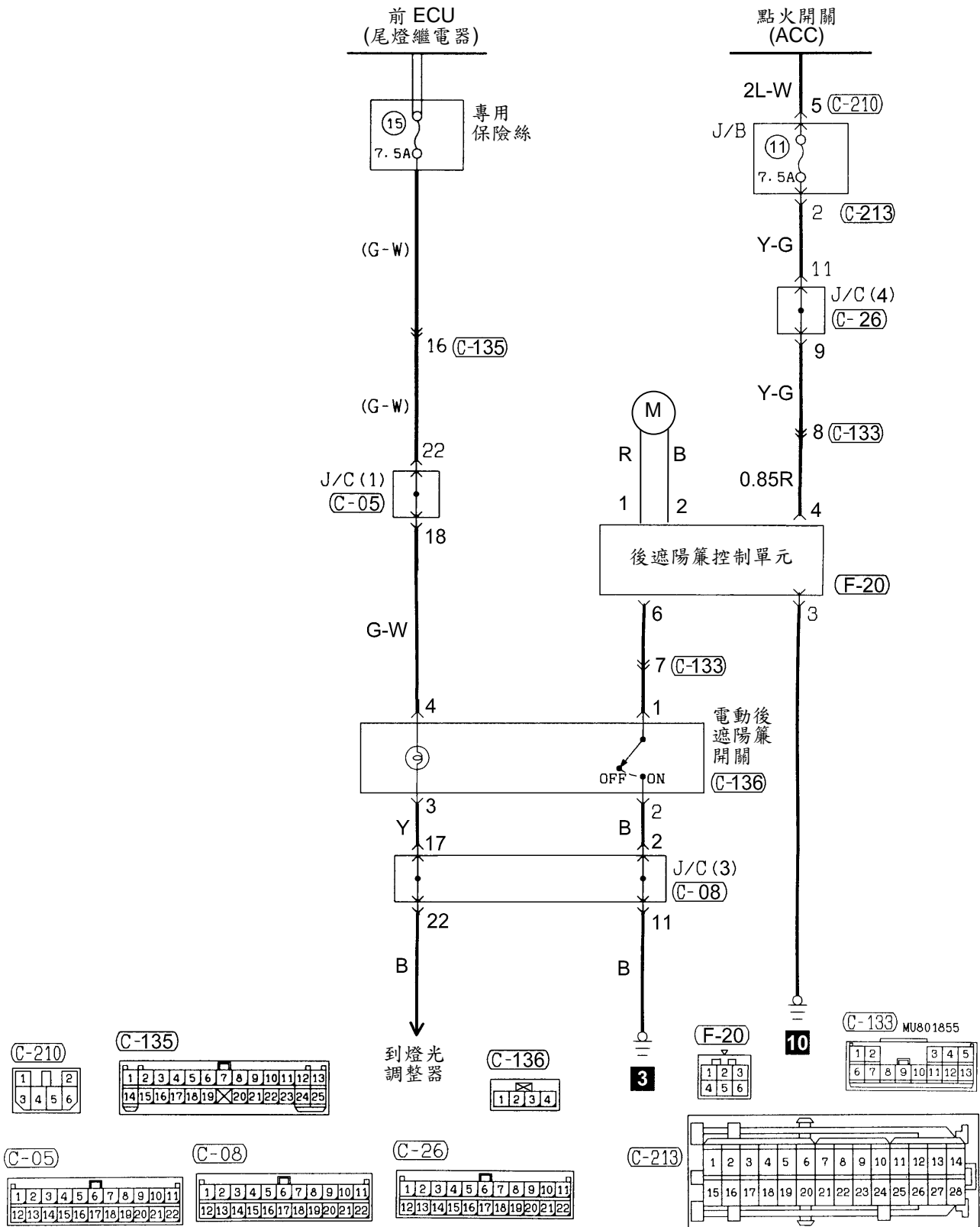

角燈

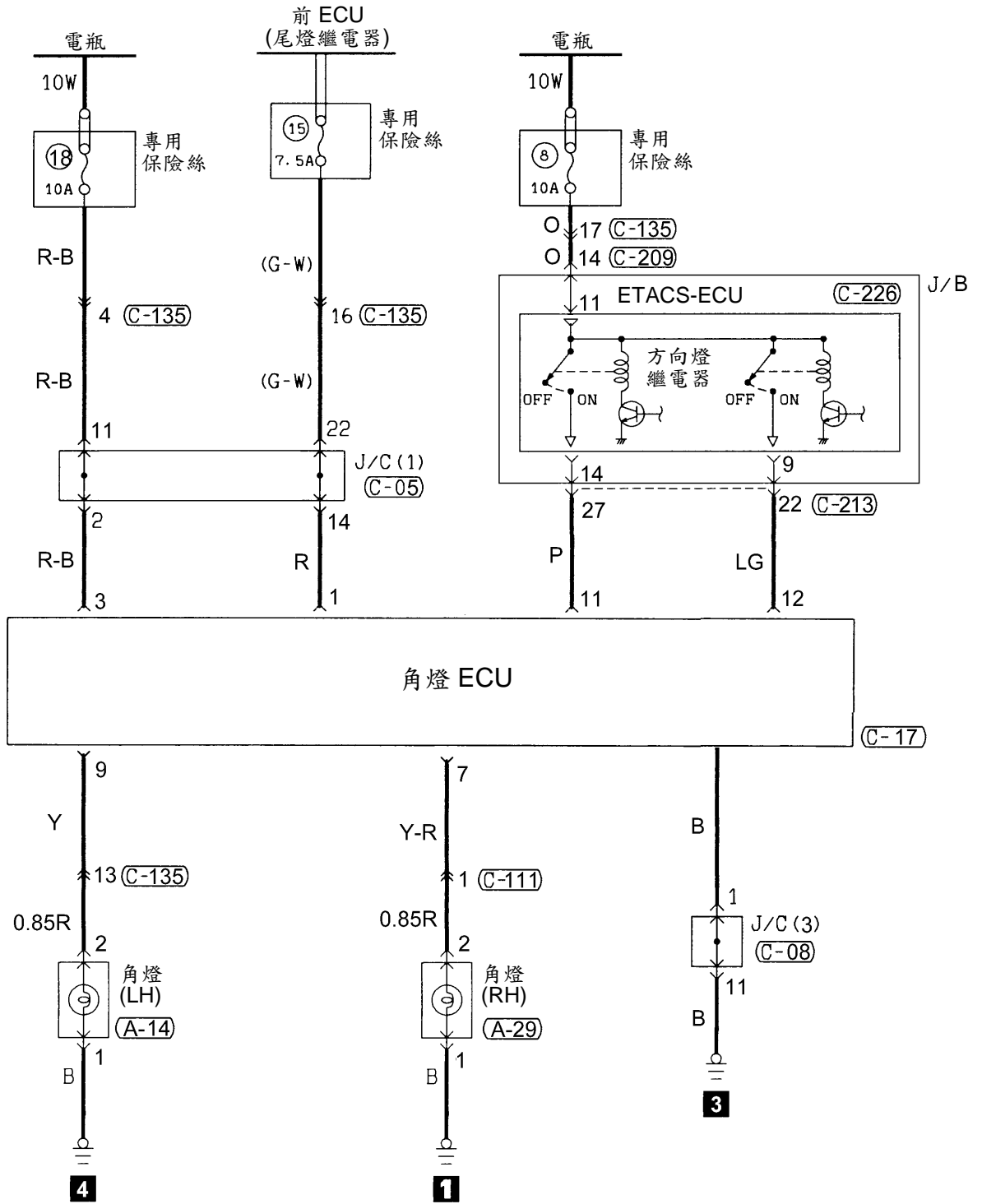

(A-14) (A-29)



(C-05)

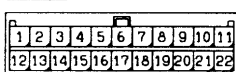

(C-08)

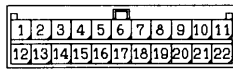

(C-17)

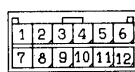

(C-226)

J/B SIDE

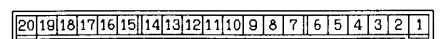

(C-135)

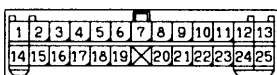

(C-209) MU801857

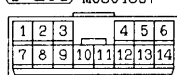

(C-111)

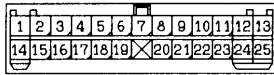

(C-213)

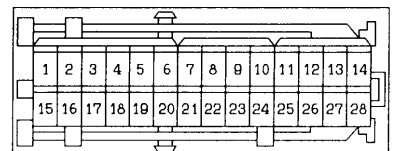

倒車雷達

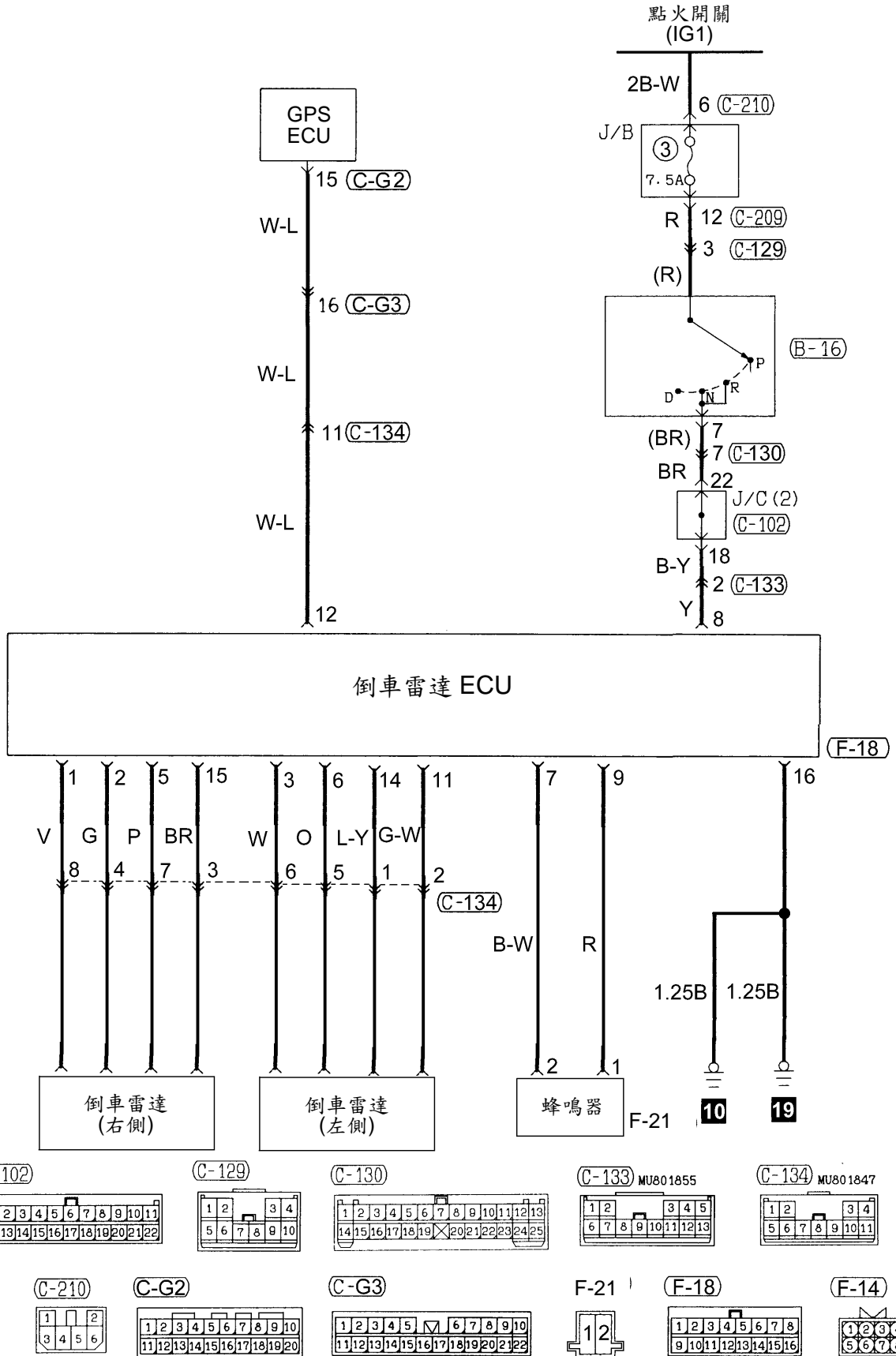

免持聽筒行動電話系統

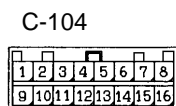
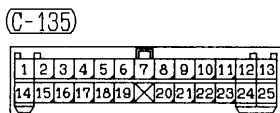
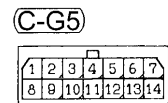
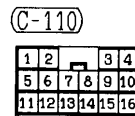
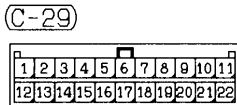
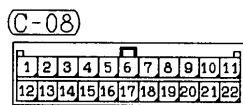
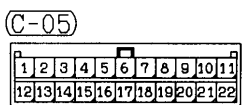
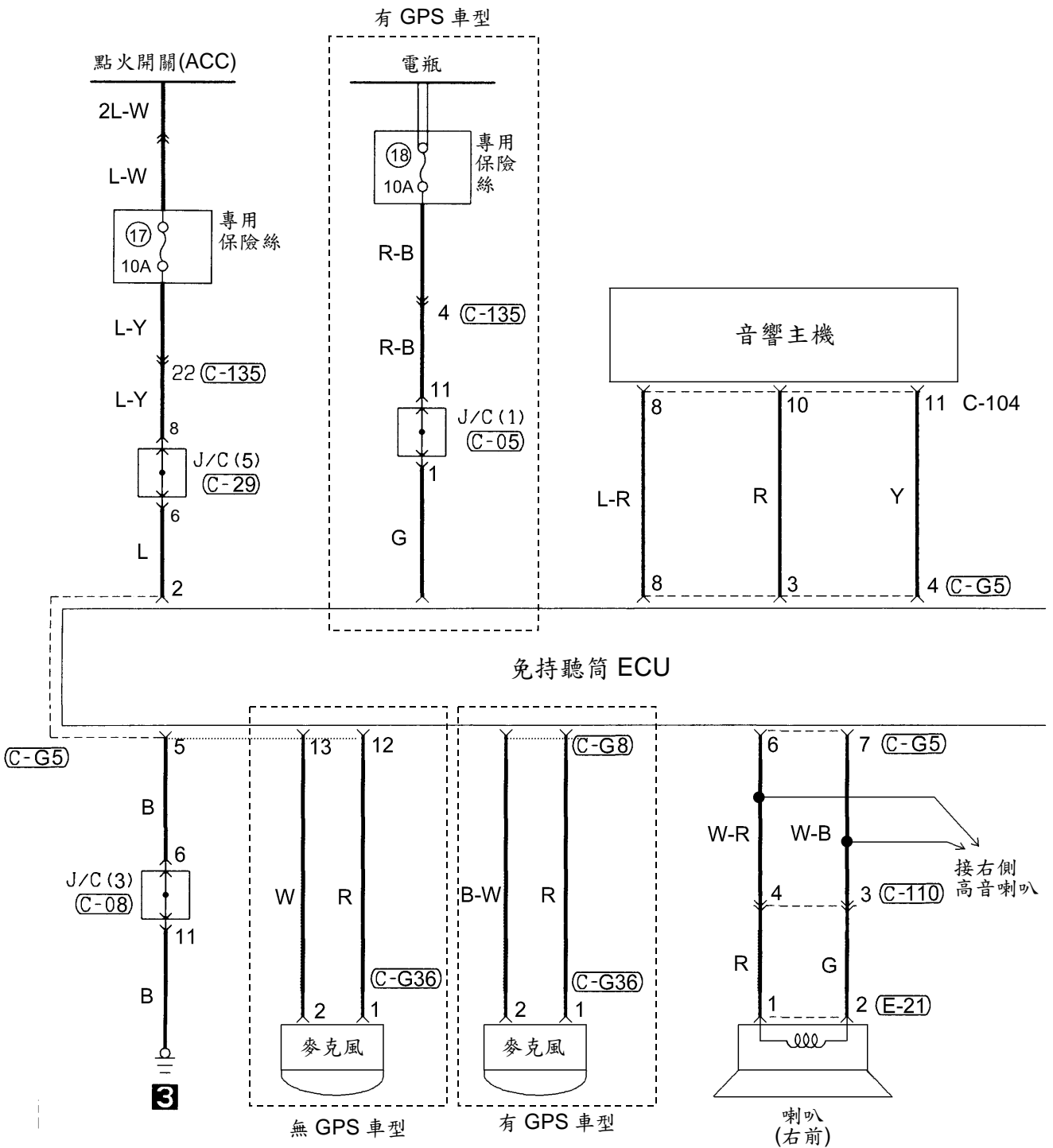

配備 GPS 系統

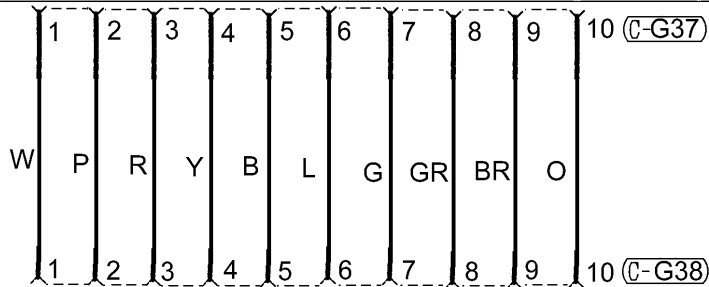
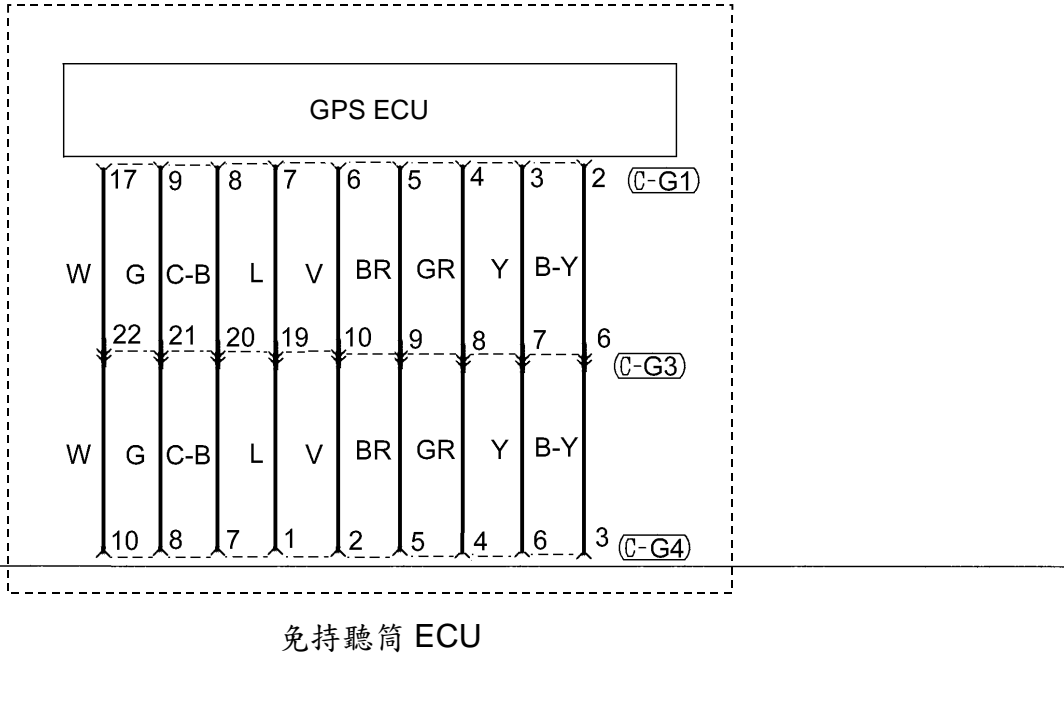

外接行動電話接頭/車裝行動電話(配備 GPS 系統)

(C-G1)

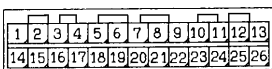

(C-G3)

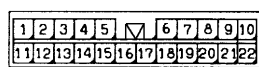

(C-G4)

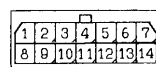

(C-G37)

(C-G38)

