

DTC	P0705	Transmission Range Sensor Circuit Malfunction (PRNDL Input)
------------	--------------	--

DESCRIPTION

The Park/Neutral Position (PNP) switch detects the shift lever position and sends signals to the ECM.

DTC No.	DTC Detection Condition	Trouble Area
P0705	<p>When one of following conditions is met:</p> <p>(A) Any 2 or more of the following signals are ON simultaneously (2 trip detection logic)</p> <ul style="list-style-type: none"> • P input signal is ON • N input signal is ON • R input signal is ON • D input signal is ON • 2 input signal is ON • L input signal is ON <p>(B) Any 2 or more of the following signals are ON simultaneously (2 trip detection logic)</p> <ul style="list-style-type: none"> • NSW input signal is ON • R input signal is ON • D input signal is ON • 2 input signal is ON • L input signal is ON <p>(C) All of the signals are OFF simultaneously (2 trip detection logic)</p> <ul style="list-style-type: none"> • P input signal is OFF • N input signal is OFF • NSW input signal is OFF • R input signal is OFF • D input signal is OFF • 2 input signal is OFF • L input signal is OFF <p>(D) Both 1 and 2 are met (2 trip detection logic)</p> <p>1. Either of the following is met</p> <p>(a) NSW input signal is ON</p> <p>(b) P input signal is ON</p> <p>(c) N input signal is ON</p> <p>(d) R input signal is ON</p> <p>2. Either of the following is met</p> <p>(a) 3 input signal is ON</p> <p>(b) L input signal is ON</p>	<ul style="list-style-type: none"> • Open or short in park/neutral position switch circuit • Park/Neutral position switch • ECM

MONITOR DESCRIPTION

These DTCs indicate a problem with the park/neutral position switch and the wire harness in the park/neutral position switch circuit.

The park/neutral position switch detects the shift lever position and sends a signal to the ECM.

For security, the park/neutral position switch detects the shift lever position so that the engine can be started only when the shift lever is on P or N.

The park/neutral position switch sends a signal to the ECM according to the shift lever position (R, D, 3, 2 or L).

The ECM determines that there is a problem with the switch or related parts if it receives more than 1 position signal simultaneously. The ECM will illuminate the MIL and store the DTC.

MONITOR STRATEGY

Related DTCs	P0705: Park/Neutral position switch/Verify switch input
Required sensors/Components	Park/Neutral position switch
Frequency of operation	Continuous
Duration	2 seconds or 60 seconds
MIL operation	2 driving cycles

Sequence of operation	None
-----------------------	------

TYPICAL ENABLING CONDITIONS

The monitor will run whenever this DTC is not present.	None
Ignition switch	ON
Battery voltage	10.5 V or more

TYPICAL MALFUNCTION THRESHOLDS

Condition (A)

Number of the following signal input at the same time	2 or more
P switch	ON
N switch	ON
R switch	ON
D switch	ON
2 switch	ON
L switch	ON

Condition (B)

Number of the following signal input at the same time	2 or more
NSW switch	ON
R switch	ON
D switch	ON
2 switch	ON
L switch	ON

Condition (C)

When all of the following conditions are met	-
P switch	OFF
N switch	OFF
NSW switch	OFF
R switch	OFF
D switch	OFF
2 switch	OFF
L switch	OFF

Condition (D)

When both conditions (a) and (b) are met	-
(a) When one of following condition is met	-
NSW switch	ON
P switch	ON
N switch	ON
R switch	ON
(b) When one of following condition is met	-
3 switch	ON
L switch	ON

COMPONENT OPERATING RANGE

Park/Neutral position switch	Park/Neutral position switch sends only one signal to ECM.
------------------------------	--

WIRING DIAGRAM

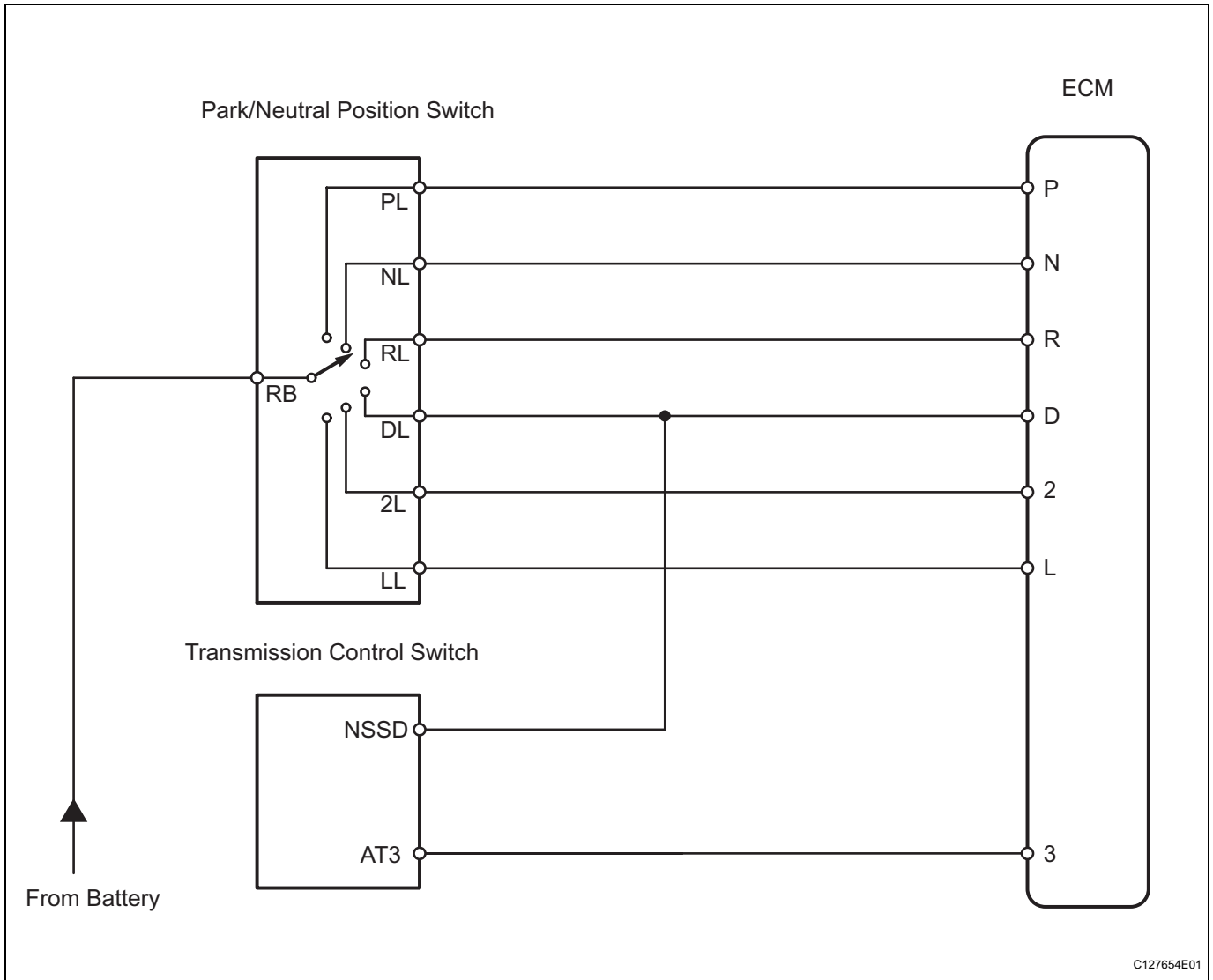

INSPECTION PROCEDURE

HINT:

Using the intelligent tester's DATA LIST allows switch, sensor, actuator and other item values to be read without removing any parts. Reading the DATA LIST early in troubleshooting is one way to save time.

NOTICE:

In the table below, the values listed under "Normal Condition" are reference values. Do not depend solely on these reference values when deciding whether a part is faulty or not.

1. Warm up the engine.
2. Turn the ignition switch OFF.
3. Connect the intelligent tester to the CAN VIM. Then connect the CAN VIM to the DLC3.
4. Turn the ignition switch ON and turn the tester ON.
5. Enter the following menus: DIAGNOSIS / ENHANCED OBD II / DATA LIST.
6. Follow the instructions on the tester and read the DATA LIST.

Item	Measurement Item/ Range (Display)	Normal Condition	Diagnostic Note
PNP SW (NSW)	PNP switch status/ ON or OFF	Shift lever is: On P or N: ON Not on P or N: OFF	When shift lever position displayed on intelligent tester differs from actual position, adjustment of PNP switch or shift cable may be incorrect

Item	Measurement Item/ Range (Display)	Normal Condition	Diagnostic Note
REVERSE	PNP switch status/ ON or OFF	Shift lever is: On R: ON Not on R: OFF	When shift lever position displayed on intelligent tester differs from actual position, adjustment of PNP switch or shift cable may be incorrect
PARKING	PNP switch status/ ON or OFF	Shift lever is: On P: ON Not on P: OFF	When shift lever position displayed on intelligent tester differs from actual position, adjustment of PNP switch or shift cable may be incorrect
NEUTRAL	PNP switch status/ ON or OFF	Shift lever is: On N: ON Not on N: OFF	When shift lever position displayed on intelligent tester differs from actual position, adjustment of PNP switch or shift cable may be incorrect
DRIVE	PNP switch status/ ON or OFF	Shift lever is: On D: ON Not on D: OFF	When shift lever position displayed on intelligent tester differs from actual position, adjustment of PNP switch or shift cable may be incorrect
3RD	PNP switch status/ ON or OFF	Shift lever is: On 3: ON Not on 3: OFF	When shift lever position displayed on intelligent tester differs from actual position, adjustment of PNP switch or shift cable may be incorrect
2ND	PNP switch status/ ON or OFF	Shift lever is: On 2: ON Not on 2: OFF	When shift lever position displayed on intelligent tester differs from actual position, adjustment of PNP switch or shift cable may be incorrect
LOW	PNP switch status/ ON or OFF	Shift lever is: On L: ON Not on L: OFF	When shift lever position displayed on intelligent tester differs from actual position, adjustment of PNP switch or shift cable may be incorrect

1 CHECK WIRE HARNESS (PARK/NEUTRAL POSITION SWITCH - BATTERY)

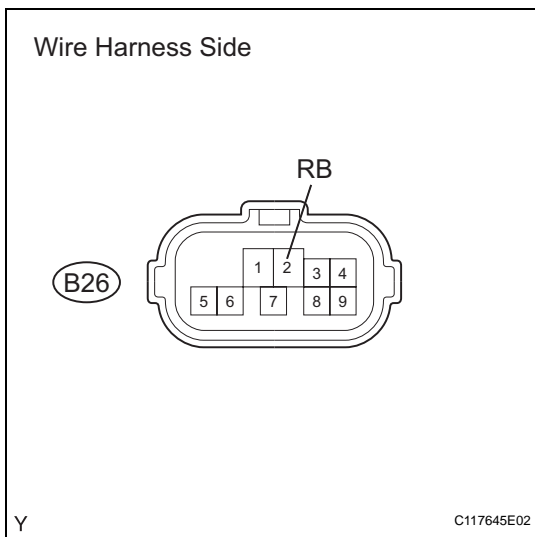

- (a) Disconnect the B26 park/neutral position switch connector.
- (b) Turn the ignition switch ON.
- (c) Measure the voltage.

Standard voltage

Tester Connection	Specified Condition
2 (RB) - Body ground	10 to 14 V

NG **CHECK POWER SOURCE OF ECM**

OK

2 INSPECT PARK/NEUTRAL POSITION SWITCH

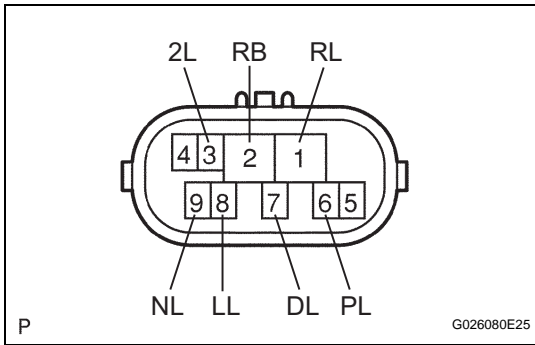

- (a) Disconnect the B26 park/neutral position switch connector.
- (b) Measure the resistance of the park/neutral position switch when the shift lever is moved to each position.

Standard resistance

Tester Connection	Shift Lever Position	Specified Condition
6 (PL) - 2 (RB)	P	Below 1 Ω
6 (PL) - 2 (RB)	Not on P	10 kΩ or higher
1 (RL) - 2 (RB)	R	Below 1 Ω
1 (RL) - 2 (RB)	Not on R	10 kΩ or higher
9 (NL) - 2 (RB)	N	Below 1 Ω
9 (NL) - 2 (RB)	Not on N	10 kΩ or higher
7 (DL) - 2 (RB)	D	Below 1 Ω
7 (DL) - 2 (RB)	Not on D	10 kΩ or higher
3 (2L) - 2 (RB)	2	Below 1 Ω
3 (2L) - 2 (RB)	Not on 2	10 kΩ or higher
8 (LL) - 2 (RB)	L	Below 1 Ω
8 (LL) - 2 (RB)	Not on L	10 kΩ or higher

NG → **REPLACE PARK/NEUTRAL POSITION SWITCH**

OK

3 CHECK WIRE HARNESS (ECM - BATTERY AND BODY GROUND)

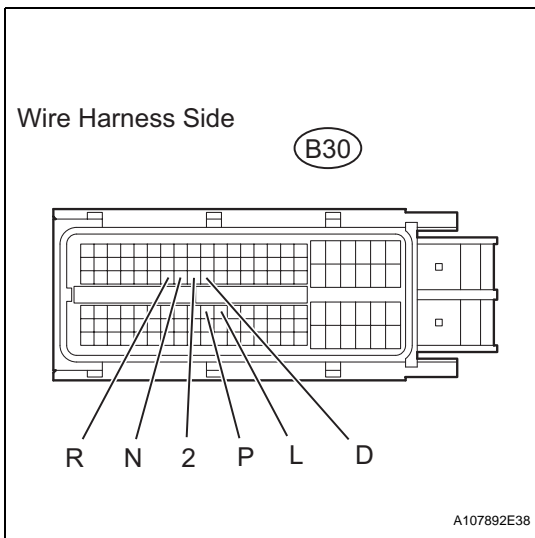

- (a) Disconnect the B30 ECM connector.
- (b) Turn the ignition switch ON.
- (c) Measure the voltage of the wire harness side connector.

Standard voltage

Tester Connection	Shift Lever Position	Specified Condition
B30-73 (P) - Body ground	P	10 to 14 V
B30-73 (P) - Body ground	Not on P	Below 1 V
B30-53 (R) - Body ground	R	10 to 14 V*
B30-53 (R) - Body ground	Not on R	Below 1 V
B30-54 (N) - Body ground	N	10 to 14 V
B30-54 (N) - Body ground	Not on N	Below 1 V
B30-56 (D) - Body ground	D or 3	10 to 14 V
B30-56 (D) - Body ground	Not on D or 3	Below 1 V
B30-55 (2) - Body ground	2	10 to 14 V

Tester Connection	Shift Lever Position	Specified Condition
B30-55 (2) - Body ground	Not on 2	Below 1 V
B30-74 (L) - Body ground	L	10 to 14 V
B30-74 (L) - Body ground	Not on L	Below 1 V

HINT:

*: The voltage will drop slightly due to the illumination of the back-up light.

NG REPAIR OR REPLACE HARNESS AND CONNECTOR

OK

4 CHECK WIRE HARNESS (PARK/NEUTRAL POSITION SWITCH - TRANSMISSION CONTROL SWITCH)

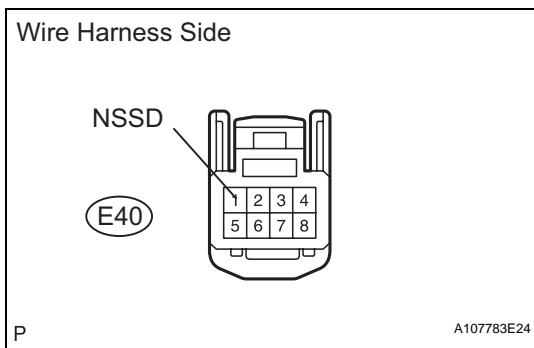

- (a) Disconnect the E40 switch connector.
- (b) Turn the ignition switch ON.
- (c) Measure the voltage when the shift lever is moved to each position.

Standard voltage

Tester Connection	Shift Lever Position	Specified Condition
1 (NSSD) - Body ground	D and 3	10 to 14 V
1 (NSSD) - Body ground	Not on D and 3	Below 1 V

NG REPAIR OR REPLACE HARNESS AND CONNECTOR

OK

5 INSPECT TRANSMISSION CONTROL SWITCH

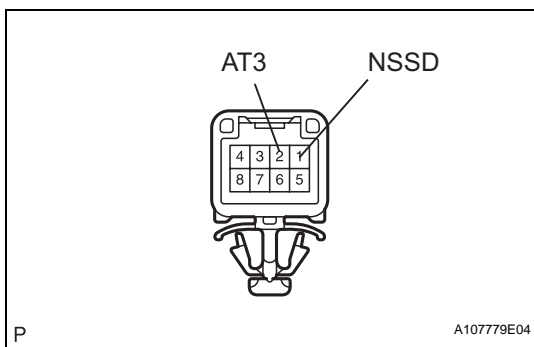

- (a) Disconnect the E40 switch connector.
- (b) Measure the resistance of the switch when the shift lever is moved to each position.

Standard resistance

Tester Connection	Shift Lever Position	Specified Condition
1 (NSSD) - 2 (AT3)	D	10 kΩ or higher
1 (NSSD) - 2 (AT3)	3	Below 1 Ω

NG REPLACE TRANSMISSION CONTROL SWITCH

OK

6 CHECK WIRE HARNESS (TRANSMISSION CONTROL SWITCH - BATTERY AND BODY GROUND)

Wire Harness Side

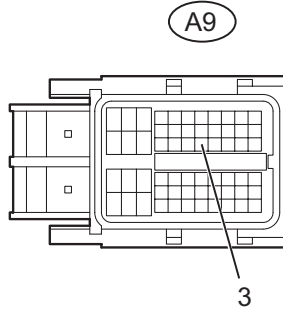

A115671E20

- (a) Disconnect the A9 ECM connector.
- (b) Turn the ignition switch ON.
- (c) Measure the voltage of the wire harness side connector.

Standard voltage

Tester Connection	Shift Lever Position	Specified Condition
A9-26 (3) - Body ground	3	10 to 14 V
A9-26 (3) - Body ground	Not on 3	Below 1 V

HINT:

*: The voltage will drop slightly due to the illumination of the back-up light.

NG

REPAIR OR REPLACE HARNESS AND CONNECTOR

OK

REPLACE ECM