

DTC CHECK/CLEAR

NOTICE:

- If no DTC appears in normal mode:
On the OBD II scan tool or the hand-held tester, check the pending fault code using the Continuous Test Results function (Mode 7 for SAE J1979).
- When the diagnosis system is changed from normal mode to check mode or vice-versa, all DTCs and freeze frame data recorded in normal mode will be erased. Before changing modes, always check and make a note of DTCs and freeze frame data.

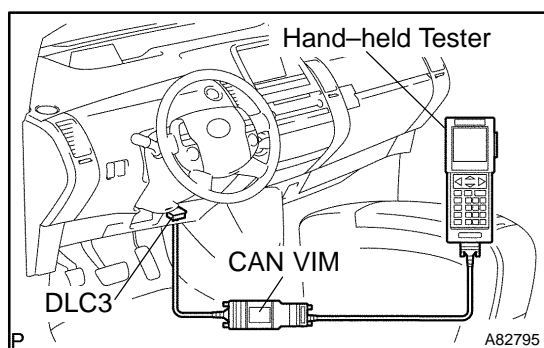

1. CHECK DTC (Using the OBD II scan tool or hand-held tester)

- Connect the OBD II scan tool or hand-held tester to the DLC3.
- Turn the power switch ON (IG).
- Check DTCs and freeze frame data using the scan tool or the tester, and then write them down. For the hand-held tester, enter the following menus: DIAGNOSIS / ENHANCED OBD II / ENGINE AND ECT / DTC INFO / CURRENT CODES.
For the OBD II scan tool, see its instruction manual.
- See page 05-55 to confirm the details of the DTCs.

NOTICE:

- When simulating a symptom with the OBD II scan tool (excluding hand-held tester) to check the DTCs, use normal mode. For DTCs subject to "2 trip detection logic", perform either of the following actions.
- Turn the HV main system OFF (IG OFF) after the symptom is simulated once. Then repeat the simulation process again. When the problem has been simulated again, the MIL illuminates and the DTCs are recorded in the ECM.
- Check the pending fault code using the Continuous Test Results function (Mode 7 for SAE J1979) on the OBD II scan tool.

2. CLEAR DTC

- (a) Connect the OBD II scan tool or the hand-held tester to the DLC3.
- (b) Turn the power switch ON (IG).
- (c) Erase DTCs and freeze frame data using the OBD II scan tool or the hand-held tester.

For the hand-held tester:

- (1) Enter the following menus: DIAGNOSIS / ENHANCED OBD II / ENGINE AND ECT / DTC INFO / CLEAR CODES.

- (2) Press YES.

- (d) For the OBD II scan tool, see its instruction manual.

NOTICE:

Clearing the DTCs will also clear the freeze frame data, detailed information and operation history data.

3. CLEAR DTC (Not using the OBD II scan tool or hand-held tester)

- (a) Remove the EFI and ECTS fuses from the engine room R/B for more than 60 seconds, or disconnecting the battery cable for more than 60 seconds.

NOTICE:

When disconnecting the battery cable, perform the "INITIALIZE" procedure (see page 01-28).

