

<b>DTC</b>	<b>P0171</b>	<b>SYSTEM TOO LEAN (BANK 1)</b>
------------	--------------	---------------------------------

<b>DTC</b>	<b>P0172</b>	<b>SYSTEM TOO RICH (BANK 1)</b>
------------	--------------	---------------------------------

## CIRCUIT DESCRIPTION

The fuel trim is related to the feedback compensation value, not to the basic injection time. The fuel trim includes the short-term fuel trim and the long-term fuel trim.

The short-term fuel trim is the short-term fuel compensation used to maintain the air-fuel ratio at stoichiometric air-fuel ratio. The signal from the A/F sensor indicates whether the air-fuel ratio is RICH or LEAN compared to the stoichiometric air-fuel ratio. This variance triggers a reduction in the fuel volume if the air-fuel ratio is RICH, and an increase in the fuel volume if it is LEAN.

The long-term fuel trim is the overall fuel compensation carried out in long-term to compensate for a continual deviation of the short-term fuel trim from the central value, due to individual engine differences, wear over-time and changes in the operating environment.

If both the short-term fuel trim and the long-term fuel trim are LEAN or RICH beyond a certain value, it is detected as a malfunction and the MIL is illuminated and DTC is set.

DTC No.	DTC Detection Condition	Trouble Area
P0171	When air-fuel ratio feedback is stable after warming up engine, fuel trim is considerably in error on LEAN side (2 trip detection logic)	<ul style="list-style-type: none"> <li>• Air induction system</li> <li>• Injector blockage</li> <li>• Mass air flow meter</li> <li>• Engine coolant temperature sensor</li> <li>• Fuel pressure</li> <li>• Gas leakage in exhaust system</li> <li>• Open or short in A/F sensor (bank 1, sensor 1) circuit</li> <li>• A/F sensor (bank 1, sensor 1)</li> <li>• A/F sensor heater (bank 1, sensor 1)</li> <li>• EFI M relay</li> <li>• PCV valve and hose</li> <li>• PCV hose connection</li> <li>• ECM</li> </ul>
P0172	When air-fuel ratio feedback is stable after warming up engine, fuel trim is considerably in error on RICH side (2 trip detection logic)	<ul style="list-style-type: none"> <li>• Injector leak, blockage</li> <li>• Mass air flow meter</li> <li>• Engine coolant temperature sensor</li> <li>• Ignition system</li> <li>• Fuel pressure</li> <li>• Gas leakage in exhaust system</li> <li>• Open or short in A/F sensor (bank 1, sensor 1) circuit</li> <li>• A/F sensor (bank 1, sensor 1)</li> <li>• A/F sensor heater</li> <li>• EFI M relay</li> <li>• ECM</li> </ul>

### HINT:

- When DTC P0171 is recorded, the actual air-fuel ratio is on the LEAN side. When DTC P0172 is recorded, the actual air-fuel ratio is on the RICH side.
- If the vehicle runs out of fuel, the air-fuel ratio is LEAN and DTC P0171 may be recorded. The MIL then illuminates.
- If the total of the short-term fuel trim value and long-term fuel trim value is between +33 % and -30 % (engine coolant temperature is more than 75°C (167°F)), the system is functioning normally.

## MONITOR DESCRIPTION

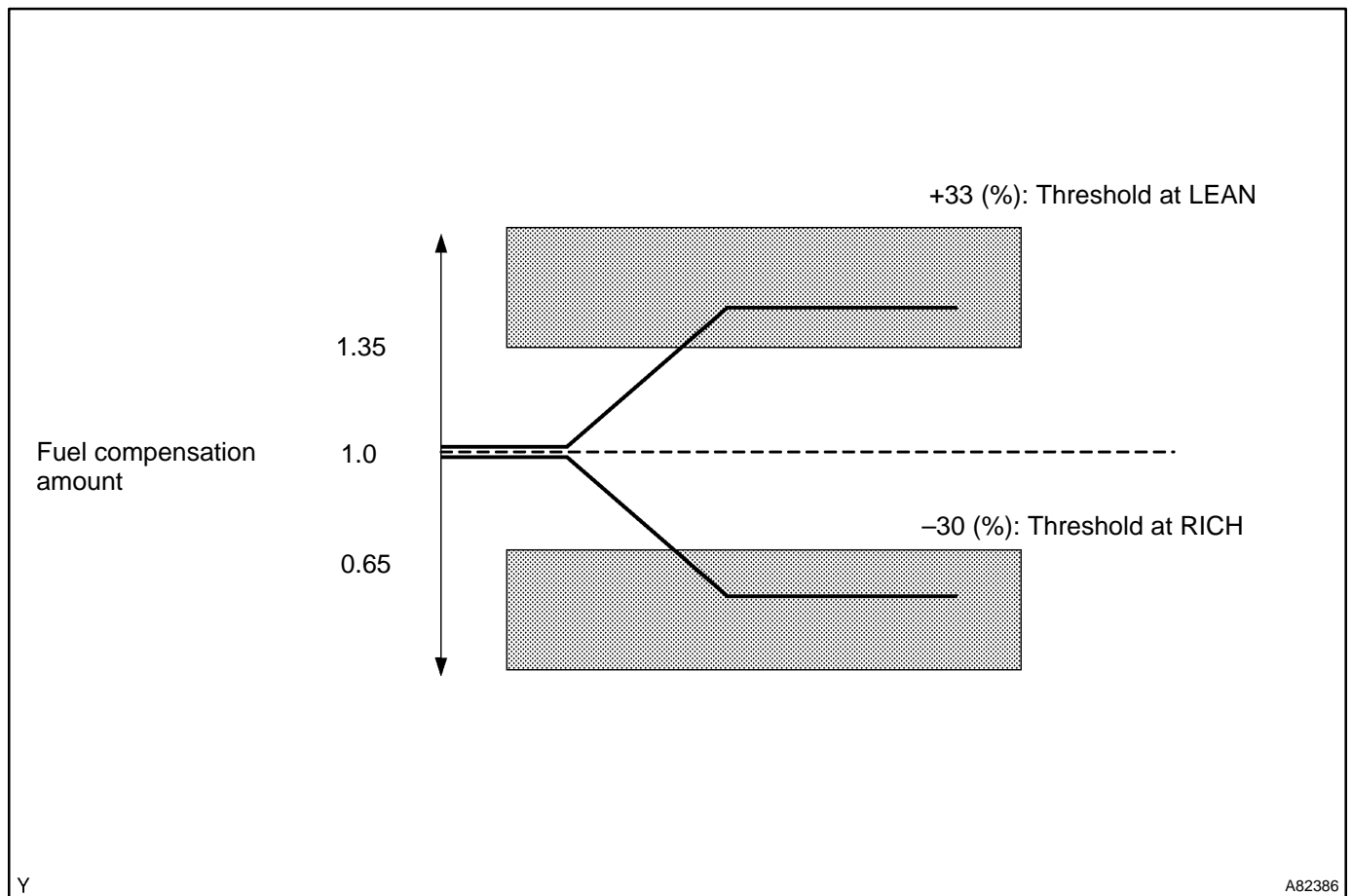

Under closed-loop fuel control, fuel injection amount that deviates from the ECM's estimated fuel amount will cause a change in the long-term fuel trim compensation value. This long-term fuel trim is adjusted when there are persistent deviations in the short-term fuel trim values. And the deviation from the simulated fuel injection amount by the ECM affects a smoothed fuel trim learning value. The smoothed fuel trim learning value is the combination of smoothed short-term fuel trim (fuel feedback compensation value) and smoothed long-term fuel trim (learning value of the air-fuel ratio). When the smoothed fuel trim learning value exceeds the DTC threshold, the ECM interprets this as a fault in the fuel system and sets a DTC.

Example:

The smoothed fuel trim leaning value is more than +33% or less than -30%. The ECM interprets this as a failure in the fuel system.

DTC P0171 indicates that the air-fuel mixture is extremely LEAN, and P0172 indicates extremely RICH.

## MONITOR STRATEGY

Related DTCs	P0171: Fuel system lean (bank 1) P0172: Fuel system rich (bank 1)
Required sensors/components	Main: A/F sensor Related: Engine coolant temperature sensor, mass air flow meter, crankshaft position sensor
Frequency of operation	Continuous
Duration	10 seconds
MIL operation	2 driving cycles
Sequence of operation	None

## TYPICAL ENABLING CONDITIONS

The monitor will run whenever the following DTCs are not present	See page 05-20
Battery voltage	11 V or more
Fuel system: Closed-loop	13 seconds or more
One of the following condition is met:	(a) or (b)
(a) Engine speed	Less than 1,100 rpm
(b) Intake air amount per revolution	0.22 g/rev or more
Warm-up condition enables air-fuel ratio learning control	Conditions are met

## TYPICAL MALFUNCTION THRESHOLDS

Following condition is continued for 3 seconds	(a) or (b)
(a) Smoothed fuel trim learning value (lean)	33 % or more
(b) Smoothed fuel trim learning value (rich)	-30 % or less

## WIRING DIAGRAM

Refer to DTC P2195 on page 05-314.

## INSPECTION PROCEDURE

### HINT:

Malfunctioning areas can be found by performing the ACTIVE TEST / A/F CONTROL operation. The A/F CONTROL operation can determine if the A/F sensor, heated oxygen sensor or other potential trouble area are malfunctioning or not.

(a) Perform the ACTIVE TEST A/F CONTROL operation.

### HINT:

The A/F CONTROL operation lowers the injection volume 12.5% or increases the injection volume 25%.

- (1) Connect the hand-held tester to the DLC3 on the vehicle.
- (2) Turn the power switch ON (IG).
- (3) Put the engine in inspection mode (see page 05-1).
- (4) Warm up the engine by running the engine at 2,500 rpm with the accelerator pedal depressed more than 60 % for approximately 90 seconds.
- (5) Select the item: DIAGNOSIS / ENHANCED OBD II / ENGINE AND ECT / ACTIVE TEST / A/F CONTROL.
- (6) Perform the A/F CONTROL operation with the engine in an idle condition (press the right or left button).

### Result:

**A/F sensor reacts in accordance with increase and decrease of injection volume:**

**+25 % → rich output: Less than 3.0 V**

**-12.5 % → lean output: More than 3.35 V**







**Heated oxygen sensor reacts in accordance with increase and decrease of injection volume:**

**+25 % → rich output: More than 0.55 V**

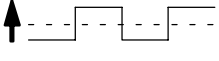
**-12.5 % → lean output: Less than 0.4 V**

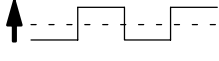
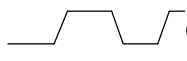
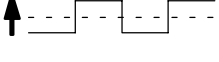
### NOTICE:

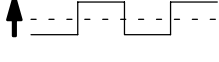
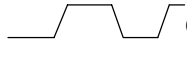
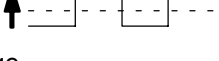
The A/F sensor output has a few seconds of delay and the heated oxygen sensor output has about 20 seconds of delay at maximum.

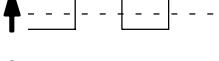
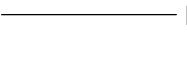
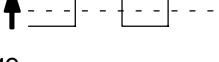
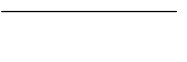
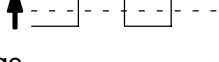
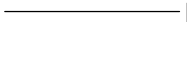
	Output voltage of A/F sensor (sensor 1)	Output voltage of heated oxygen sensor (sensor 2)	Main Suspect Trouble Area
Case 1	Injection volume +25%  -12.5% Output voltage More than 3.35 V  <b>OK</b> Less than 3.0 V	Injection volume +25%  -12.5% Output voltage More than 0.55 V  <b>OK</b> Less than 0.4V	—
Case 2	Injection volume +25%  -12.5% Output voltage Almost no reaction  <b>NG</b>	Injection volume +25%  -12.5% Output voltage More than 0.55 V  <b>OK</b> Less than 0.4V	A/F sensor (A/F sensor, sensor heater, sensor circuit)
Case 3	Injection volume +25%  -12.5% Output voltage More than 3.35 V  <b>OK</b> Less than 3.0V	Injection volume +25%  -12.5% Output voltage Almost no reaction  <b>NG</b>	Heated oxygen sensor (heated oxygen sensor, sensor heater, sensor circuit)
Case 4	Injection volume +25%  -12.5% Output voltage Almost no reaction  <b>NG</b>	Injection volume +25%  -12.5% Output voltage Almost no reaction  <b>NG</b>	Extremely RICH or LEAN actual air-fuel ratio (Injector, fuel pressure, gas leakage in exhaust system, etc.)

The following A/F CONTROL procedure enables the technician to check and graph the voltage output of both A/F sensor and heated oxygen sensor.

To display the graph, enter ACTIVE TEST/ A/F CONTROL/USER DATA, select "AFS B1S1 and O2S B1S2" by pressing the "YES" button followed by the "ENTER" button and then the "F4" button.

**HINT:**

- Read freeze frame data using the hand-held tester or the OBD II scan tool. Freeze frame data records the engine condition when malfunction is detected. When troubleshooting, freeze frame data can help determine if the vehicle was running or stopped, if the engine was warmed up or not, if the air-fuel ratio was lean or rich, and other data from the time the malfunction occurred.
- A high A/F sensor voltage could be caused by a RICH air-fuel mixture. Check the conditions that would cause the engine to run with the RICH air-fuel mixture.
- A low A/F sensor voltage could be caused by a LEAN air-fuel mixture. Check the conditions that would cause the engine to run with the LEAN air-fuel mixture.

**1 CHECK AIR INDUCTION SYSTEM**

- (a) Check for vacuum leaks in the air induction system.

**OK: No vacuum leakage.**

**NG**

**REPAIR OR REPLACE AIR INDUCTION SYSTEM**

**OK**

**2 CHECK CONNECTION OF PCV HOSE**

**OK: PCV hose is connected correctly and PCV hose is not damaged.**

**NG**

**REPAIR OR REPLACE PCV HOSE**

**OK**

**3 INSPECT FUEL INJECTOR ASSY(INJECTION AND VOLUME) (See page 11-9)**

**OK:**

**Injection volume: 36 to 46 cm<sup>3</sup> (2.1 to 2.8 cu in.) per 15 seconds.**

**NG**

**REPLACE FUEL INJECTOR ASSY  
(See page 11-12)**

**OK**

**4 INSPECT MASS AIR FLOW METER**

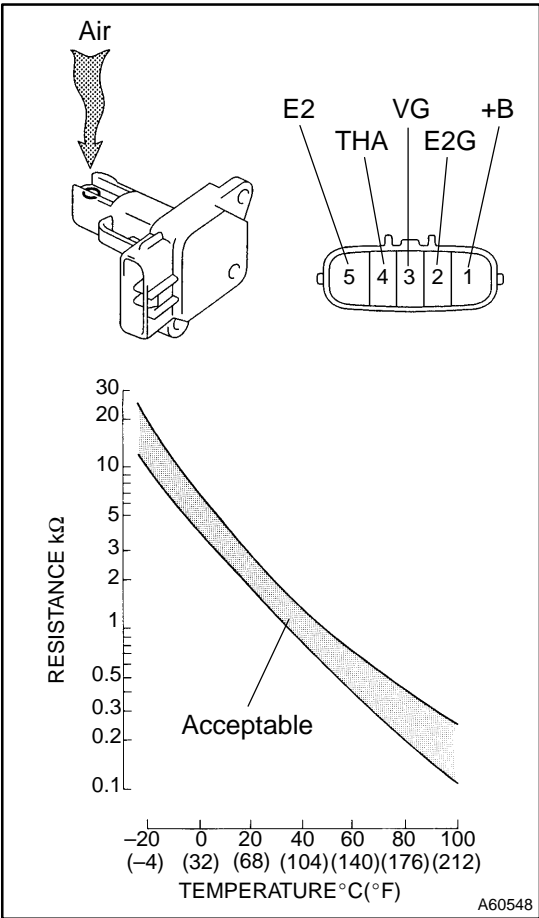

- (a) Remove the mass air flow meter.
- (b) Inspect output voltage.
  - (1) Apply battery voltage across terminals +B and E2G.
  - (2) Connect the positive (+) tester probe to terminal VG, and negative (-) tester probe to terminal E2G.
  - (3) Blow air into the mass air flow meter, and check that the voltage fluctuates.

**Standard:**

Tester Connection	Specified Condition
VG (3) – E2G (2)	Sensor output voltage fluctuates between 0.3 V and 4.8 V

- (c) Inspect resistance.
  - (1) Measure the resistance between the terminals of the mass air flow meter.

**Standard:**

Tester Connection	Specified Condition
THA (4) – E2 (5)	13.6 to 18.4 kΩ at -20°C (-4°F)
THA (4) – E2 (5)	2.21 to 2.69 kΩ at 20°C (68°F)
THA (4) – E2 (5)	0.49 to 0.67 kΩ at 60°C (140°F)

- (d) Reinstall the mass air flow meter.

**OK**

**NG** **REPLACE MASS AIR FLOW METER**

**5 INSPECT ENGINE COOLANT TEMPERATURE SENSOR(RESISTANCE)**

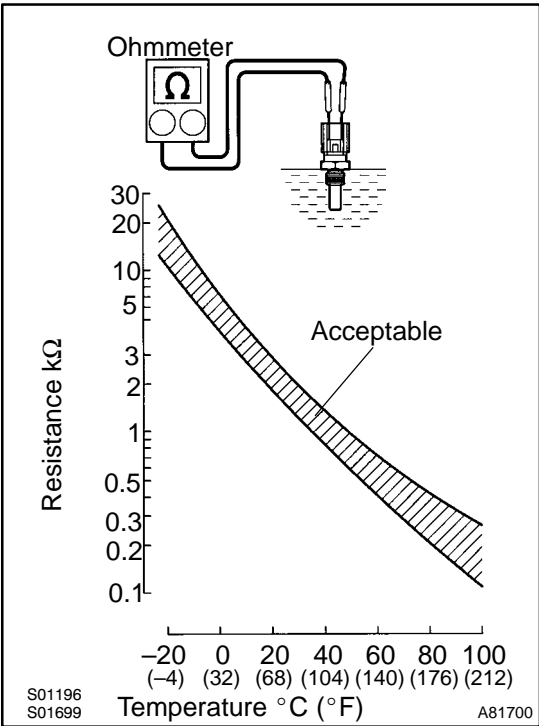

- (a) Remove the engine coolant temperature sensor.
- (b) Measure the resistance between the terminals of the engine coolant temperature sensor.

**Standard:**

Tester Connection	Specified Condition
1 - 2	2 to 3 kΩ at 20°C (68°F)
1 - 2	0.2 to 0.4 kΩ at 80°C (176°F)

**NOTICE:**

**When checking the engine coolant temperature sensor in water, be careful not to allow water to contact the terminals. After checking, dry the sensor.**

**HINT:**

Alternate procedure: Connect an ohmmeter to the installed engine coolant temperature sensor and read the resistance. Use an infrared thermometer to measure the engine temperature in the immediate vicinity of the sensor. Compare these values to the resistance/temperature graph. Change the engine temperature (warm up or allow to cool down) and repeat the test.

- (c) Reinstall the engine coolant temperature sensor.

**NG** → **REPLACE ENGINE COOLANT TEMPERATURE SENSOR**

**OK**

**6 CHECK FOR SPARK AND IGNITION (See page 18-3)**

**OK: Spark occurs.**

**NG** → **REPAIR OR REPLACE IGNITION SYSTEM COMPONENTS**

**OK**

**7 CHECK FUEL PRESSURE (See page 11-7)**

- (a) Check the fuel pressure (high or low pressure).

**OK:**

**Fuel pressure: 304 to 343 kPa (3.1 to 3.5 kgf·cm<sup>2</sup>, 44 to 50 psi)**

**NG** → **REPAIR OR REPLACE FUEL SYSTEM**

**OK**

<b>8</b>	<b>CHECK FOR EXHAUST GAS LEAKAGE</b>
----------	--------------------------------------

OK: No gas leak.

NG

**REPAIR OR REPLACE EXHAUST GAS LEAKAGE POINT (See page 15-1)**

OK

<b>9</b>	<b>READ VALUE OF HAND-HELD TESTER OR OBD II SCAN TOOL(OUTPUT VOLTAGE OF AIR FUEL RATIO SENSOR (BANK 1 SENSOR 1))</b>
----------	--

- (a) Connect the hand-held tester or the OBD II scan tool to the DLC 3.
- (b) Put the engine in inspection mode (see page 05-1).
- (c) Warm up the A/F sensors (bank 1 sensor 1) by running the engine at 2,500 rpm with the accelerator pedal depressed more than 60 % for approximately 90 seconds.
- (d) Read A/F sensor voltage output on the OBD II scan tool or the hand-held tester.
- (e) Hand-held tester only:  
On the hand-held tester, enter the menus: ENHANCED OBD II / ENGINE AND ECT / SNAPSHOT / MANUAL SNAPSHOT / USER DATA.
- (f) Select "AFS B1 S1/ENGINE SPD" and press button "YES".
- (g) Monitor the A/F sensor voltage carefully.
- (h) Check the A/F sensor voltage output under the following conditions:
  - (1) Put the engine in inspection mode and allow the engine to idle for 30 seconds.
  - (2) Put the engine in inspection mode and running the engine at 2,500 rpm with the accelerator pedal depressed more than 60 % (where engine RPM is not suddenly changed).
  - (3) Deactivate the inspection mode and drive the vehicle with shift position "B" range.
  - (4) Accelerate the vehicle to 44 mph (70 km/h) and quickly release the accelerator pedal so that the throttle valve is fully closed.

**CAUTION:**

- **Strictly observe of posted speed limits, traffic laws, and road conditions when performing these drive patterns.**
- **Do not drive the vehicle without deactivating inspection mode, otherwise damaging the trans-axle may result.**

**Standard:**

**Condition (1) and (2)**

**Voltage changes in the vicinity of 3.3 V (0.66 V)\* (between approximately 3.1 to 3.5 V) as shown in the illustration.**

**Condition (4)**

**A/F sensor voltage increases to 3.8 V (0.76 V)\* or more during engine deceleration (when fuel cut) as shown in the illustration.**

**\*: Voltage when using the OBD II scan tool.**



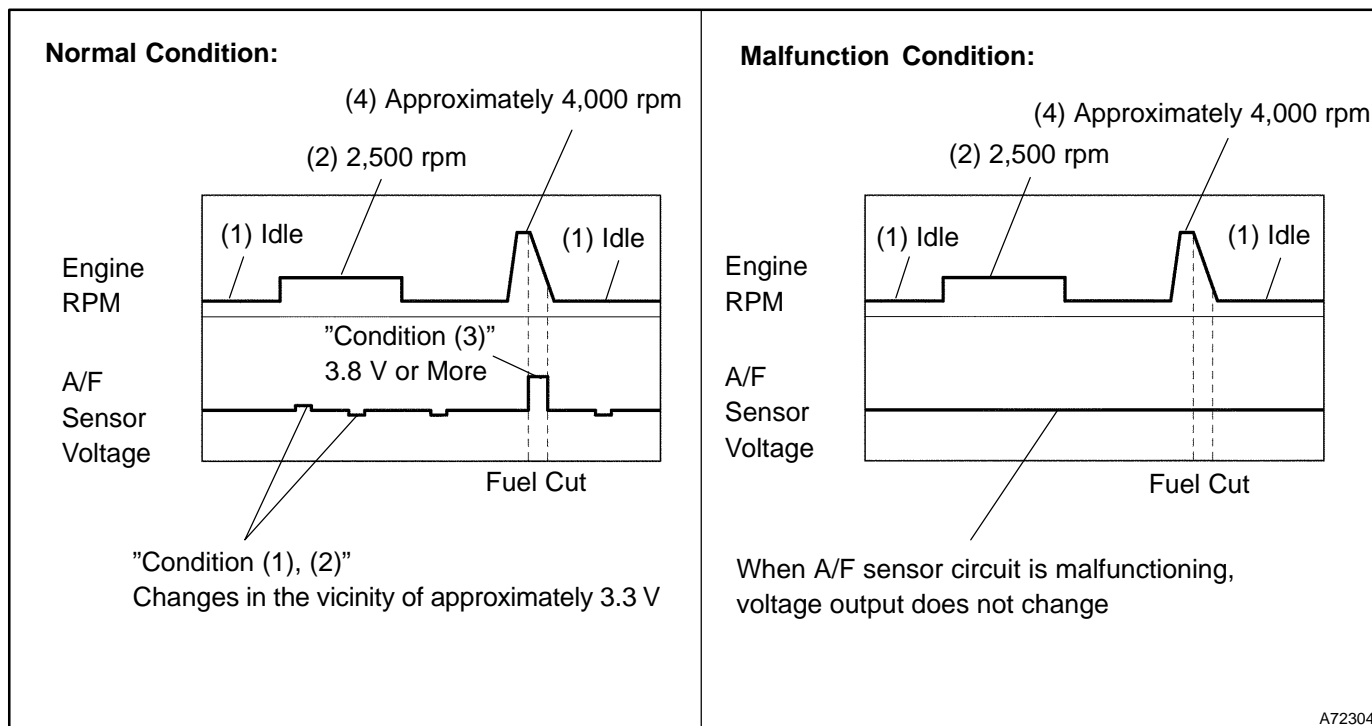

A72304

## HINT:

- Whenever the output voltage of the A/F sensor remains at approximately 3.3 V (0.660 V)\* (see diagram Malfunction Condition) under any condition as well as the above conditions, the A/F sensor may have an open-circuit. (This will happen also when the A/F sensor heater has an open-circuit.)
- Whenever the output voltage of the A/F sensor remains at a certain value of approximately 3.8 V (0.76 V)\* or more, or 2.8 V (0.56 V)\* or less (see diagram Malfunction Condition) under any condition as well as the above conditions, the A/F sensor may have a short-circuit.
- The ECM will stop fuel injection (fuel cut) during engine deceleration. This will cause a LEAN condition and should result in a momentary increase in A/F sensor voltage output.
- The ECM must establish a closed throttle position learned value to perform fuel cut. If the battery terminal was reconnected, the vehicle must be driven over 10 mph to allow the ECM to learn the closed throttle position.
- When the vehicle is driven:  
The output voltage of the A/F sensor may be below 2.8 V (0.76 V)\* during fuel enrichment. For the vehicle, this translates to a sudden increase in speed with the accelerator pedal fully depressed when trying to overtake another vehicle. The A/F sensor is functioning normally.
- The A/F sensor is a current output element, and therefore the current is converted into voltage inside the ECM. If measuring voltage at connectors of A/F sensor or ECM, you will observe a constant voltage.

\*: Voltage when using the OBD II scan tool.

OK

Go to step 17

NG

**10 INSPECT AIR FUEL RATIO SENSOR(HEATER RESISTANCE)**

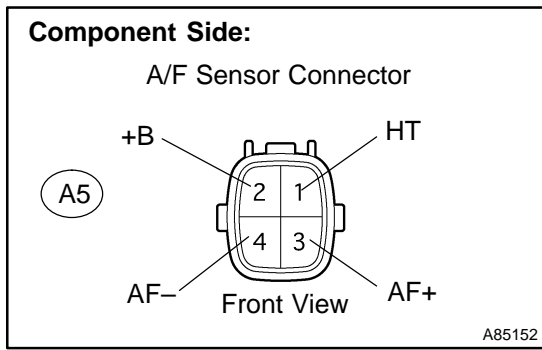

- (a) Disconnect the A5 A/F sensor connector.
- (b) Measure the resistance between the terminals of the A/F sensor.

**Standard:**

Tester Connection	Specified Condition
HT (1) - +B (2)	1.8 to 3.4 Ω at 20°C (68 °F)

- (c) Reconnect the A/F sensor connector.

**NG** → REPLACE AIR FUEL RATIO SENSOR

**OK**

**11 INSPECT INTEGRATION RELAY(EFI M RELAY)**

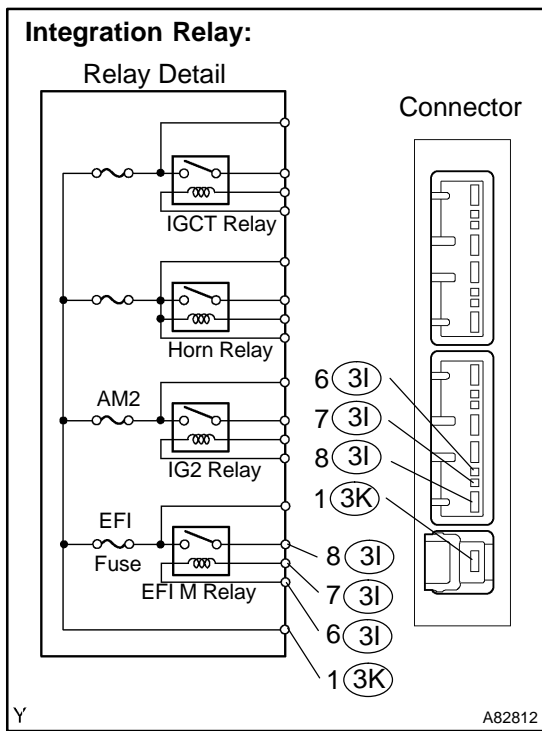

- (a) Remove the integration relay from the engine room R/B.
- (b) Inspect the EFI M relay.

**Standard:**

Tester Connection	Specified Condition
(3K-1) - (3I-8)	10 kΩ or higher
(3K-1) - (3I-8)	Below 1 Ω (Apply battery voltage to terminals 3I-6 and 3I-7)

- (c) Reinstall the integration relay.

**NG** → REPLACE INTEGRATION RELAY

**OK**

**12 CHECK HARNESS AND CONNECTOR(A/F SENSOR - ECM)**

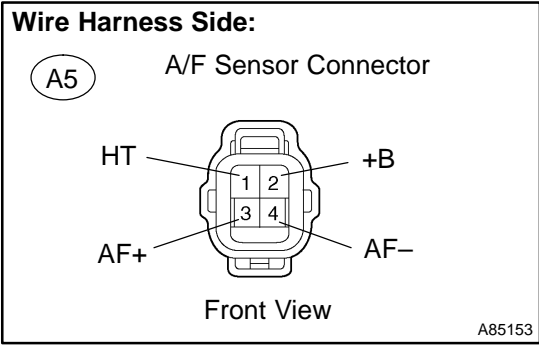

- (a) Disconnect the A5 A/F sensor connector.
- (b) Disconnect the E5 ECM connector.
- (c) Check the resistance between the wire harness side connectors.

**Standard (Check for open):**

Tester Connection	Specified Condition
AF+ (A5-3) - A1A+ (E5-23)	Below 1 Ω
AF- (A5-4) - A1A- (E5-22)	Below 1 Ω
HT (A5-1) - HA1A (E5-7)	Below 1 Ω

**Standard (Check for short):**

Tester Connection	Specified Condition
AF+ (A5-3) or A1A+ (E5-23) - Body ground	10 kΩ or higher
AF- (A5-4) or A1A- (E5-22) - Body ground	10 kΩ or higher
HT (A5-1) or HA1A (E5-7) - Body ground	10 kΩ or higher

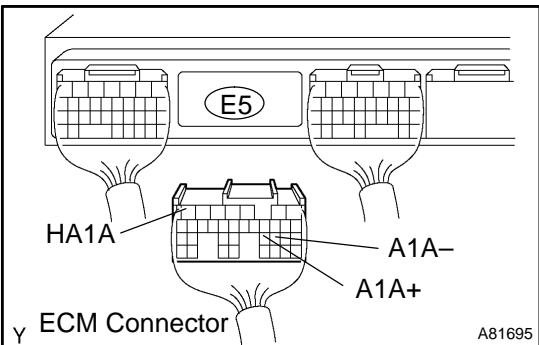

- (d) Reconnect the A/F sensor connector.
- (e) Reconnect the ECM connector.

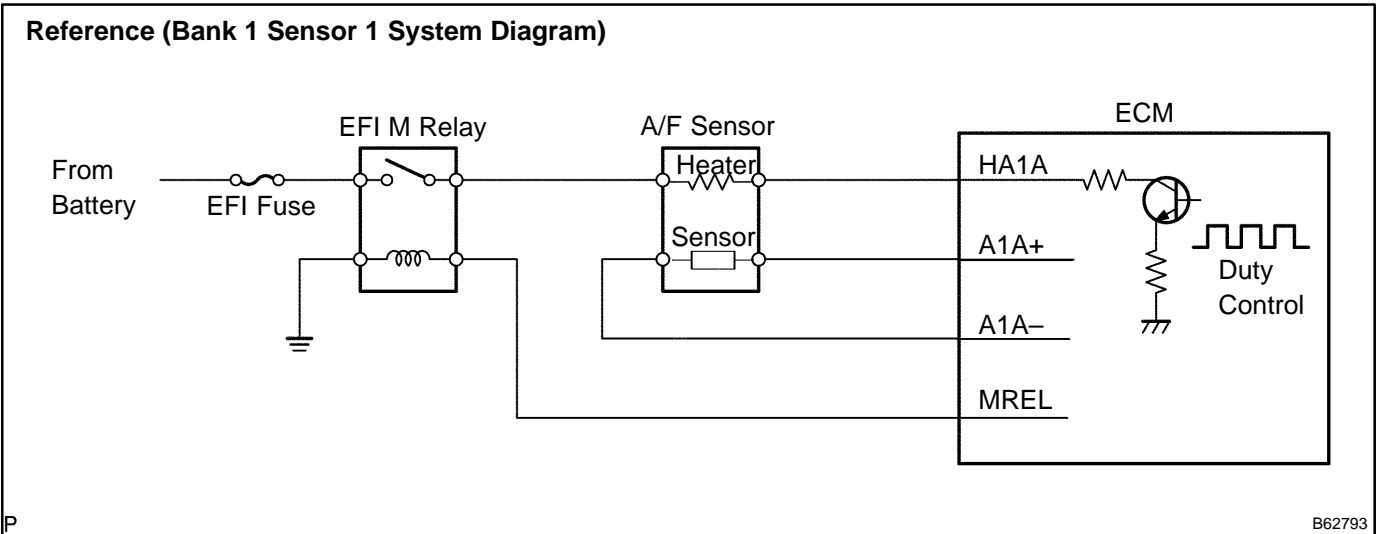

**NG REPAIR OR REPLACE HARNESS OR CONNECTOR**

**OK**

<b>13</b>	<b>REPLACE AIR FUEL RATIO SENSOR</b>
-----------	--------------------------------------

<b>GO</b>
-----------

<b>14</b>	<b>PERFORM CONFIRMATION DRIVING PATTERN</b>
-----------	---

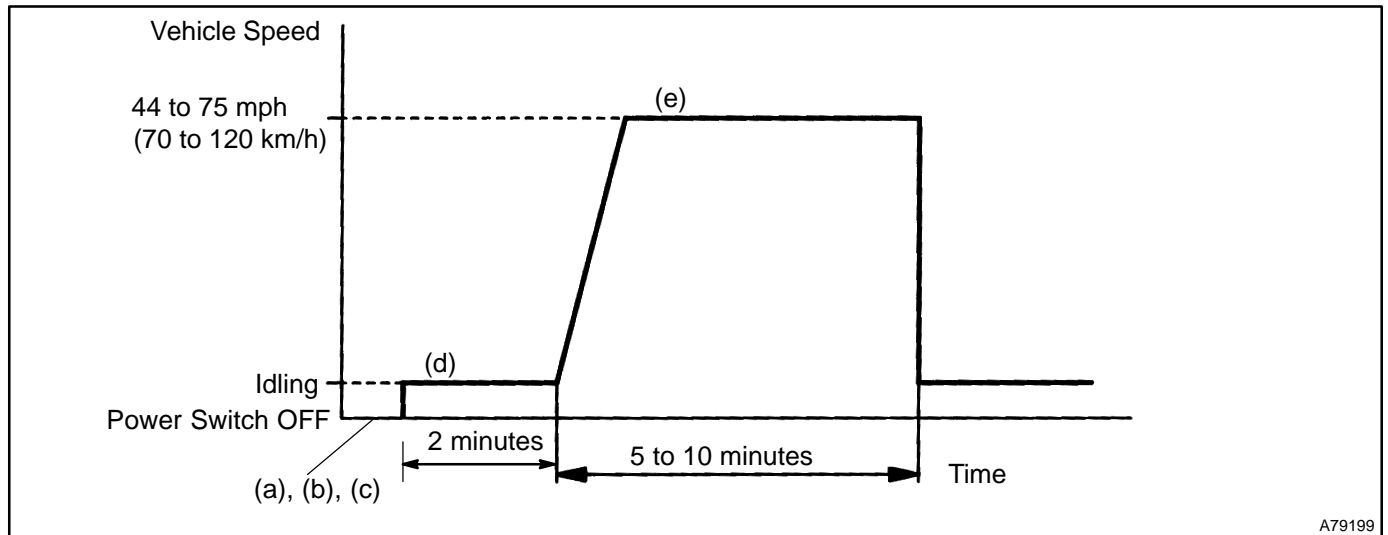

- (a) Clear the DTCs (see page 05-41).
- (b) Connect the hand-held tester to the DLC3.
- (c) Switch the ECM from normal mode to check mode using the hand-held tester (see page 05-45).
- (d) Put the engine in inspection mode, and start the engine and warm it up with all the accessory switches OFF.
- (e) Deactivate inspection mode and drive the vehicle at 44 to 75 mph (70 to 120 km/h) and engine speed of 1,100 to 3,200 rpm for 5 to 10 minutes.

**HINT:**

If malfunction exists, the MIL will be illuminated during step (e).

**NOTICE:**

- If the conditions in this test are not strictly followed, no malfunction will be detected. If you do not have a hand-held tester, turn the power switch OFF after performing steps (d) and (e), then perform step (e) again.
- Do not drive the vehicle without deactivating inspection mode, otherwise damaging the trans-axle may result.

<b>GO</b>
-----------

**15 READ OUTPUT DTCS(SEE IF DTC P0171 AND/OR P0172 ARE OUTPUT AGAIN)**

- (a) Connect the hand-held tester or the OBD II scan tool to the DLC3.
- (b) Turn the power switch ON (IG).
- (c) Turn the hand-held tester or the OBD II scan tool ON.
- (d) On the hand-held tester, select the item: DIAGNOSIS / ENHANCED OBD II / ENGINE AND ECT / DTC INFO / CURRENT CODES.
- (e) Read DTCs using the hand-held tester or the OBD II scan tool.

**Result:**

Display (DTC Output)	Proceed to
No output	A
P0171 and/or P0172	B

**B** → **REPLACE ECM (See page 10-24) AND PERFORM CONFIRMATION DRIVING PATTERN (Refer to step 14)**

**A**

**16 CONFIRM IF VEHICLE HAS RUN OUT OF FUEL IN PAST**

**NO** → **CHECK FOR INTERMITTENT PROBLEMS (See page 05-17)**

**YES**

**DTCS ARE CAUSED BY RUNNING OUT OF FUEL (DTCS P0171 and/or P0172)**

**17 PERFORM CONFIRMATION DRIVING PATTERN**

**HINT:**

Clear all DTCs prior to performing the confirmation driving pattern (Refer to step 14).

**GO**

**18 READ OUTPUT DTCS(SEE IF DTC P0171 AND/OR P0172 ARE OUTPUT AGAIN)**

- (a) Connect the hand-held tester or the OBD II scan tool to the DLC3.
- (b) Turn the power switch ON (IG).
- (c) Turn the hand-held tester or the OBD II scan tool ON.
- (d) On the hand-held tester, select the item: DIAGNOSIS / ENHANCED OBD II / ENGINE AND ECT / DTC INFO / CURRENT CODES.
- (e) Read DTCs using the hand-held tester or the OBD II scan tool.

**Result:**

Display (DTC Output)	Proceed to
P0171 and/or P0172	A
No output	B

**B** → **Go to step 22**

**A**

<b>19</b>	<b>REPLACE AIR FUEL RATIO SENSOR</b>
-----------	--------------------------------------

**GO**

<b>20</b>	<b>PERFORM CONFIRMATION DRIVING PATTERN</b>
-----------	---

HINT:

Clear all DTCs prior to performing the confirmation driving pattern (Refer to step 14).

**GO**

<b>21</b>	<b>READ OUTPUT DTCS(SEE IF DTC P0171 AND/OR P0172 ARE OUTPUT AGAIN)</b>
-----------	---

- (a) Connect the hand-held tester or the OBD II scan tool to the DLC3.
- (b) Turn the power switch ON (IG).
- (c) Turn the hand-held tester or the OBD II scan tool ON.
- (d) On the hand-held tester, select the item: DIAGNOSIS / ENHANCED OBD II / ENGINE AND ECT / DTC INFO / CURRENT CODES.
- (e) Read DTCs using the hand-held tester or the OBD II scan tool.

**Result:**

Display (DTC Output)	Proceed to
No output	A
P0171 and/or P0172	B

**B**

**REPLACE ECM (See page 10-24) AND PERFORM CONFIRMATION DRIVING PATTERN (Refer to step 14)**

**A**

<b>22</b>	<b>CONFIRM IF VEHICLE HAS RUN OUT OF FUEL IN PAST</b>
-----------	---

**NO**

**CHECK FOR INTERMITTENT PROBLEMS (See page 05-17)**

**YES**

**DTCS ARE CAUSED BY RUNNING OUT OF FUEL**