

REPLACEMENT

HINT:

- The installation procedures are the removal procedures in reverse order. However, only installation procedures requiring additional information are included.
- A bolt without a torque specification is shown in the standard bolt chart (see page 03-2).

1. REMOVE ROOF HEADLINING ASSY (See page 76-28)

- Remove the front door scuff plate LH and RH.
- Remove the cowl side trim board LH and RH.
- Remove the front door opening trim weatherstrip LH and RH.
- Remove the front pillar garnish corner piece LH and RH.
- Remove the front pillar garnish LH and RH.
- Remove the visor LH and RH.
- Remove the 2 visor holders.
- Remove the assist grip.
- Remove the map lamp.
- Partially remove the roof headlining.

HINT:

Do not remove the roof headlining completely. Slightly lower the front section of the roof headlining so that the windshield glass can be removed later in step 5.

2. REMOVE INNER REAR VIEW MIRROR ASSY (See page 70-52)

3. REMOVE COWL TOP VENTILATOR LOUVER (See page 66-14)

- Remove the hood cowl top seal.
- Remove the front wiper arm LH and RH.
- Remove the cowl top ventilator louver LH and RH.

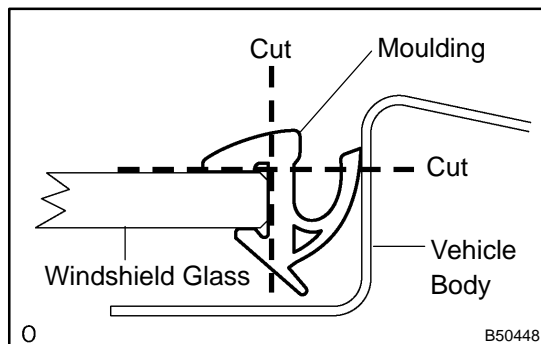

4. REMOVE WINDSHIELD MOULDING OUTSIDE

- Using a knife, cut off the moulding, as shown in the illustration.

NOTICE:

Be careful not to damage the vehicle body with the knife.

- Remove the remaining moulding.

HINT:

Make a partial cut in the moulding. Then pull and remove it by hand.

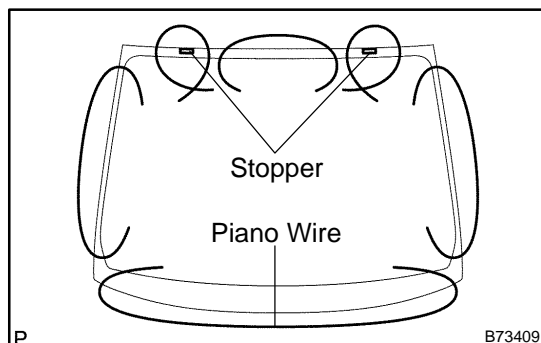

5. REMOVE WINDSHIELD GLASS

- From the interior, insert piano wires between the vehicle body and glass, as shown in the illustration.
- Tie objects that can serve as handles (for example, wooden blocks) to all wire ends.

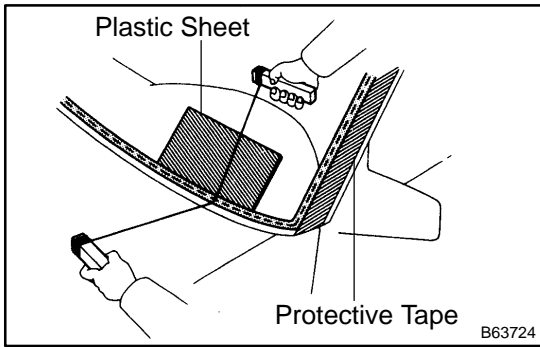

HINT:

Apply protective tape to the outer surface of the vehicle body to prevent its surface from being scratched.

NOTICE:

- **When separating the glass from the vehicle, be careful not to damage the vehicle's paint or interior / exterior ornaments.**
- **To prevent the safety pad from being scratched when removing the glass, place a plastic sheet between the piano wire and safety pad.**

- (c) Cut through the adhesive by pulling the piano wire around the glass.
- (d) Disengage the stoppers.
- (e) Using a suction cup, remove the glass.

NOTICE:

Leave as much adhesive on the vehicle body as possible when removing the glass.

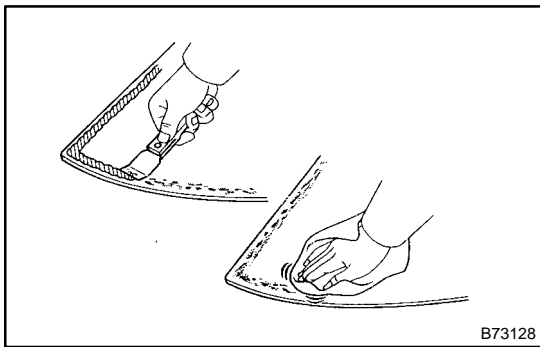

6. CLEAN WINDSHIELD GLASS

- (a) Using a scraper, remove the damaged stoppers, dam and adhesive sticking to the glass.
- (b) Clean the outer circumference of the glass with white gasoline.

NOTICE:

- **Do not touch the glass surface after cleaning it.**
- **Even if using new glass, clean the glass with white gasoline.**

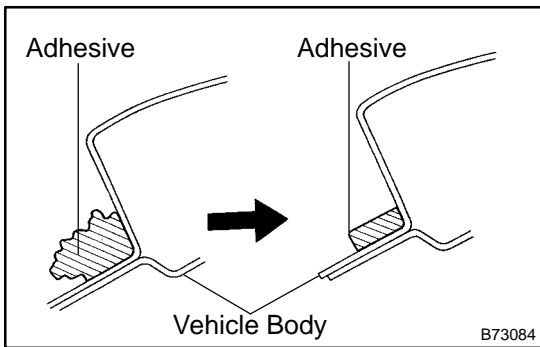

7. CLEAN VEHICLE BODY

- (a) Clean and shape the contact surface of the vehicle body.
 - (1) Using a knife, cut away any rough adhesive on the contact surface of the vehicle body to ensure the appropriate surface shape.

NOTICE:

Be careful not to damage the vehicle body.

HINT:

Leave as much adhesive on the vehicle body as possible.

- (2) Clean the contact surface of the vehicle body with a piece of shop rag saturated with cleaner.

HINT:

Even if all the adhesive has been removed, clean the vehicle body.

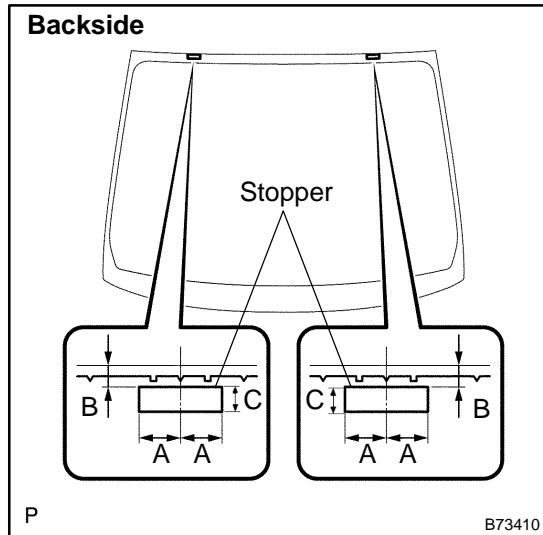

8. INSTALL WINDSHIELD GLASS STOPPER NO. 2

- (a) Coat the installation part of the stoppers with Primer G.

NOTICE:

- **Allow the primer coating to dry for 3 minutes or more.**
- **Throw away any leftover Primer G.**
- **Do not apply too much Primer G.**

- (b) Install 2 new stoppers onto the glass, as shown in the illustration.

Specification:

Area	Measurement
A	40 mm (1.57 in.)
B	7.7 mm (0.30 in.)
C	12.5 mm (0.49 in.)

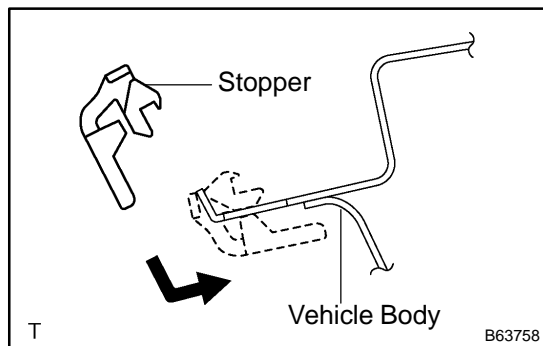

9. INSTALL WINDSHIELD GLASS STOPPER NO. 1

- (a) Install 2 new stoppers to the vehicle body, as shown in the illustration.

10. INSTALL WINDOW GLASS ADHESIVE DAM

(a) Coat the installation part of the window glass adhesive dam with Primer G.

NOTICE:

- Allow the primer coating to dry for 3 minutes or more.
 - Throw away any leftover Primer G.
 - Do not apply too much Primer G.
- (b) Install a new dam, applying double-sided tape all the way around the glass except where the stoppers are installed, as shown in the illustration.

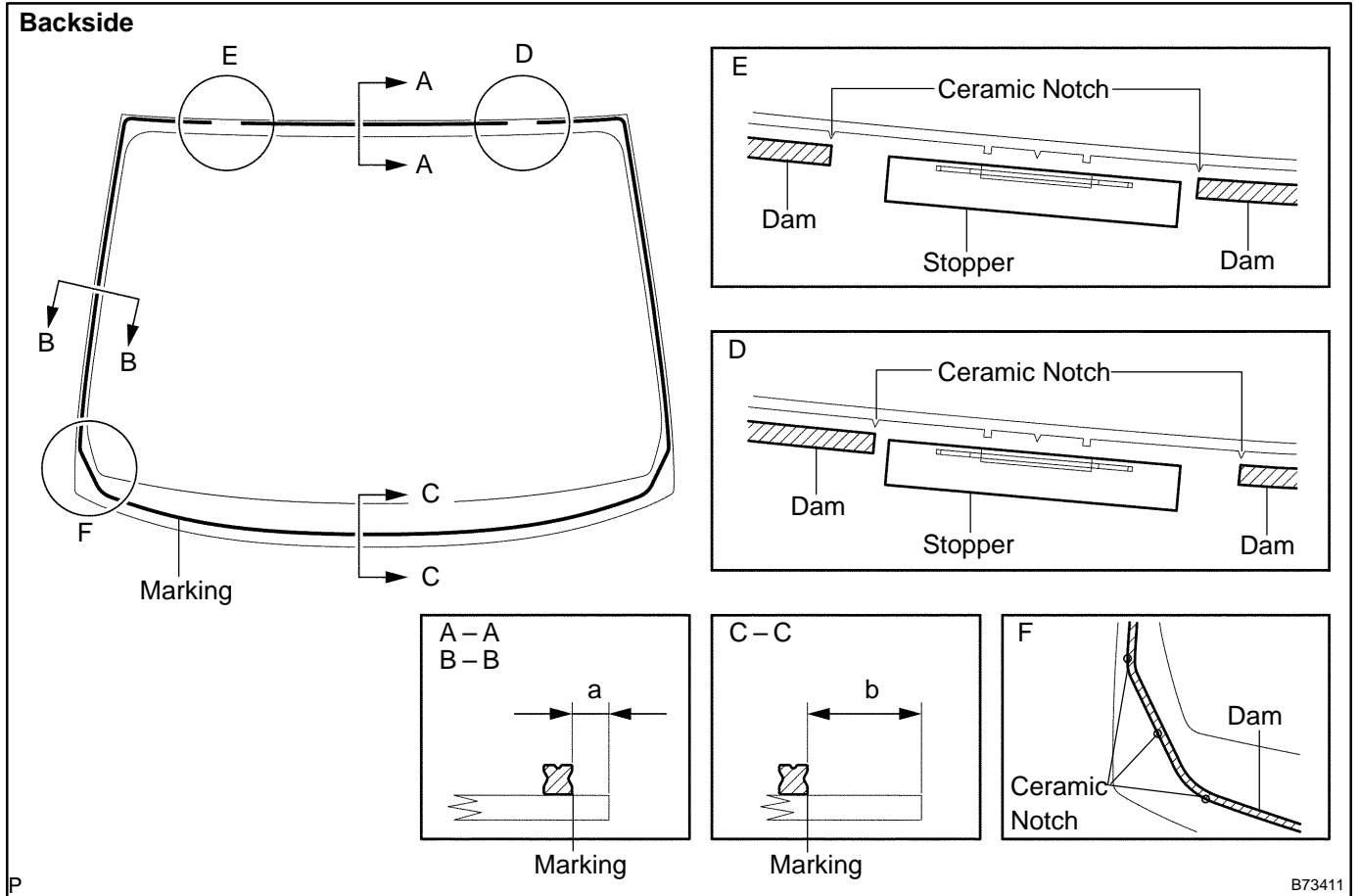

Specification:

Area	Measurement
a	7 mm (0.28 in.)
b	27.5 mm (1.08 in.)

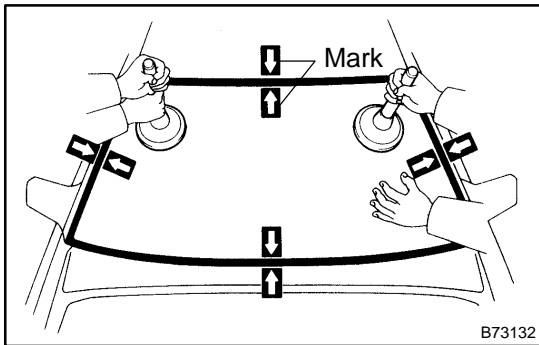

11. INSTALL WINDSHIELD GLASS

(a) Position the glass.

- (1) Using a suction cup, place the glass in the correct position.
- (2) Check that the whole contact surface of the glass rim is perfectly even.
- (3) Place reference marks between the glass and vehicle body.

NOTICE:

Check that the stoppers are attached to the vehicle body correctly.

HINT:

When reusing the glass, check and correct the reference mark positions.

- (4) Using a suction cup, remove the glass.

(b) Using a brush, coat the exposed part of the vehicle body with Primer M.

NOTICE:

- **Allow the primer coating to dry for 3 minutes or more.**
- **Do not coat the adhesive with Primer M.**
- **Throw away any leftover Primer M.**
- **Do not apply too much Primer M.**

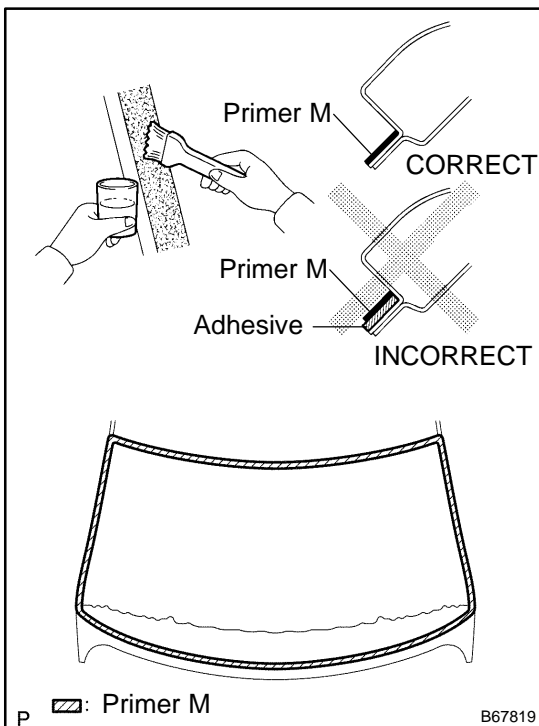

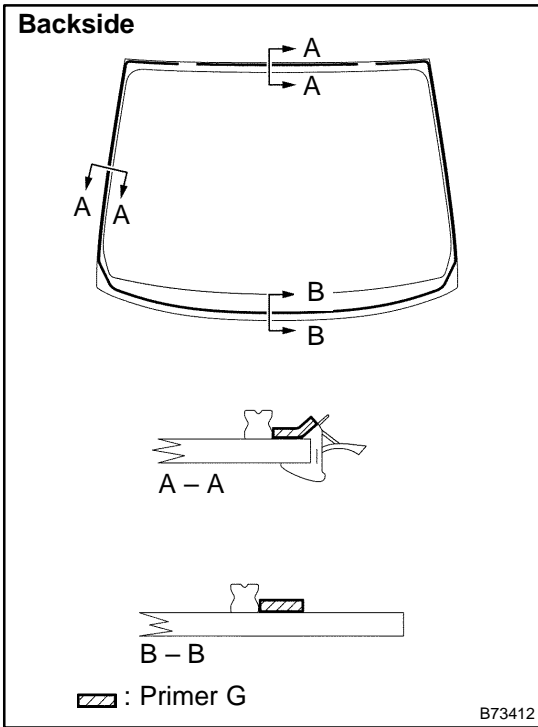

(c) Using a brush or sponge, coat the edge of the glass and the contact surface with Primer G.

HINT:

If an area other than that specified is coated by accident, wipe off the primer with a clean shop rag before it dries.

NOTICE:

- Allow the primer coating to dry for 3 minutes or more.
- Throw away any leftover Primer G.
- Do not apply too much Primer G.

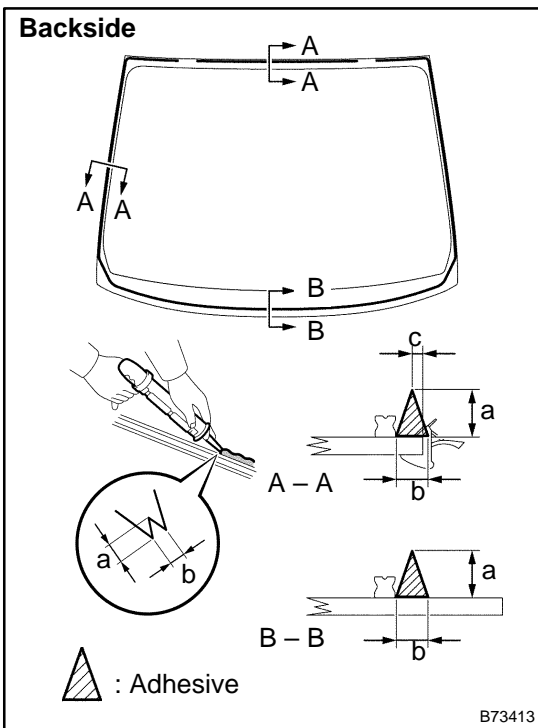

(d) Apply adhesive.

Adhesive: Part No. 08850-00801 or equivalent

- (1) Cut off the tip of the cartridge nozzle, as shown in the illustration.

HINT:

After cutting off the tip, use all adhesive within the time described in the table below.

Usage timeframe:

Temperature	Usage Timeframe
35°C (95°F)	15 minutes
20°C (68°F)	1 hour 40 minutes
5°C (41°F)	8 hours

- (2) Load the sealer gun with the cartridge.
- (3) Coat the glass with adhesive, as shown in the illustration.

Specification:

Area	Measurement
a	12.5 mm (0.49 in.)
b	8 mm (0.31 in.)
c	3 mm (0.12 in.)

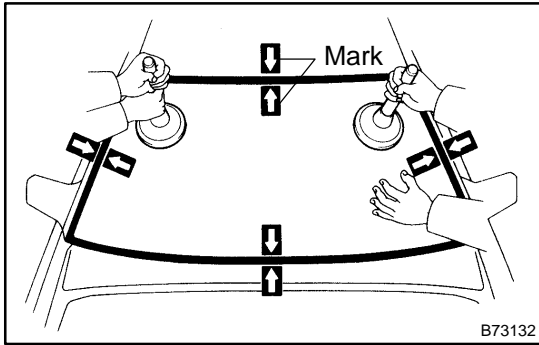

- (e) Install the glass to the vehicle body.
- (1) Using a suction cup, position the glass so that the reference marks are aligned. Press it in gently along the rim.

NOTICE:

- Allow the primer coating to dry for 3 minutes or more.
 - Check that the stoppers are attached to the vehicle body correctly.
 - Check that the vehicle body and glass have a small gap between them.
- (2) Lightly press the front surface of the glass to ensure that the glass is securely fit to the vehicle body.

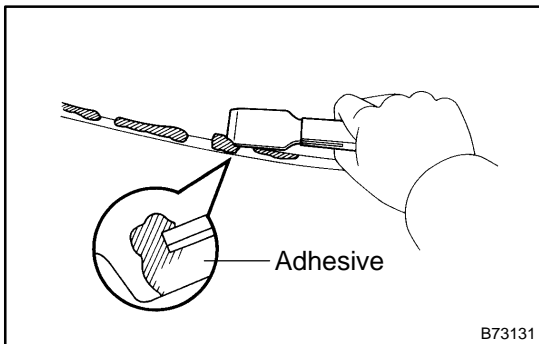

- (3) Using a scraper, remove any excess or protruding adhesive.

HINT:

Apply adhesive onto the glass rim.

12. INSTALL WINDSHIELD MOULDING OUTSIDE

- (a) Using a brush or sponge, coat the edge of the glass and the contact surface with Primer G.

NOTICE:

- Allow the primer coating to dry for 3 minutes or more.
- Throw away any leftover Primer G.
- Do not apply too much Primer G.

- (b) Install the moulding before the adhesive dries.

NOTICE:

Do not drive the vehicle for the amount of time described in the table below.

Minimum time:

Temperature	Minimum time prior to driving vehicle
35°C (95°F)	1 hour 30 minutes
20°C (68°F)	5 hours
5°C (41°F)	24 hours

13. CHECK FOR LEAKS AND REPAIR

- (a) Conduct a leak test after the adhesive has completely hardened.
- (b) Seal any leaks with auto glass sealer.