

■ BRAKE CONTROL SYSTEM

1. General

- An ECB (Electronically Controlled Brake) system has been adopted in the brake control system of the '04 Prius. The ECB system calculates the required braking force based on the amount of pedal effort and force applied by the driver. Then, this system applies the required braking force (which consists of a regenerative brake force generated by MG2 and a brake force generated by the hydraulic brake system) and effectively absorbs the energy.
- The ECB ECU, which controls this system, is integrated into the skid control ECU, and effects comprehensive control together with the hydraulic brake control system (consisting of ABS with EBD, brake assist and Enhanced VSC*).
- A brake control system warning light has been newly adopted accompanied by the adoption of the ECB system.
- The Enhanced VSC* system provides the steering assist in order to facilitate steering operation of the driver depending on vehicle situations by effecting cooperative control in conjunction with EPS, in addition to the VSC system that gives the general braking control function.
- On the '04 Prius, the motor traction control system has been adopted. This system minimizes a slippage of the drive wheels and generates the appropriate drive force for road surface condition by applying the hydraulic brake control to the wheels in slipping, in addition to the control function protecting the planetary gear and the motor that has been provided by the THS system on the previous model.
For details, refer to HV ECU control in THS-II section on page THS-46.
- On the '04 Prius, the conventional brake booster portion has been discontinued. Instead, it consists of brake input, power supply, and hydraulic pressure control portions.
During normal braking, the fluid pressure generated by the master cylinder does not directly actuate the wheel cylinders, but serves as a hydraulic pressure signal. Instead, the actual control pressure is obtained by regulating the fluid pressure of the hydraulic power source in the brake actuator, which actuates the wheel cylinders.
- The brake system of the '04 Prius starts with one of the actions the power switch is turned ON, etc.
- The skid control ECU maintains communication with the EPS ECU and the HV ECU via CAN (Controller Area Network). For details, refer to Multiplex Communication on page BE-47.
- The skid control ECU has been changed from 16-bit CPU to 32-bit CPU to increase the for processing the signals.

*: Option

► Outline of Brake Control System ◀

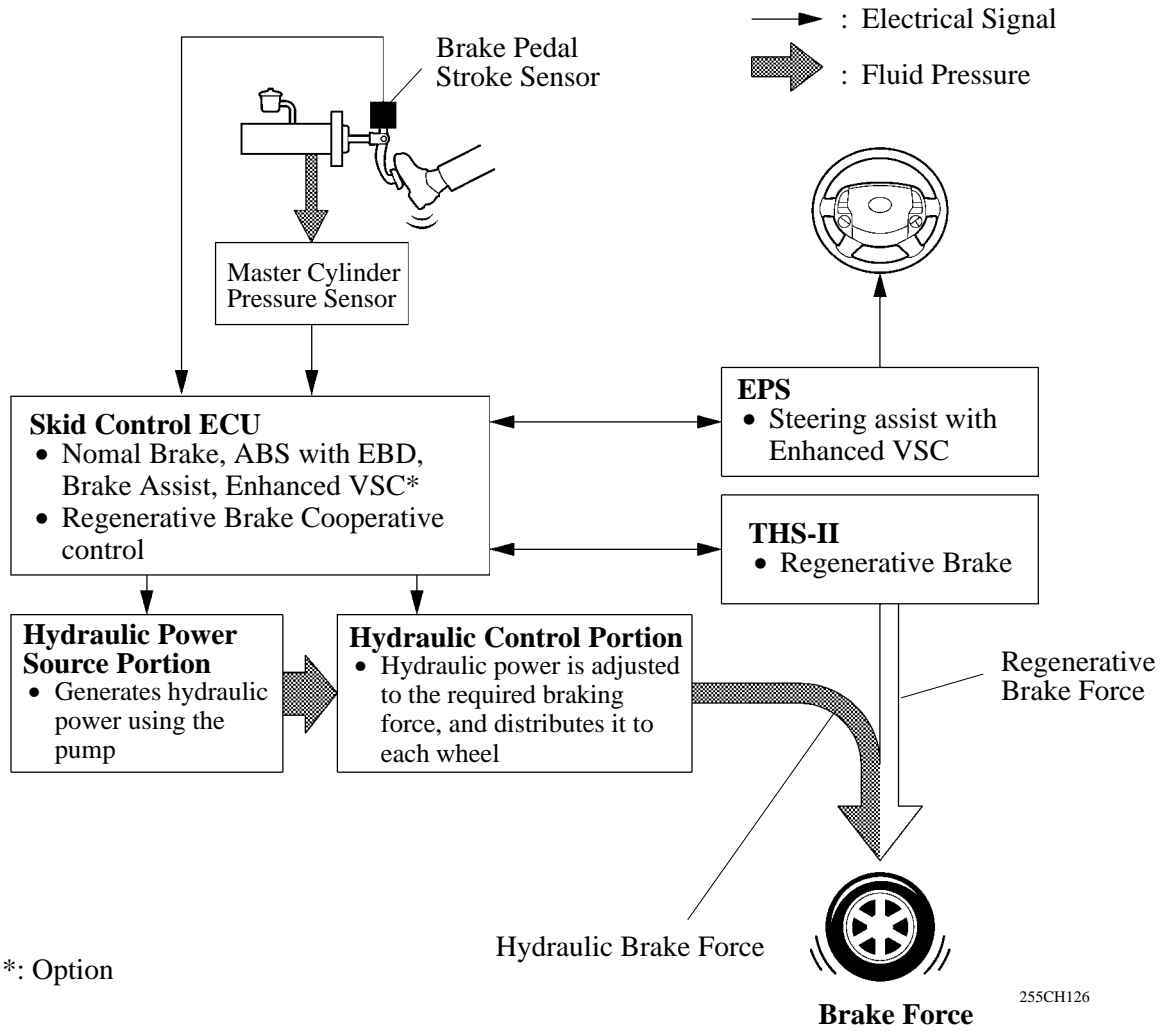

*: Option

The brake system of '04 Prius has a following function:

Brake Control System	Function	Outline
ECB System	Regenerative Brake Cooperative Control	Controls the hydraulic brake in order to recover the electrical energy by utilizing the regenerative brake of the THS-II system as much as possible.
	Enhanced VSC* (Enhanced Vehicle Stability Control)	<ul style="list-style-type: none"> • The Enhanced VSC system helps prevent the vehicle from slipping sideways as a result of strong front wheel skid or strong rear wheel skid during cornering. • Effects cooperative control with the EPS ECU in order to provide steering assist in accordance with the operating conditions of the vehicle.
	ABS (Anti-lock Brake System)	The ABS helps prevent the wheels from locking when the brakes are applied firmly or when braking on a slippery surface.
	EBD (Electronic Brake force Distribution)	The EBD control utilizes ABS, realizing the proper brake force distribution between front and rear wheels in accordance with the driving conditions. In addition, during cornering braking, it also controls the brake forces of right and left wheels, helping to maintain the vehicle behavior.
	Brake Assist	The Brake Assist has two functions: <ul style="list-style-type: none"> • To increase the braking force if the brake pedal operation is not sufficient when urgent braking is needed. • To increase the braking force if stronger brake force is required.

*: Option

2. Outline of Regenerative Brake Cooperative Control

General

- Regenerative brake consists of a resistance force that is generated at the rotational axle in the reverse direction of the rotation of the generator (MG2) that is generating electricity. The greater the generated amperage (battery charging amperage), the greater will be the resistance force.

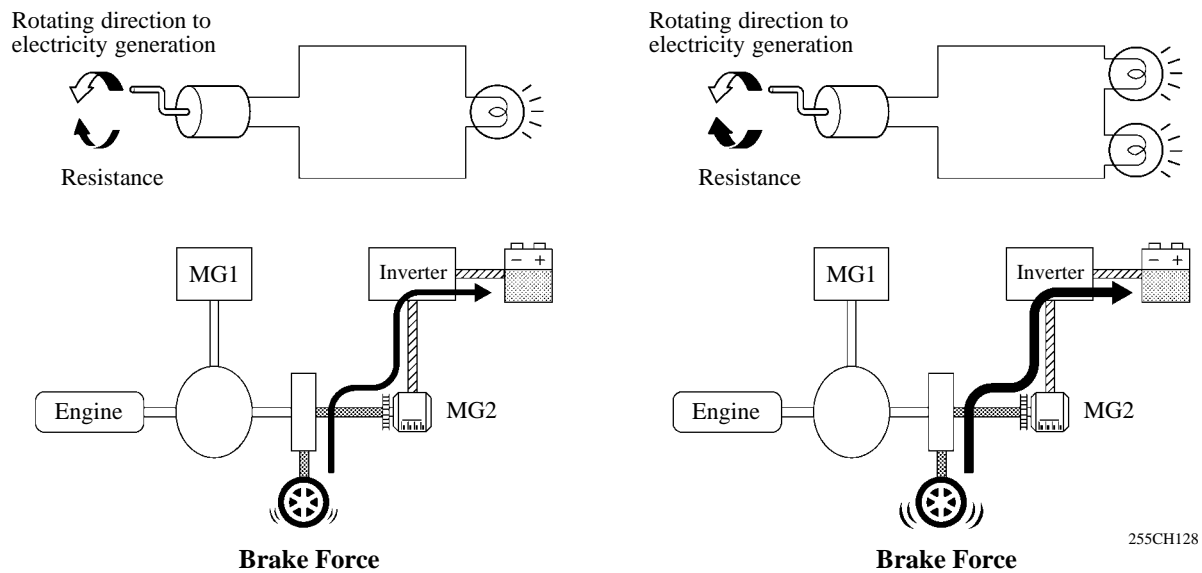

- The drive axle and MG2 are joined mechanically. When the drive wheels rotate MG2 and cause it to operate as a generator, a regenerative brake force of MG2 is transmitted to the drive wheels. This force is controlled by the THS-II system, which controls the generation of electricity. The regenerative brake cooperative control does not rely solely on the braking force of the hydraulic brake system to supply the brake force required by the driver. Instead, by effecting cooperative control with the THS-II system, this control provides a joint braking force provided by the regenerative brake and the hydraulic brake. As a result, this control minimizes the loss of the kinetic energy associated with the normal hydraulic brake, and recovers this energy by converting it into electrical energy.
- On the '04 Prius, the power output of MG2 has increased through the adoption of the THS-II system, which has resulted in improving the regenerative brake force. In addition, the distribution of the brake force has been improved through the adoption of the ECB system, effectively increasing the use range of the regenerative brake. These attributes enhance the system's ability to recover electrical energy, which contributes to fuel economy.

► Improved Regenerative Brake ◀

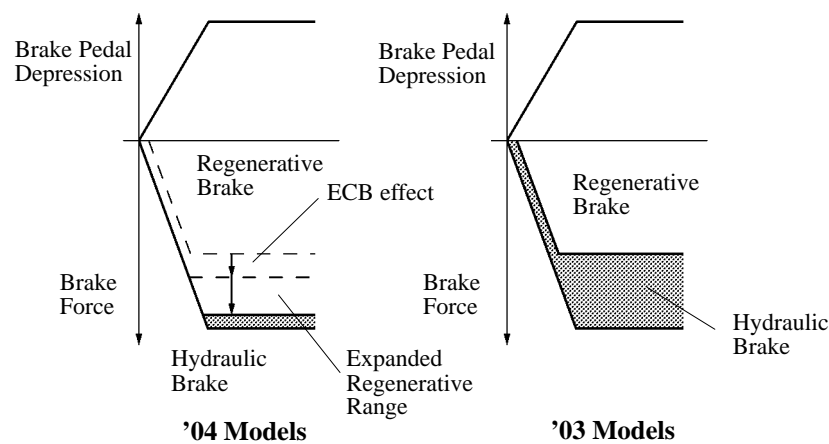

Apportioning of the Brake Force

- The apportioning of the brake force between the hydraulic brake and the regenerative brake varies by the vehicle speed and time.
- The apportioning of the brake force between the hydraulic brake and the regenerative brake is accomplished by controlling the hydraulic brake so that the total brake force of the hydraulic brake and the regenerative brake matches the brake force required by the driver.
- If the regenerative brake becomes inoperative due to a malfunction in the THS-II system, the brake system effects control so that the entire brake force required by the driver is supplied with the hydraulic brake system.

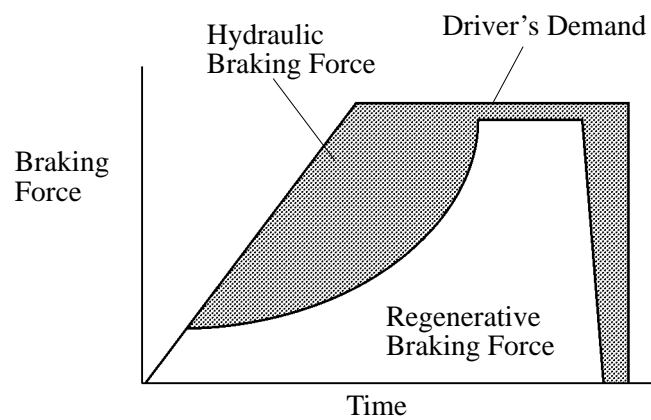
► Imagery Drawing ◀**Changes in Braking Force Apportionment**

255CH129

3. Outline of EBD Control

General

The distribution of the brake force, which was performed mechanically in the past, is now performed under electrical control of the skid control ECU, which precisely controls the braking force in accordance with the vehicle's driving conditions.

Front/ Rear Wheels Brake Force Distribution

If the brakes are applied while the vehicle is moving straight forward, the transfer of the road reduces the load that is applied to the rear wheels. The skid control ECU determines this condition by way of the signals from the speed sensor, and the brake actuator regulates the distribution of the brake force of the rear wheels to optimally control.

For example, the amount of the brake force that is applied to the rear wheels during braking varies whether or not the vehicle is carrying a load. The amount of the brake force that is applied to the rear wheels also varies in accordance with the extent of the deceleration.

Thus, the distribution of the brake force to the rear is optimally controlled in order to effectively utilize the braking force of the rear wheels under these conditions.

► EBD Control Concept ◀

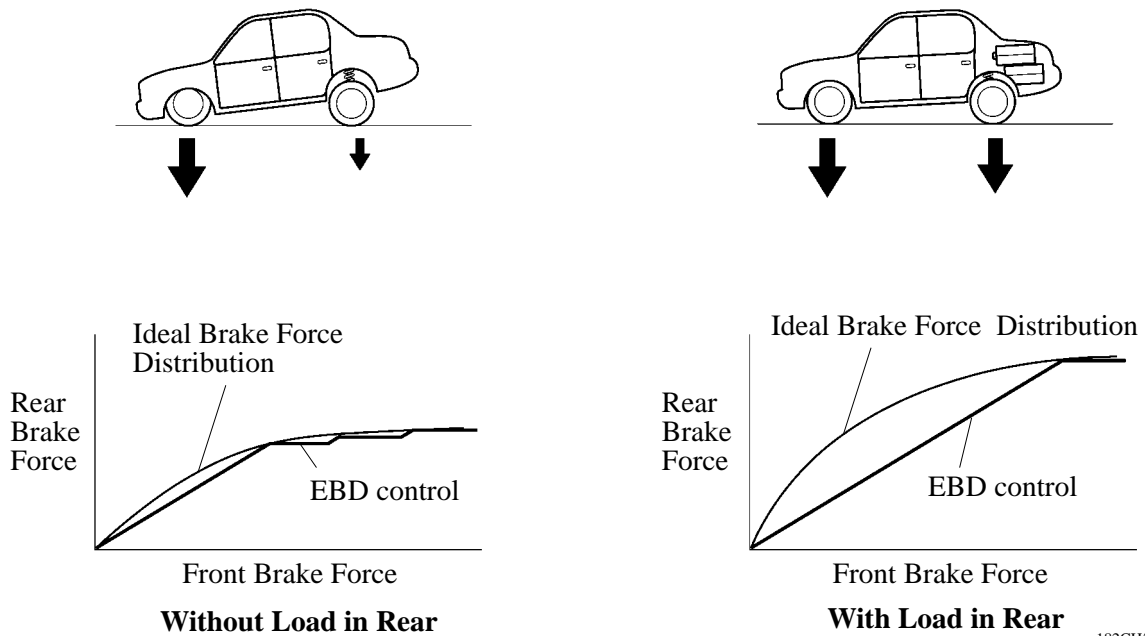

182CH56

Right/Left Wheels Brake Force Distribution (During Cornering Braking)

When the brakes are applied while the vehicle is cornering, the load that applied to the inner wheel decreases to the outer wheel increases.

The skid control ECU determines this condition by way of the signals from the speed sensor, and the brake actuator regulates the brake force in order to optimally control the distribution of the brake force to the inner wheel and outer wheel.

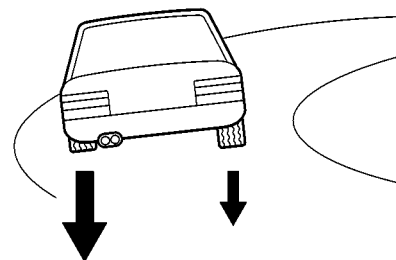

181CH56

4. Outline of Brake Assist System

- The Brake Assist System interprets a quick push of the brake pedal as emergency braking and supplements the braking power applied if the driver has not stepped hard enough on the brake pedal. In emergencies, drivers, especially inexperienced ones, often panic and do not apply sufficient pressure on the brake pedal. Based on the signals from the master cylinder pressure sensors and the brake pedal stroke sensor, the skid control ECU calculates the speed and the amount of the brake pedal application and then determines the intention of the driver to make an emergency braking. If the skid control ECU determines that the driver intends emergency braking, the system activates the brake actuator to increase the brake fluid pressure. The Brake Assist System in combination with ABS helps ensure the vehicle's brake performance. A key feature of Brake Assist system is that the timing and the degree of braking assistance are designed to ensure that the driver does not discern anything unusual about the braking operation. When the driver intentionally eases up on the brake pedal, the system reduces the amount of assistance it provides.
- In case that the vehicle is fully loaded, stronger brake force may be required even if the brakes are not applied quickly. Then, the brake assist system also operates to increase brake force.

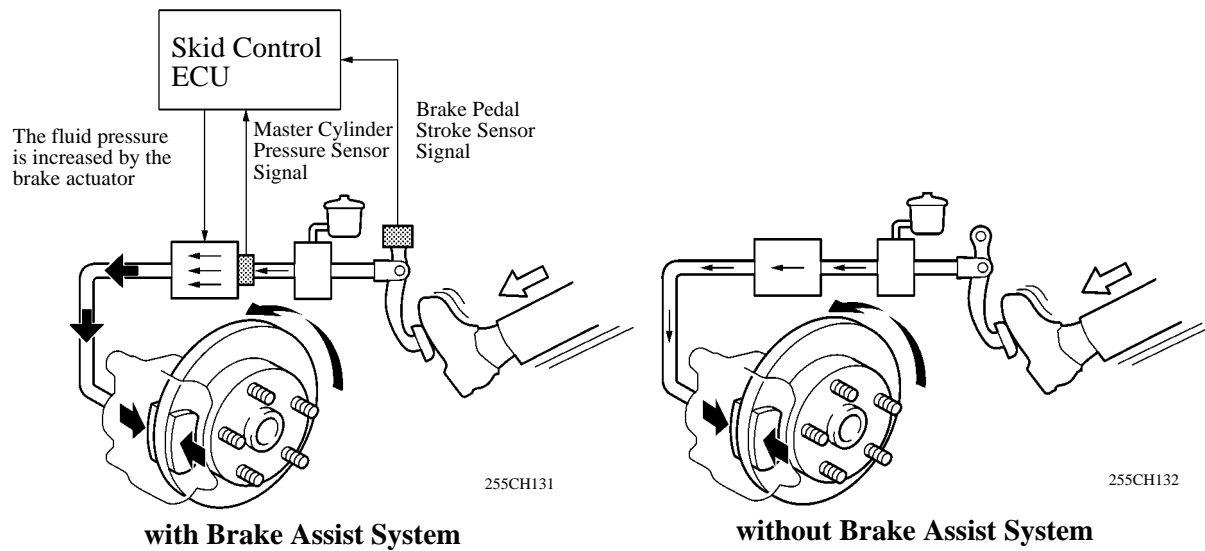

◆: There is no difference of the maximum brake performance between the vehicles with and without brake assist system.

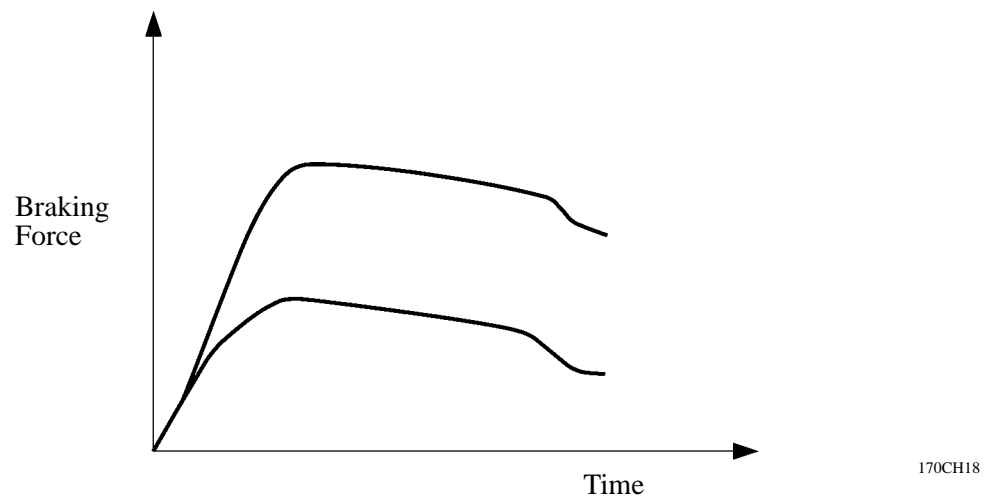

5. Outline of Enhanced VSC System

General

The followings are two examples that can be considered as circumstances in which the tires exceed their lateral grip limit.

The Enhanced VSC system is designed to help control the vehicle behavior by controlling the motive force and the brakes at each wheel when the vehicle is under one of the conditions indicated below.

- When the front wheels lose grip in relation to the rear wheels (front wheel skid tendency).
- When the rear wheels lose grip in relation to the front wheels (rear wheel skid tendency).

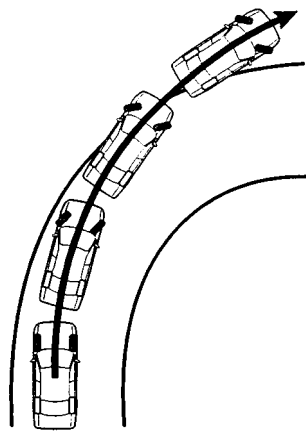

151CH17

Front Wheel Skid Tendency

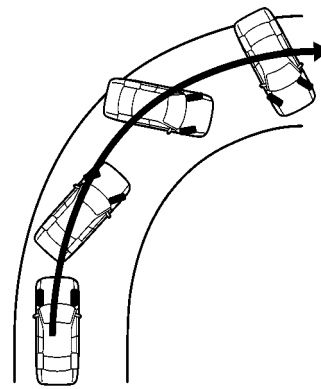

189CH100

Rear Wheel Skid Tendency

Method for Determining the Vehicle Condition

To determine the condition of the vehicle, sensors detect the steering angle, vehicle speed, vehicle's yaw rate, and the vehicle's lateral acceleration, which are then calculated by the skid control ECU.

1) Determining Front Wheel Skid

Whether or not the vehicle is in the state of front wheel skid is determined by the difference between the target yaw rate and the vehicle's actual yaw rate.

When the vehicle's actual yaw rate is smaller than the yaw rate (a target yaw rate that is determined by the vehicle speed and steering angle) that should be rightfully generated when the driver operates the steering wheel, it means the vehicle is making a turn at a greater angle than the locus of travel.

Thus, the skid control ECU determines that there is a large tendency to front wheel skid.

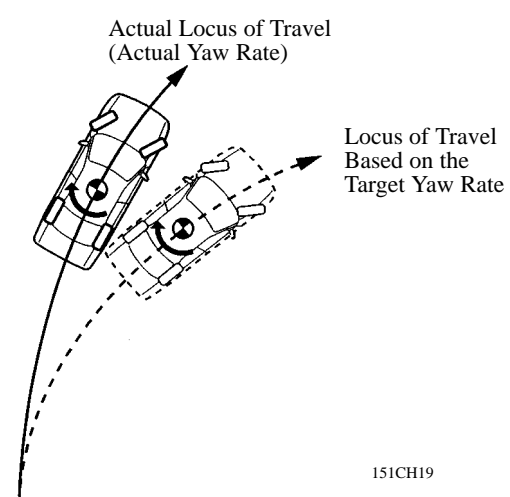

151CH19

2) Determining Rear Wheel Skid

Whether or not the vehicle is in the state of rear wheel skid is determined by the values of the vehicle's slip angle and the vehicle's slip angular velocity (time-dependent changes in the vehicle's slip angle). When the vehicle's slip angle is large, and the slip angular velocity is also large, the skid control ECU determines that the vehicle has a large rear wheel skid tendency.

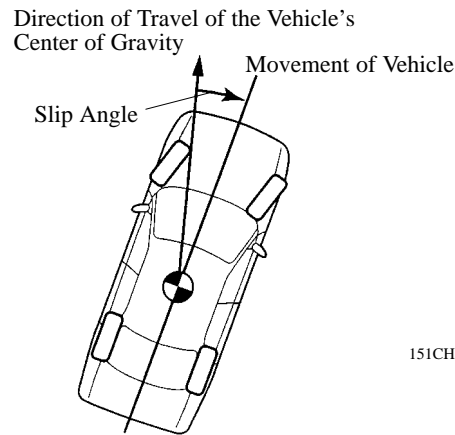

151CH18

Method for Enhanced VSC Operation

When the skid control ECU determines that the vehicle exhibits a tendency to front wheel skid or rear wheel skid, it decreases the engine output and applies the brake of a front or rear wheel to control the vehicle's yaw moment.

The basic operation of the Enhanced VSC is described below. However, the control method differs depending on the vehicle's characteristics and driving conditions.

1) Dampening a Front Wheel Skid

When the skid control ECU determines that there is a large front wheel skid tendency, it counteracts in accordance with the extent of that tendency. The skid control ECU controls the motive power output and applies the brakes of the front wheel of the outer circle in the turns and rear wheels in order to restrain the front wheel skid tendency.

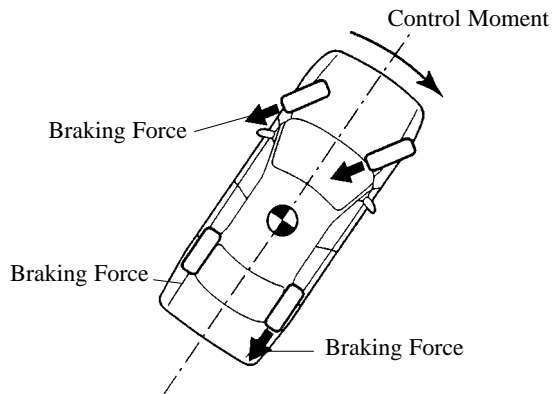

161ES30

Making a Right Turn

2) Dampening a Rear Wheel Skid

When the skid control ECU determines that there is a large rear wheel skid tendency, it counteracts in accordance with the extent of that tendency. It applies the brakes of the front wheel of the outer circle of the turn, and generates an outward moment of inertia in the vehicle, in order to restrain the rear wheel skid tendency. Along with the reduction in the vehicle speed caused by the braking force, the excellent vehicle's stability is ensured.

In some cases, the skid control ECU applies the brake of the rear wheels, as necessary.

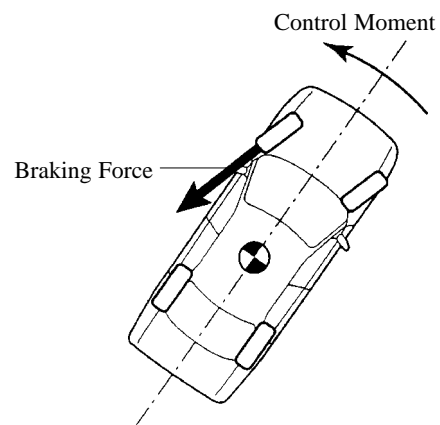

204CH15

Making a Right Turn

Cooperative Control with EPS

Enhanced VSC provides the steering assist in order to facilitate steering operation of the driver depending on vehicle situations by coordination of cooperative control with EPS, in addition to the general VSC control.

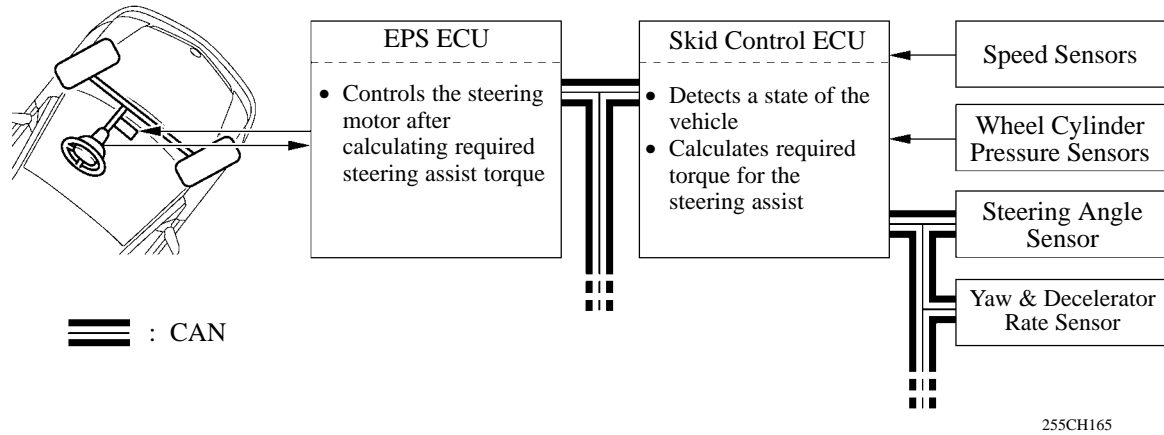

Operation in a wheel skid tendency

- When the rear wheels lose grip, this system control the brake force and the motive force. At the same time, the system controls the steering torque to facilitate the steering effort of the driver.
- When the front wheels exhibit the tendency to skid, the driver could turn the steering wheel excessively, which could worsen the situation. To prevent this, Enhanced VSC provides steering torque assist.

Operation in braking when surface resistance differs to both sides of the wheels

If the vehicle is braking while its right and left wheels are on surfaces with a different resistance, a difference will be created in the braking force applied to the right and left wheels, depending on the strength of the braking force. This will generate a yaw moment, which could require a steering maneuver. In this situation, S-VSC can effect cooperative control jointly with the EPS ECU, and provide a steering torque assist in the direction to cancel out the generated moment. By operating the EPS in this manner and facilitating the steering effort of the driver, Enhanced VSC helps to make the vehicle stable.

