

DTC	P2A00	A/F SENSOR CIRCUIT SLOW RESPONSE (BANK 1 SENSOR 1)
------------	--------------	---

CIRCUIT DESCRIPTION

Refer to DTC P2195 on page [05-314](#).

DTC No.	DTC Detection Condition	Trouble Area
P2A00	When A/F sensor output voltage change is below compared to fuel trim change, ECM judges that A/F sensor circuit response is slow if conditions (a), (b) and (c) are met (2 trip detection logic): (a) After engine is warmed up (b) Engine speed is 1,100 rpm or more (c) Vehicle speed 37.5 mph (60 km/h) or more	<ul style="list-style-type: none"> • Open or short in A/F sensor (bank 1 sensor 1) circuit • A/F sensor (bank 1 sensor 1) • A/F sensor heater • EFI M relay • A/F sensor heater and relay circuit • Air induction system • Fuel pressure • Injector • PCV hose connection • ECM

HINT:

Sensor 1 refers to the sensor mounted before the TWC and is located near the engine assembly.

MONITOR DESCRIPTION

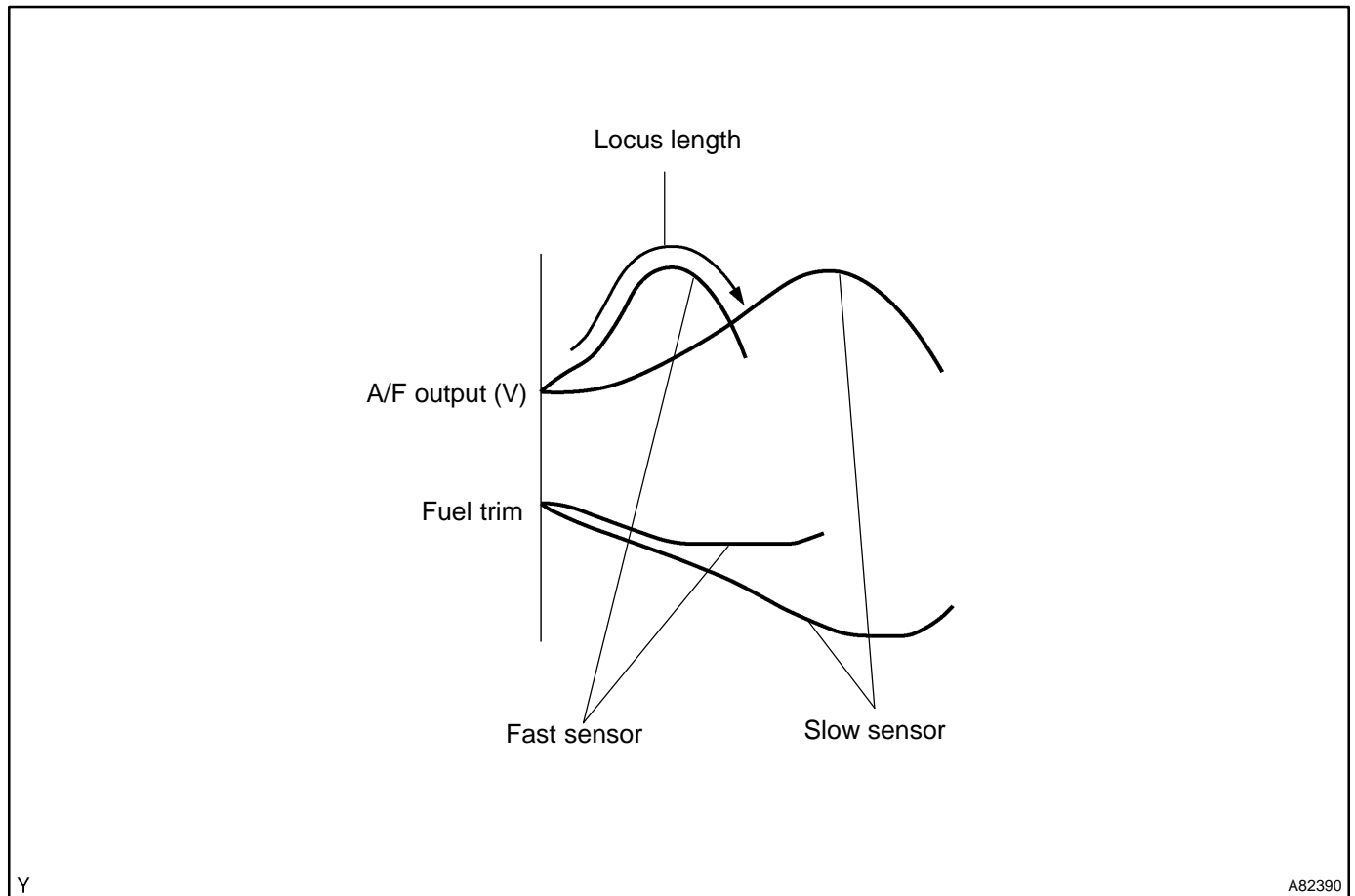

The air fuel-ratio (A/F) sensor varies its output voltage in proportion to the air-fuel ratio. Based on the output voltage, the ECM determines if the air-fuel ratio is RICH or LEAN and adjusts the stoichiometric air-fuel ratio. The ECM also checks the fuel injection volume compensation value to check if the A/F sensor is deteriorating or not. The output voltage variation, known as locus length, should be high when the air-fuel ratio fluctuates. When the A/F sensor response rate has deteriorated, the locus length should be short.

The ECM concludes that there is malfunction in the A/F sensor when the locus length is short and the response rate has deteriorated.

MONITOR STRATEGY

Related DTCs	P2A00: A/F sensor circuit slow response
Required sensors/components	Main: A/F sensor Related: Engine speed sensor, vehicle speed sensor
Frequency of operation	Once per driving cycle
Duration	40 seconds
MIL operation	2 driving cycles
Sequence of operation	None

TYPICAL ENABLING CONDITIONS

The monitor will run whenever the following DTCs are not present	See page 05-20
Engine	Running
Time after first engine start	120 seconds
Fuel system status	Closed-loop
A/F sensor status	Activated
Idle	OFF
Time after idle off	2 seconds
Engine speed	1,100 rpm or more, and 3,400 rpm or less
Vehicle speed	37.5 mph (60 km/h) or more, and 75 mph (120 km/h) or less
Fuel cut	OFF
Time after fuel cut is off	3 seconds or more

TYPICAL MALFUNCTION THRESHOLDS

Response rate deterioration level	8 or more
-----------------------------------	-----------

COMPONENT OPERATING RANGE

Heated oxygen sensor heater current	0.4 to 1.0 A (during idling and battery voltage 11 to 14 V)
-------------------------------------	---

MONITOR RESULT (MODE 06 DATA)

A/F sensor deterioration:

Test ID/Comp ID	Description of Test Data	Description of Test Limit	Conversion Factor (Unit)
\$06/\$81	The ratio of fuel trim locus length to A/F sensor locus length	Malfunction threshold of the ratio of fuel trim locus length to A/F sensor locus length to detect response rate deterioration level	Multiply by 0.000244 (No dimension)

Refer to page [05-26](#) for detailed information on Checking Monitor Status.

WIRING DIAGRAM

Refer to DTC P2195 on page [05-314](#).

INSPECTION PROCEDURE

HINT:

Malfunctioning areas can be found by performing the ACTIVE TEST / A/F CONTROL operation. The A/F CONTROL operation can determine if the A/F sensor, heated oxygen sensor or other potential trouble area are malfunctioning or not.

(a) Perform the ACTIVE TEST A/F CONTROL operation.

HINT:

The A/F CONTROL operation lowers the injection volume 12.5% or increases the injection volume 25%.

- (1) Connect the hand-held tester to the DLC3 on the vehicle.
- (2) Turn the power switch ON (IG).
- (3) Put the engine in inspection mode (see page 05-1).
- (4) Warm up the engine by running the engine at 2,500 rpm with the accelerator pedal depressed more than 60 % for approximately 90 seconds.
- (5) Select the item: DIAGNOSIS / ENHANCED OBD II / ENGINE AND ECT / ACTIVE TEST / A/F CONTROL.
- (6) Perform the A/F CONTROL operation with the engine in an idle condition (press the right or left button).

Result:

A/F sensor reacts in accordance with increase and decrease of injection volume:

+25 % → rich output: Less than 3.0 V

-12.5 % → lean output: More than 3.35 V



Heated oxygen sensor reacts in accordance with increase and decrease of injection volume:

+25 % → rich output: More than 0.55 V

-12.5 % → lean output: Less than 0.4 V

NOTICE:

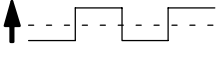
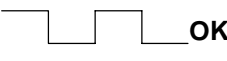
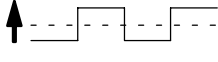
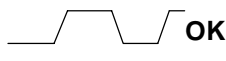
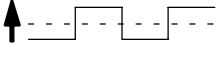
The A/F sensor output has a few seconds of delay and the heated oxygen sensor output has about 20 seconds of delay at maximum.

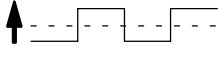
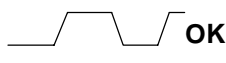
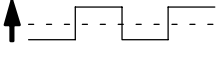
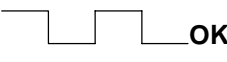
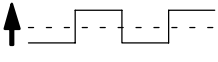
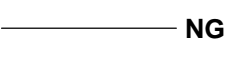
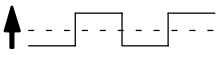
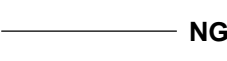
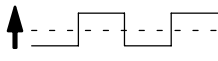
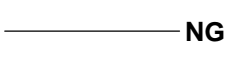
	Output voltage of A/F sensor (sensor 1)	Output voltage of heated oxygen sensor (sensor 2)	Main Suspect Trouble Area
Case 1	Injection volume +25 %  -12.5 % Output voltage More than 3.35 V  OK Less than 3.0 V	Injection volume +25 %  -12.5 % Output voltage More than 0.55 V  OK Less than 0.4V	—
Case 2	Injection volume +25 %  -12.5 % Output voltage Almost no reaction  NG	Injection volume +25 %  -12.5 % Output voltage More than 0.55 V  OK Less than 0.4V	A/F sensor (A/F sensor, sensor heater, sensor circuit)
Case 3	Injection volume +25 %  -12.5 % Output voltage More than 3.35 V  OK Less than 3.0V	Injection volume +25 %  -12.5 % Output voltage Almost no reaction  NG	Heated oxygen sensor (heated oxygen sensor, sensor heater, sensor circuit)
Case 4	Injection volume +25 %  -12.5 % Output voltage Almost no reaction  NG	Injection volume +25 %  -12.5 % Output voltage Almost no reaction  NG	Extremely RICH or LEAN actual air-fuel ratio (Injector, fuel pressure, gas leakage in exhaust system, etc.)

The following A/F CONTROL procedure enables the technician to check and graph the voltage output of both A/F sensor and heated oxygen sensor.

To display the graph, enter ACTIVE TEST / A/F CONTROL / USER DATA, select "AFS B1S1 and O2S B1S2" by pressing the "YES" button followed by the "ENTER" button and then the "F4" button.

- DTC P2A00 may be also detected, when the air-fuel ratio stays RICH or LEAN.
- Read freeze frame data using the hand-held tester or the OBD II scan tool. Freeze frame data records the engine condition when malfunction is detected. When troubleshooting, freeze frame data can help determine if the vehicle was running or stopped, if the engine was warmed up or not, if the air-fuel ratio was lean or rich, and other data from the time the malfunction occurred.
- A high A/F sensor voltage could be caused by a RICH air-fuel mixture. Check the conditions that would cause the engine to run with the RICH air-fuel mixture.
- A low A/F sensor voltage could be caused by a LEAN air-fuel mixture. Check the conditions that would cause the engine to run with the LEAN air-fuel mixture.

1	CHECK OTHER DTC OUTPUT(IN ADDITION TO A/F SENSOR DTC)
----------	--

- (a) Connect the hand-held tester or the OBD II scan tool to the DLC3.
- (b) Turn the power switch ON (IG).
- (c) Turn the hand-held tester or the OBD II scan tool ON.
- (d) On the hand-held tester, select the item: DIAGNOSIS / ENHANCED OBD II / ENGINE AND ECT / DTC INFO / CURRENT CODES.
- (e) Read DTCs using the hand-held tester or the OBD II scan tool.

Result :

Display (DTC Output)	Proceed to
P2A00	A
P2A00 and other DTCs	B

HINT:

If any other code besides P2A00 are output, perform troubleshooting for those DTCs first.

B

GO TO RELEVANT DTC CHART (See page 05-55)
--

A

2	READ VALUE OF OBD II SCAN TOOL OR HAND-HELD TESTER(OUTPUT VOLTAGE OF A/F SENSOR)
----------	---

- (a) Connect the hand-held tester or the OBD II scan tool to the DLC 3.
- (b) Put the engine in inspection mode (see page [05-1](#)).
- (c) Warm up the A/F sensors (bank 1 sensor 1) by running the engine at 2,500 rpm, depressing the accelerator pedal more than 60 % for approximately 90 seconds.
- (d) Read A/F sensor voltage output on the OBD II scan tool or the hand-held tester.
- (e) Hand-held tester only:
On the hand-held tester, enter the menus: ENHANCED OBD II / ENGINE AND ECT / SNAPSHOT / MANUAL SNAPSHOT / USER DATA.
- (f) Select "AFS B1 S1/ENGINE SPD" and press button "YES".
- (g) Monitor the A/F sensor voltage carefully.
- (h) Check the A/F sensor voltage output under the following conditions:
 - (1) Put the engine in inspection mode and allow the engine to idle for 30 seconds.
 - (2) Put the engine in inspection mode and running the engine at 2,500 rpm with the accelerator pedal depressed more than 60 % (where engine RPM is not suddenly changed).
 - (3) Deactivate the inspection mode and drive the vehicle with shift position "B" range.
 - (4) Accelerate the vehicle to 44 mph (70 km/h) and quickly release the accelerator pedal so that the throttle valve fully close.

CAUTION:

- **Strictly observe of posted speed limits, traffic laws, and road conditions when performing these drive patterns.**
- **Do not drive the vehicle without deactivating inspection mode, otherwise damaging the trans-axle may result.**

Standard:**Condition (1) and (2)**

Voltage changes in the vicinity of 3.3 V (0.66 V)* (between approximately 3.1 to 3.5 V) as shown in the illustration.

Condition (4)

A/F sensor voltage increases to 3.8 V (0.76 V)* or more during engine deceleration (when fuel cut) as shown in the illustration.

*: Voltage when using the OBD II scan tool.

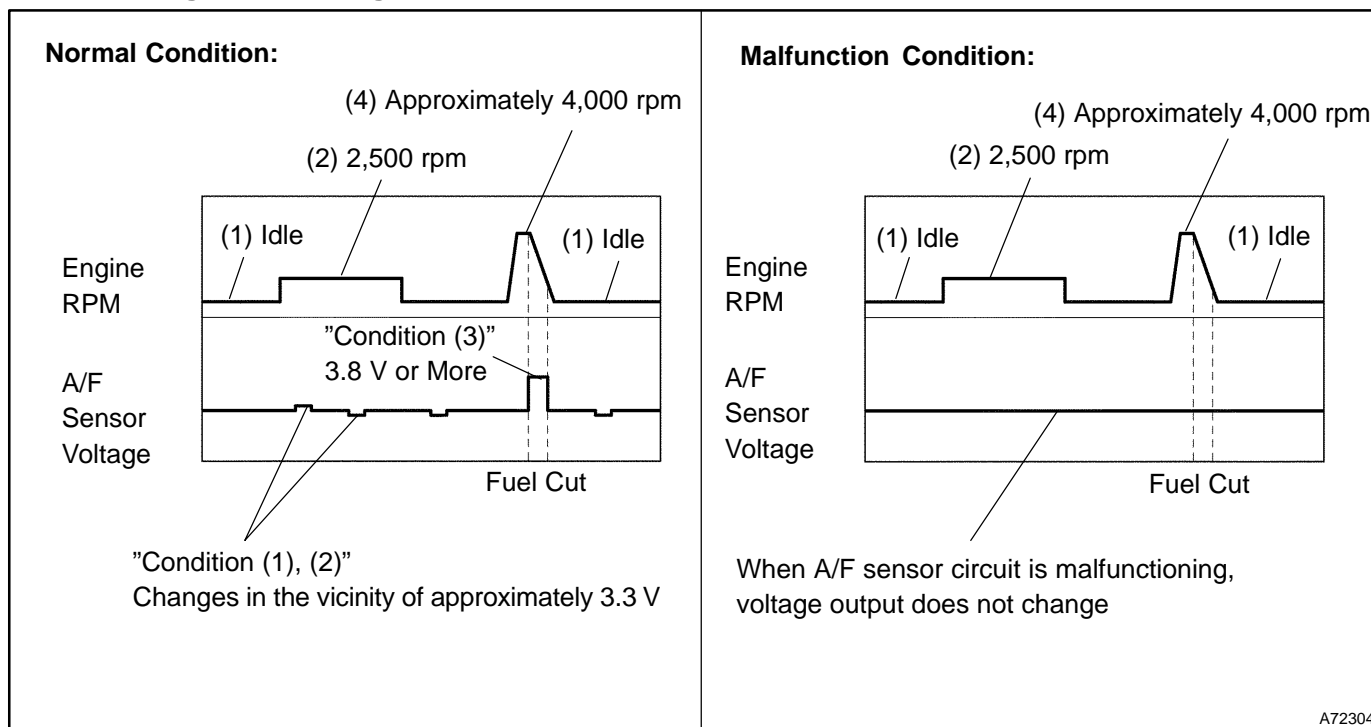

A72304

HINT:

- Whenever the output voltage of the A/F sensor remains at approximately 3.3 V (0.660 V)* (see diagram Malfunction Condition) under any condition as well as the above conditions, the A/F sensor may have an open-circuit. (This will happen also when the A/F sensor heater has an open-circuit.)
- Whenever the output voltage of the A/F sensor remains at a certain value of approximately 3.8 V (0.76 V)* or more, or 2.8 V (0.56 V)* or less (see diagram Malfunction Condition) under any condition as well as the above conditions, the A/F sensor may have a short-circuit.
- The ECM will stop fuel injection (fuel cut) during engine deceleration. This will cause a LEAN condition and should result in a momentary increase in A/F sensor voltage output.
- The ECM must establish a closed throttle position learned value to perform fuel cut. If the battery terminal was reconnected, the vehicle must be driven over 10 mph (16 km/h) to allow the ECM to learn the closed throttle position.
- When the vehicle is driven:
The output voltage of the A/F sensor may be below 2.8 V (0.76 V)* during fuel enrichment. For the vehicle, this translates to a sudden increase in speeds with the accelerator pedal fully depressed when trying to overtake another vehicle. The A/F sensor is functioning normally.
- The A/F sensor is a current output element, and therefore the current is converted into voltage inside the ECM. If measuring voltage at connectors of A/F sensor or ECM, you will observe a constant voltage.

*: Voltage when using the OBD II scan tool.

OK → Go to step 14

NG

3 INSPECT AIR FUEL RATIO SENSOR(RESISTANCE OF A/F SENSOR HEATER)

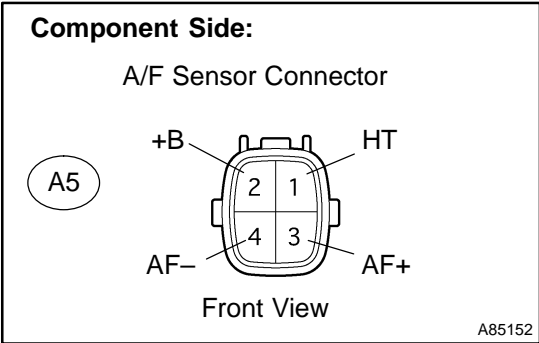

- (a) Disconnect the A5 A/F sensor connector.
- (b) Measure the resistance between the terminals of the A/F sensor.

Standard:

Tester Connection	Resistance
HT (1) – +B (2)	1.8 to 3.4 Ω at 20°C (68°F)

- (c) Reconnect the A/F sensor connector.

NG → REPLACE AIR FUEL RATIO SENSOR

OK

4 INSPECT INTEGRATION RELAY(EFI M RELAY)

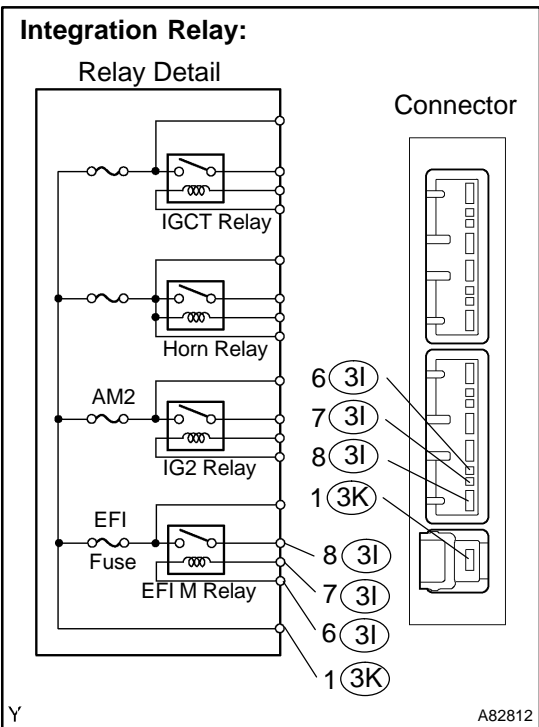

- (a) Remove the integration relay from the engine room R/B.
- (b) Inspect the EFI M relay.

Standard:

Tester Connection	Specified Condition
(3K-1) – (3I-8)	10 kΩ or higher
(3K-1) – (3I-8)	Below 1 Ω (Apply battery voltage to terminals 3I-6 and 3I-7)

- (c) Reinstall the integration relay.

NG → REPLACE INTEGRATION RELAY

OK

5 CHECK HARNESS AND CONNECTOR(A/F SENSOR - ECM)

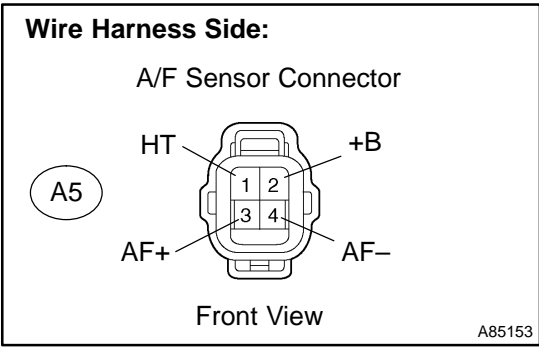

- (a) Disconnect the A5 A/F sensor connector.
- (b) Disconnect the E5 ECM connector.
- (c) Check the resistance between the wire harness side connectors.

Standard (Check for open):

Tester Connection	Specified Condition
AF+ (A5-3) - A1A+ (E5-23)	Below 1 Ω
AF- (A5-4) - A1A- (E5-22)	Below 1 Ω
HT (A5-1) - HA1A (E5-7)	Below 1 Ω

Standard (Check for short):

Tester Connection	Specified Condition
AF+ (A5-3) or A1A+ (E5-23) - Body ground	10 kΩ or higher
AF- (A5-4) or A1A- (E5-22) - Body ground	10 kΩ or higher
HT (A5-1) or HA1A (E5-7) - Body ground	10 kΩ or higher

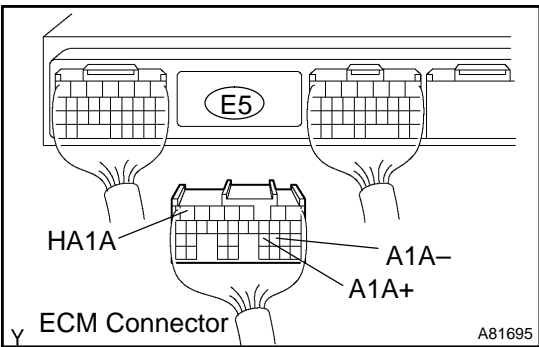

- (d) Reconnect the A/F sensor connector.
- (e) Reconnect the ECM connector.

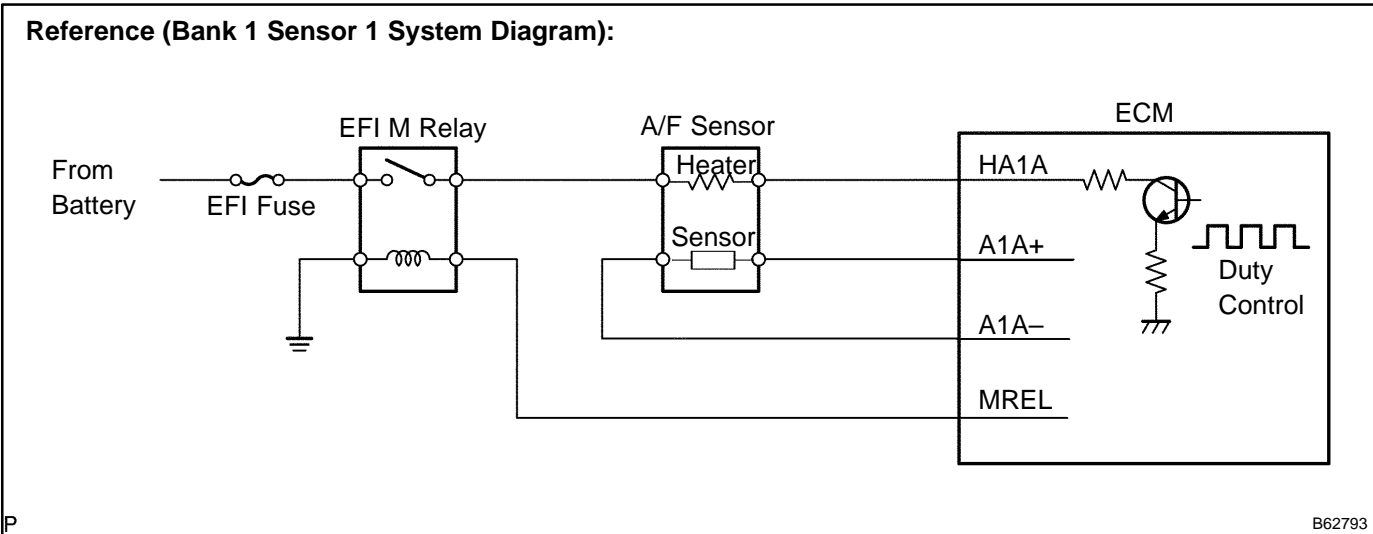

NG REPAIR OR REPLACE HARNESS OR CONNECTOR

OK

6 CHECK AIR INDUCTION SYSTEM

- (a) Check for vacuum leaks in the air induction system.

OK: There is no leakage in the air induction system.

NG

REPAIR OR REPLACE AIR INDUCTION SYSTEM

OK

7 CHECK CONNECTION OF PCV HOSE

OK: PCV hose is connected correctly and PCV hose has no damage.

NG

REPAIR OR REPLACE PCV HOSE

OK

8 CHECK FUEL PRESSURE (See page 11-7)

- (a) Check fuel pressure (high or low fuel pressure).

OK:

Fuel pressure: 304 to 343 kPa (3.1 to 3.5 kgf/cm², 44 to 50 psi)

NG

REPAIR OR REPLACE FUEL SYSTEM

OK

9 INSPECT FUEL INJECTOR ASSY (See page 11-12)

- (a) Check the injector injection (high or low fuel injection quantity or poor injection pattern).

OK:

Injection volume: 36 to 46 cm³ (2.1 to 2.8 cu in.) per 15 seconds.

NG

**REPLACE FUEL INJECTOR ASSY
(See page 11-12)**

OK

10 REPLACE AIR FUEL RATIO SENSOR

GO

11 PERFORM CONFIRMATION DRIVING PATTERN (See page 05-314)

HINT:

Clear all DTCs prior to performing the confirmation driving pattern (see page 05-314).

GO

12 READ OUTPUT DTC(SEE IF A/F SENSOR DTC IS OUTPUT AGAIN)

- (a) Connect the hand-held tester or the OBD II scan tool to the DLC3.
- (b) Turn the power switch ON (IG).
- (c) Turn the hand-held tester or the OBD II scan tool ON.
- (d) On the hand-held tester, select the item: DIAGNOSIS / ENHANCED OBD II / ENGINE AND ECT / DTC INFO / CURRENT CODES.
- (e) Read DTCs using the hand-held tester or the OBD II scan tool.

Result :

Display (DTC output)	Proceed to
No output	A
P2A00 again.	B

B → **REPLACE ECM (See page 10-24) AND PERFORM CONFIRMATION DRIVING PATTERN (See page 05-314)**

A

13 CONFIRM IF VEHICLE HAS RUN OUT OF FUEL IN PAST

OK: Vehicle has run out of the fuel in the past.

NO → **CHECK FOR INTERMITTENT PROBLEMS (See page 05-17)**

YES

DTC IS CAUSED BY RUNNING OUT OF FUEL

14 PERFORM CONFIRMATION DRIVING PATTERN (See page 05-314)

HINT:

Clear all DTCs prior to performing the confirmation driving pattern (see page 05-314).

GO

15 READ OUTPUT DTC(SEE IF A/F SENSOR DTC IS OUTPUT AGAIN)

- (a) Connect the hand-held tester or the OBD II scan tool to the DLC3.
- (b) Turn the power switch ON (IG).
- (c) Turn the hand-held tester or the OBD II scan tool ON.
- (d) On the hand-held tester, select the item: DIAGNOSIS / ENHANCED OBD II / ENGINE AND ECT / DTC INFO / CURRENT CODES.
- (e) Read DTCs using the hand-held tester or the OBD II scan tool.

Result :

Display (DTC output)	Proceed to
P2A00	A
No output	B

B → **Go to step 19**

A

16 REPLACE AIR FUEL RATIO SENSOR

GO

17 PERFORM CONFIRMATION DRIVING PATTERN (See page 05-314)

HINT:

Clear all DTCs prior to performing the confirmation driving pattern (see page 05-314).

GO

18 READ OUTPUT DTC(SEE IF A/F SENSOR DTC IS OUTPUT AGAIN)

- (a) Connect the hand-held tester or the OBD II scan tool to the DLC3.
- (b) Turn the power switch ON (IG).
- (c) Turn the hand-held tester or the OBD II scan tool ON.
- (d) On the hand-held tester, select the item: DIAGNOSIS / ENHANCED OBD II / ENGINE AND ECT / DTC INFO / CURRENT CODES.
- (e) Read DTCs using the hand-held tester or the OBD II scan tool.

Result :

Display (DTC output)	Proceed to
No output	A
P2A00	B

B **REPLACE ECM (See page 10-24) AND PERFORM CONFIRMATION DRIVING PATTERN (See page 05-314)**

A

19 CONFIRM IF VEHICLE HAS RUN OUT OF FUEL IN PAST

OK: Vehicle has run out of the fuel in the past.

NO **CHECK FOR INTERMITTENT PROBLEMS (See page 05-17)**

YES

DTC IS CAUSED BY RUNNING OUT OF FUEL