

54D 電路系統

目錄

中繼盒(J/B).....	54D-3	車門燈	54D-61
中繼接頭.....	54D-5	點火開關照明燈.....	54D-62
繼電器、易熔絲、保險絲	54D-8	方向燈及危險警告燈	54D-64
電源分配系統.....	54D-14	角燈.....	54D-68
起動系統.....	54D-22	剎車燈	54D-71
點火系統.....	54D-23	倒車燈	54D-72
充電系統.....	54D-24	喇叭.....	54D-73
引擎控制系統.....	54D-26	儀錶.....	54D-74
冷卻系統.....	54D-35	警告燈	54D-76
INVECS-II 4A/T	54D-36	電動窗	54D-78
頭燈	54D-46	中控鎖及防盜系統	54D-84
手套箱	54D-49	手動空調除霧系統	54D-91
尾燈/位置燈/牌照燈.....	54D-50	手動空調系統	54D-92
霧燈.....	54D-54	自動空調系統	54D-98
室內燈/行李廂燈.....	54D-58	前擋風玻璃雨刷及噴水器	54D-108

後擋風玻璃雨刷及噴水器	54D-114	鑰匙未取出蜂鳴器	54D-138
電動摺疊式遙控後視鏡	54D-118	點煙器	54D-140
自動空調除霧	54D-122	第二電源插座	54D-141
SRS	54D-124	天窗	54D-142
防鎖死剎車系統(ABS)	54D-126	倒車雷達	54D-143
電動護腰器	54D-131	化妝鏡燈	54D-144
電動座椅	54D-132	音響/VCD	54D-145
儀錶燈光亮度調整器	54D-134	行動通訊系統	54D-150
燈光監視蜂鳴器	54D-136		

中繼盒 (J/B)

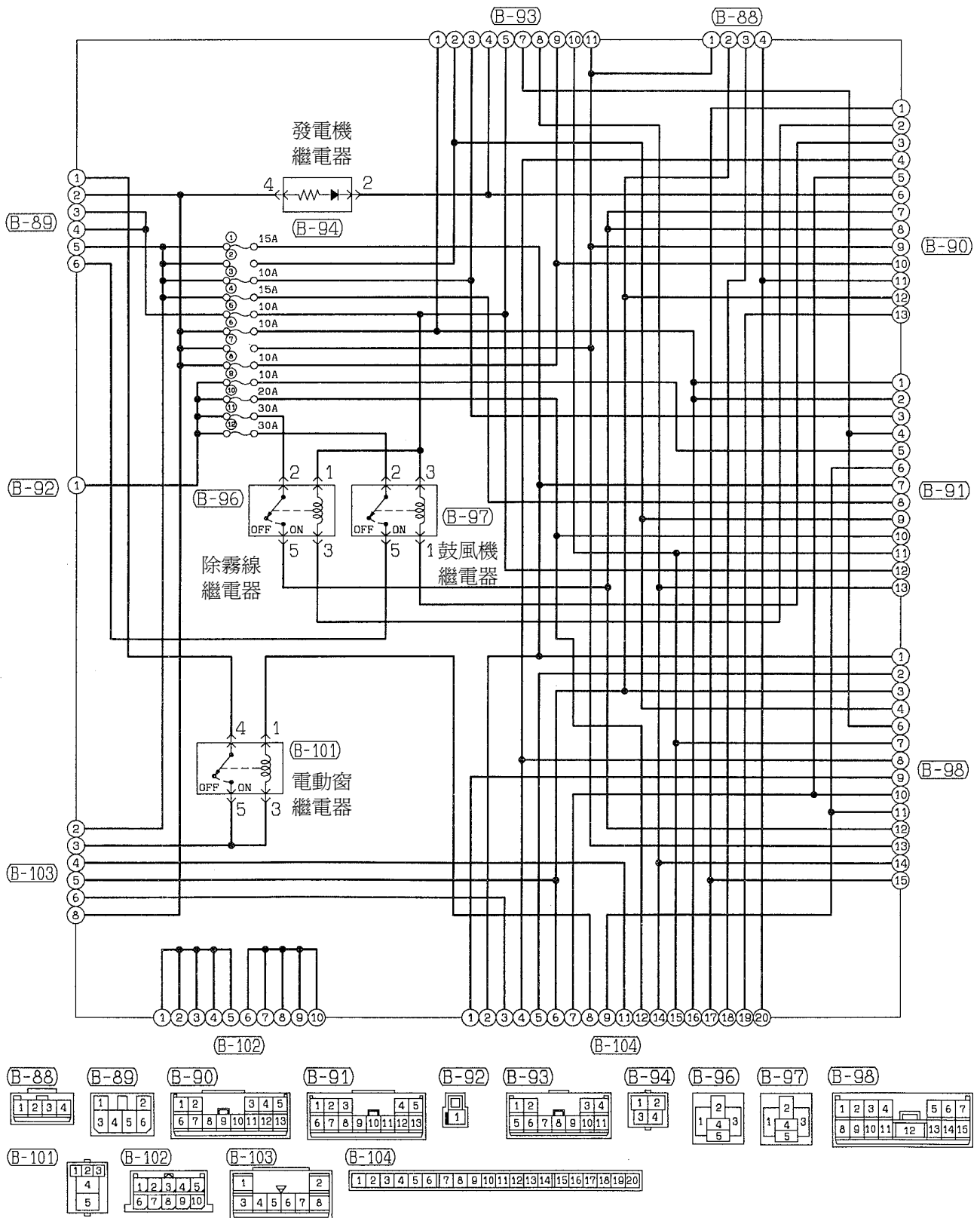

中繼盒 (J/B)

正面

背面

接儀錶板電線束

接儀錶板電線束

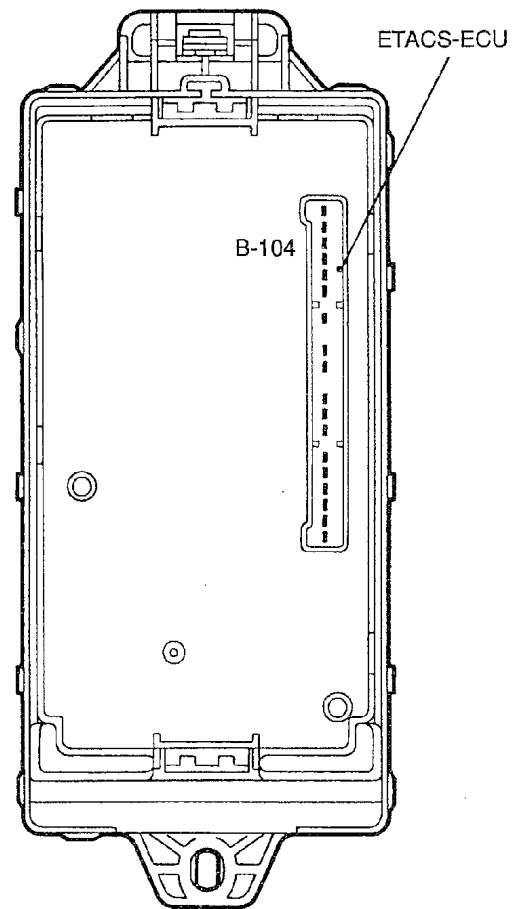
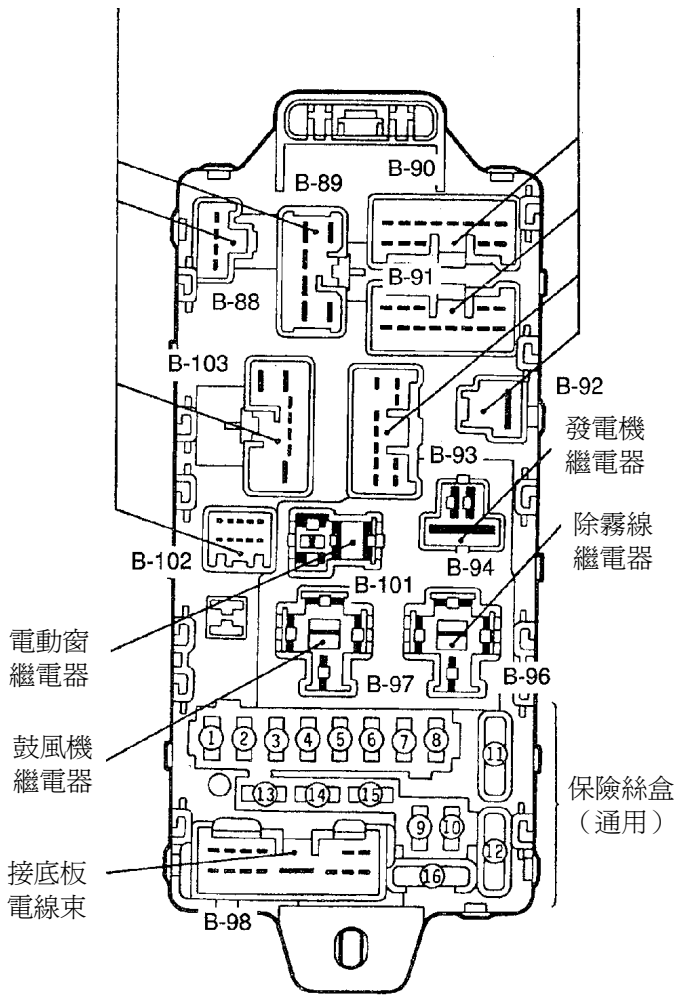

中繼接頭 (J/C)

J/C (1)

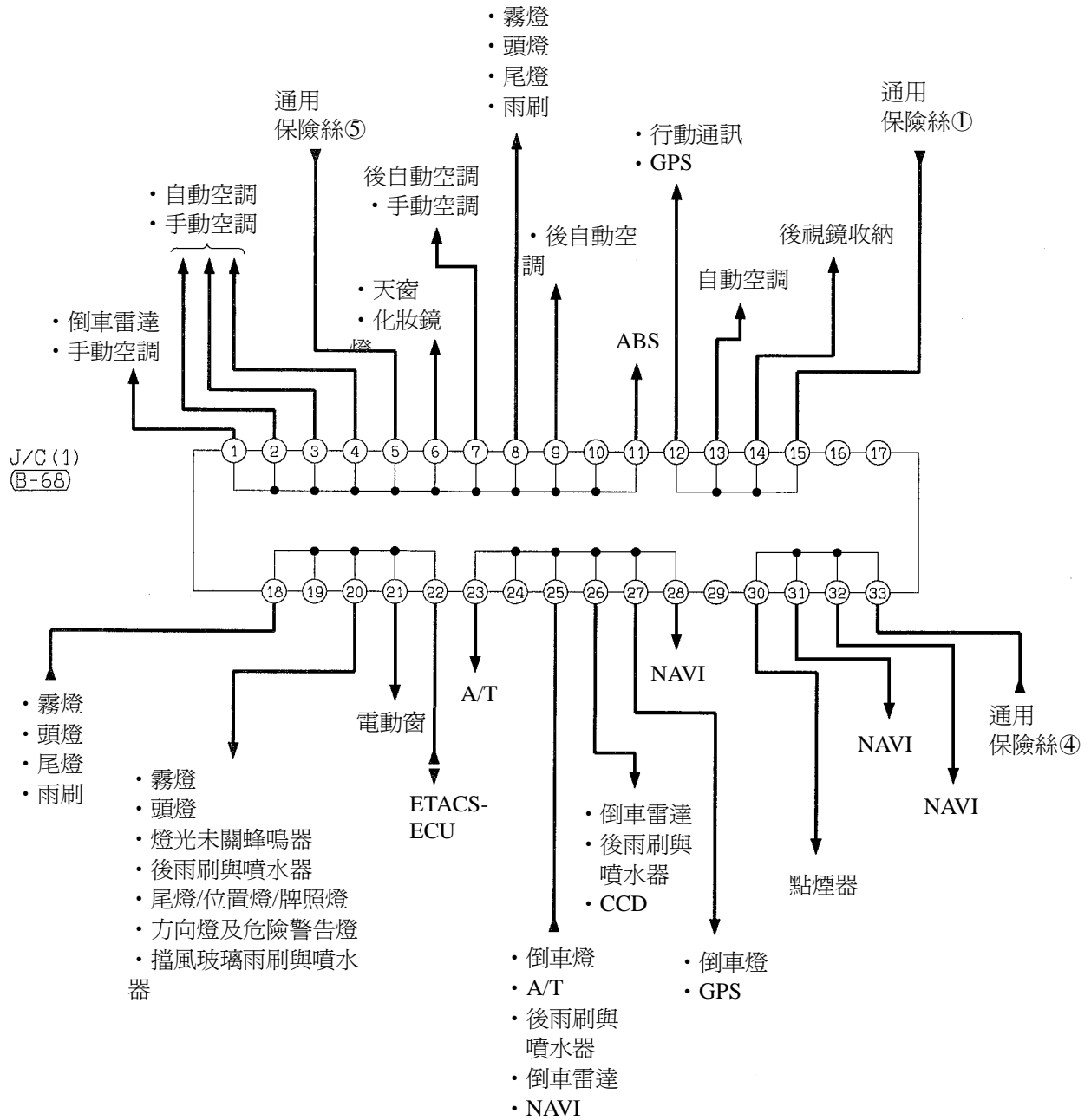

(B-44)

1	2	3	4	5	6	7	8	9	10	11
12	13	14	15	16	17	18	19	20	21	22
23	24	25	26	27	28	29	30	31	32	33

(B-68)

1	2	3	4	5	6	7	8	9	10	11
12	13	14	15	16	17	18	19	20	21	22
23	24	25	26	27	28	29	30	31	32	33

中繼接頭 (J/C)

J/C (2)

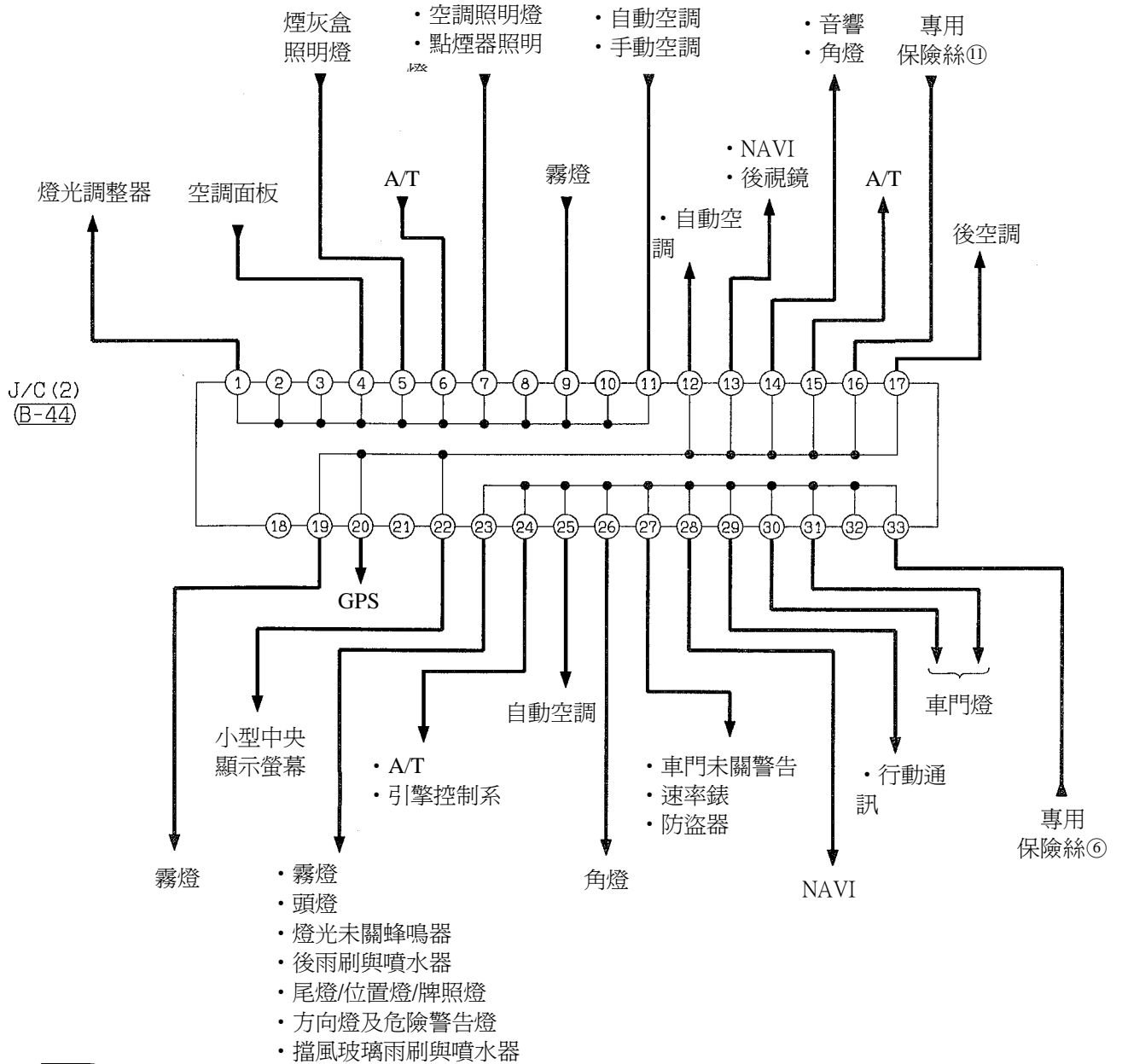

(B-44)

1	2	3	4	5	6	7	8	9	10	11
12	13	14	15	16	17	18	19	20	21	22
23	24	25	26	27	28	29	30	31	32	33

中繼接頭 (J/C)

J/C (3)

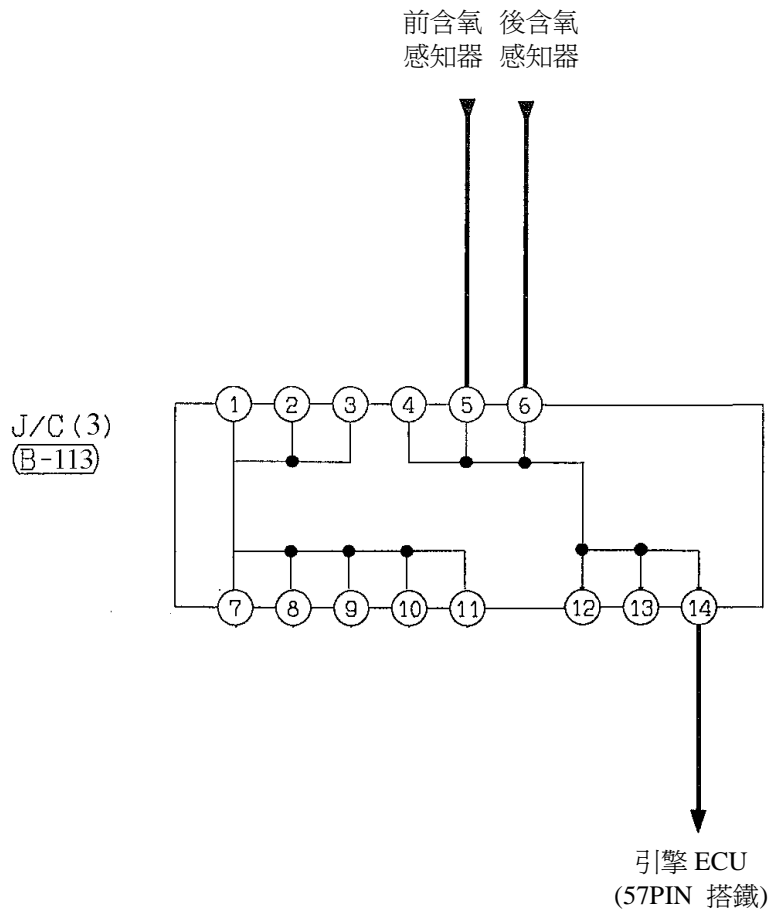

B-113

1	2	3	▽	4	5	6	
7	8	9	10	11	12	13	14

54D-8 DZL 迴路圖－引擎室內繼電器盒

引擎室內繼電器盒

接頭號碼	名稱	接頭號碼	名稱
A-12X	A/T 控制繼電器	A-19X	—
A-13X	—	A-20X	風扇控制繼電器
A-14X	引擎控制繼電器	A-21X	—
A-15X	燃油泵繼電器	A-22X	喇叭繼電器
A-16X	後空調繼電器	A-23X	霧燈繼電器
A-17X	A/C 壓縮機繼電器	A-24X	前-ECU
A-18X	檢查接頭	A-25X	前-ECU

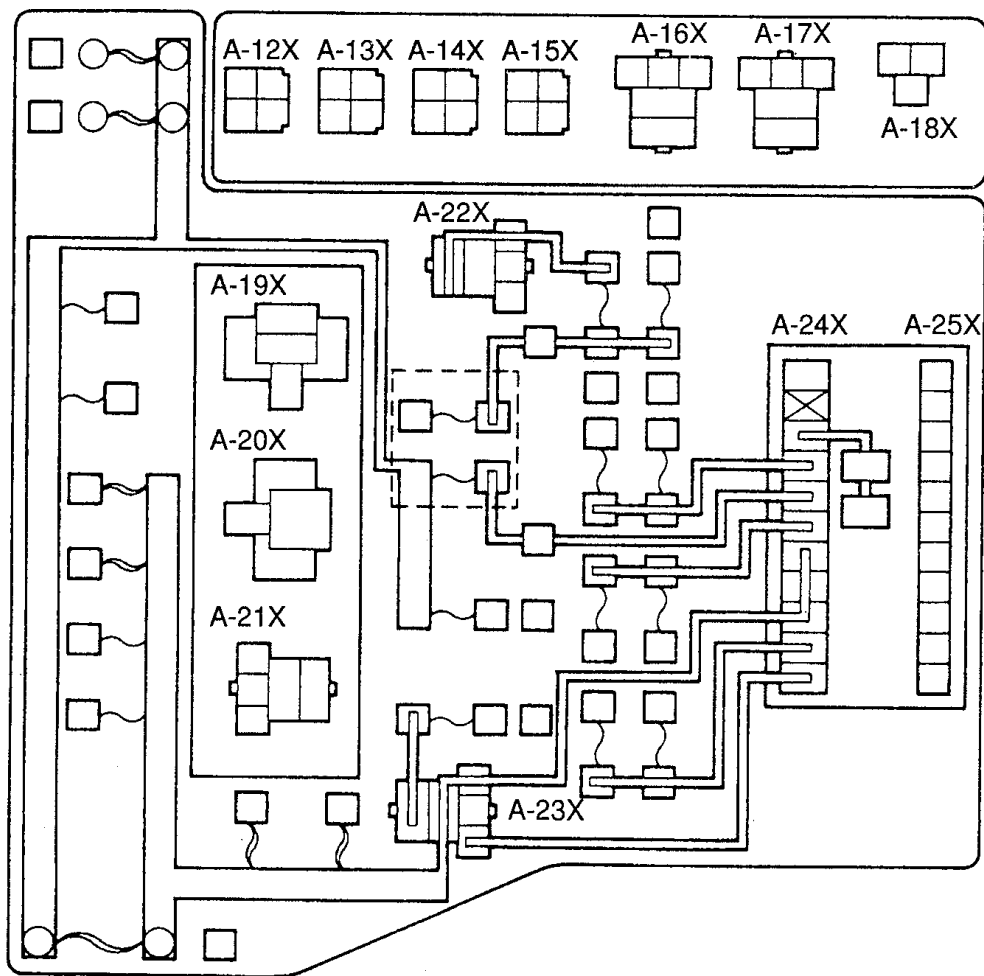

易熔絲

(位於引擎室內之繼電器盒)

NO	使用迴路	外殼顏色	額定容量 (A)
1	ABS 迴路	黃	60
2	通用保險絲 NO.9,10,11,12 及專用保險絲 NO.20 迴路	黃	60
3	A/T 及引擎控制系統	淺藍	20
4	點火開關迴路	粉紅	30
5	充電系統, 專用保險絲 NO.1,2,6,7 及易熔絲 NO.1,2 迴路	藍	100
6	專用保險絲 NO.17,18 及電動窗迴路	綠	40
7	風扇控制迴路	紅	50

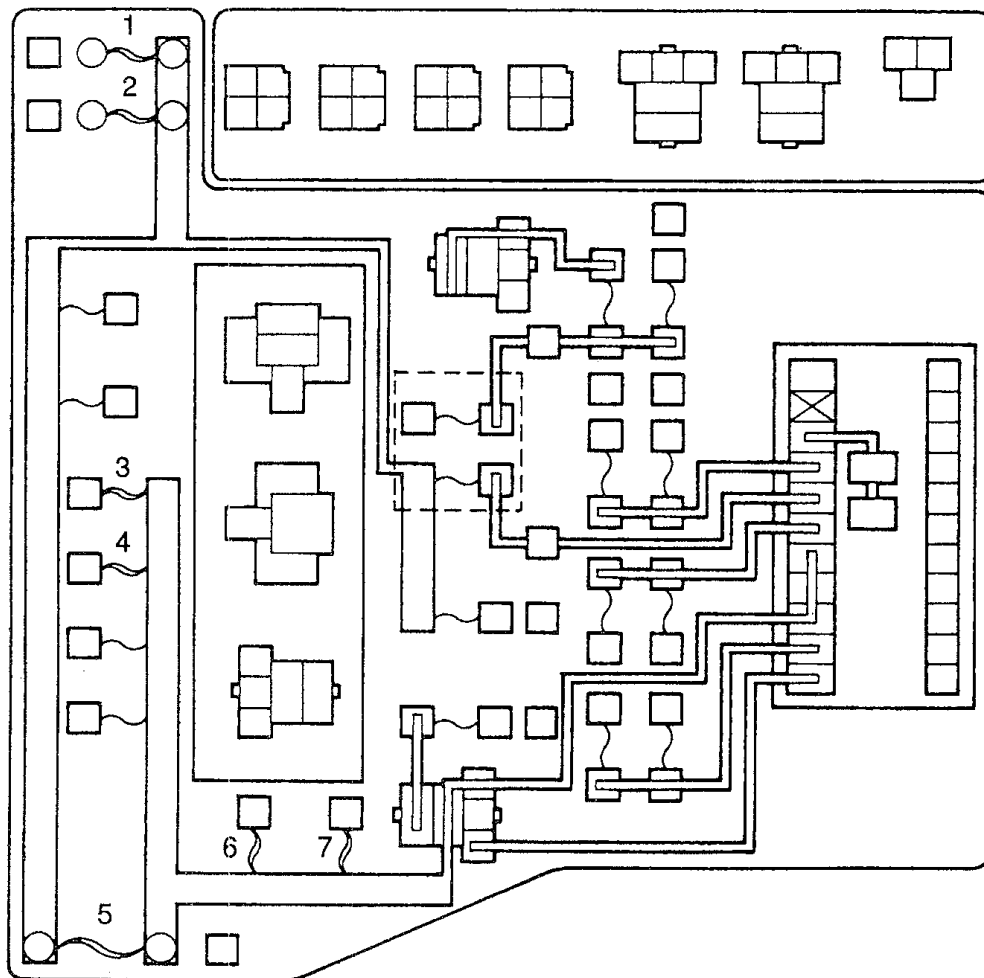

專用保險絲

電源供應迴路	NO	額定容量	外殼	使用迴路/負載
發電機 (易熔絲)	1	15	藍	DC 電源第二插座迴路
	2	20	黃	遙控中控、電動座椅、NAVI
電瓶/發電機 (易熔絲)	3	10	紅	發電機、危險警告燈、防盜器、方向燈迴
	4	15	藍	剎車燈迴路
點火開關 ACC	5	10	紅	DC 電源第二插座、小型中央顯示螢幕、音響迴路
發電機 (易熔絲 NO.5)	6	10	紅	A/C-ECU、電子鐘、柱開關電源供應、車門燈、ETACS-ECU、引擎-A/T-ECU、前-ECU、行李箱燈、音響、室內燈、速率錶、天窗-ECU、轉速錶迴路
	7	10	紅	A/C 壓縮機迴路
霧燈繼電器	8	20	黃	霧燈迴路
點火開關 ACC	9	10	紅	喇叭迴路
	10	20	黃	擋風玻璃雨刷與噴水器迴路
電瓶/發電機 (易熔絲 NO.5)	11	10	紅	儀錶燈、燈光調整器、尾燈迴路
	12	10	紅	尾燈迴路
	13	10	紅	頭燈迴路
	14	10	紅	
	15	10	紅	
	16	10	紅	
電瓶/發電機 (易熔絲 NO.5)	17	20	黃	G-NET
	18	20	黃	天窗迴路 (易熔絲 NO.6)
	19	10	紅	後視鏡除霧迴路 (易熔絲 NO.2)
	20	20	黃	後 A/C 迴路 (易熔絲 NO.2)
	21	10	紅	遙控中控、NAVI
	22	20	黃	電動座椅

專用保險絲

位於引擎室內之繼電器盒

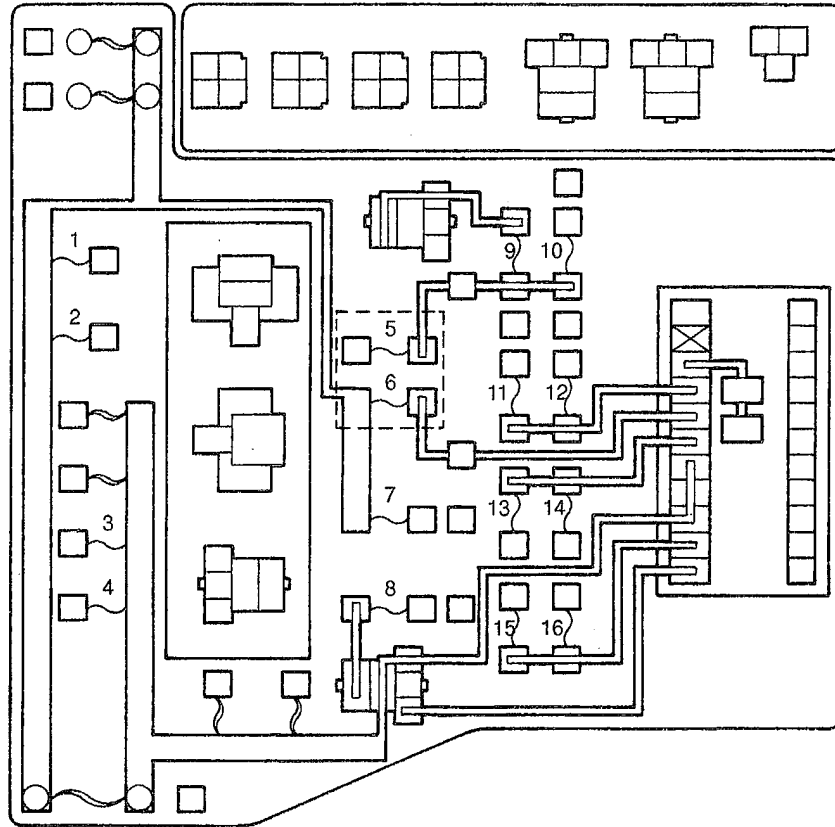

位於中繼盒 (J/B)

保險絲座 A

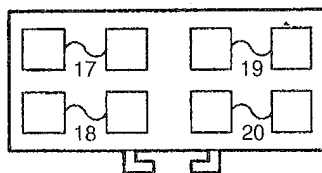

保險絲座 B

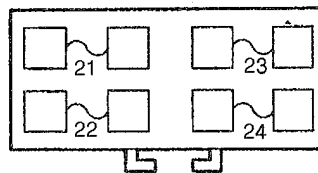

通用保險絲

位於中繼盒 (J/B)

電源供應迴路		NO	額定容量 (A)	外殼 顏色	使用迴路/負載	
點火開關	ACC	1	15	藍	A/C-ECU、ETACS-ECU、後雨刷馬達、後視鏡	
		2	—	—	—	
		3	—	—	—	
		4	15	藍	點煙器	
	IG2	5	10	紅	ABS-ECU、ABS 警告燈繼電器、A/C 壓縮機繼電器、鼓風機繼電器、鼓風機開關、除霧線繼電器、前-ECU、內外氣循環控制馬達、後 A/C 繼電器、天窗-ECU、化妝鏡燈	
		IG1	6	10	紅	柱開關、綜合儀錶、ETACS-ECU、SRS-ECU
			7	—	—	—
	電瓶		8	10	紅	ETACS-ECU、綜合儀錶、輸入軸速度感知器、輸出軸速度感知器、倒車燈、SRS-ECU
			9	—	—	—
10			20	黃	ETACS-ECU、診斷接頭	
11			30	綠	專用保險絲 NO. 19、除霧線	
12			30	綠	鼓風機馬達	
13			10	紅	備用保險絲	
14			15	藍		
15			20	黃		
16	30	綠				

通用保險絲

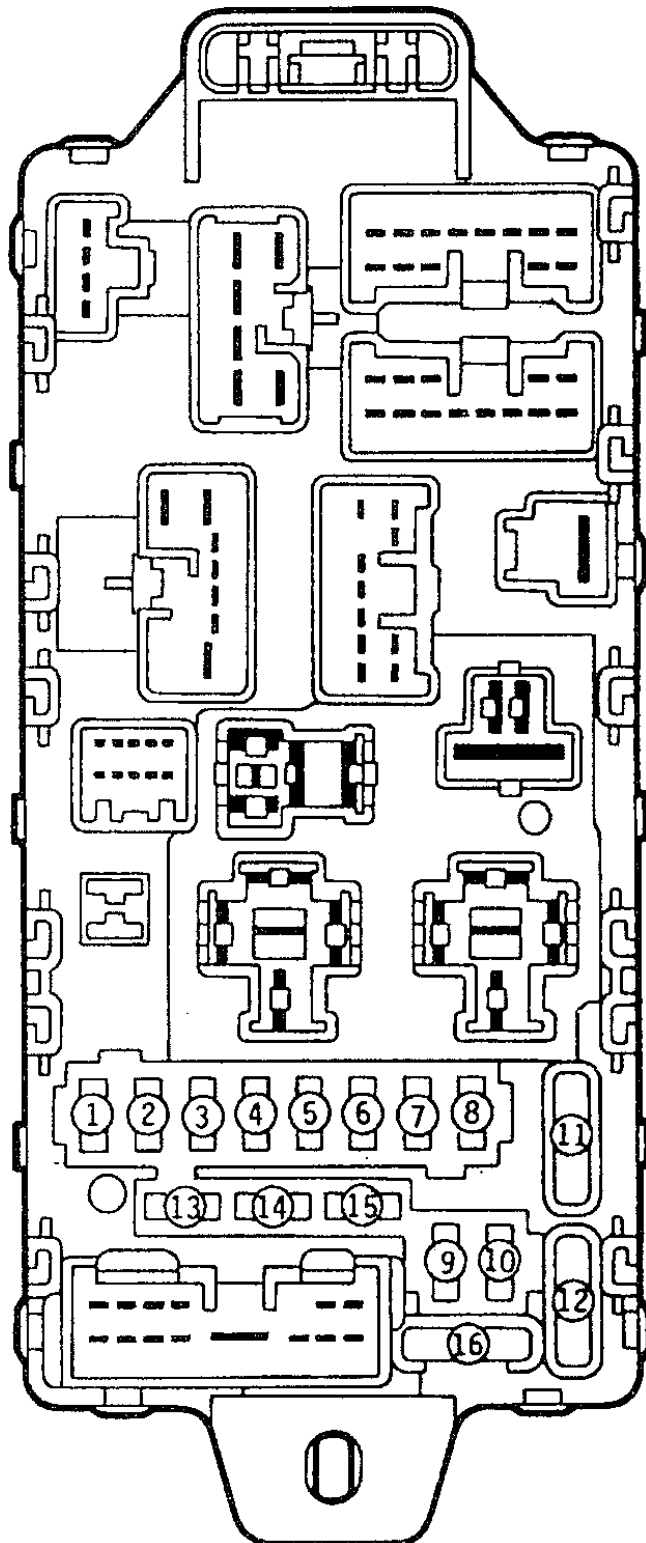

通用
保險絲

電源分配系統

2

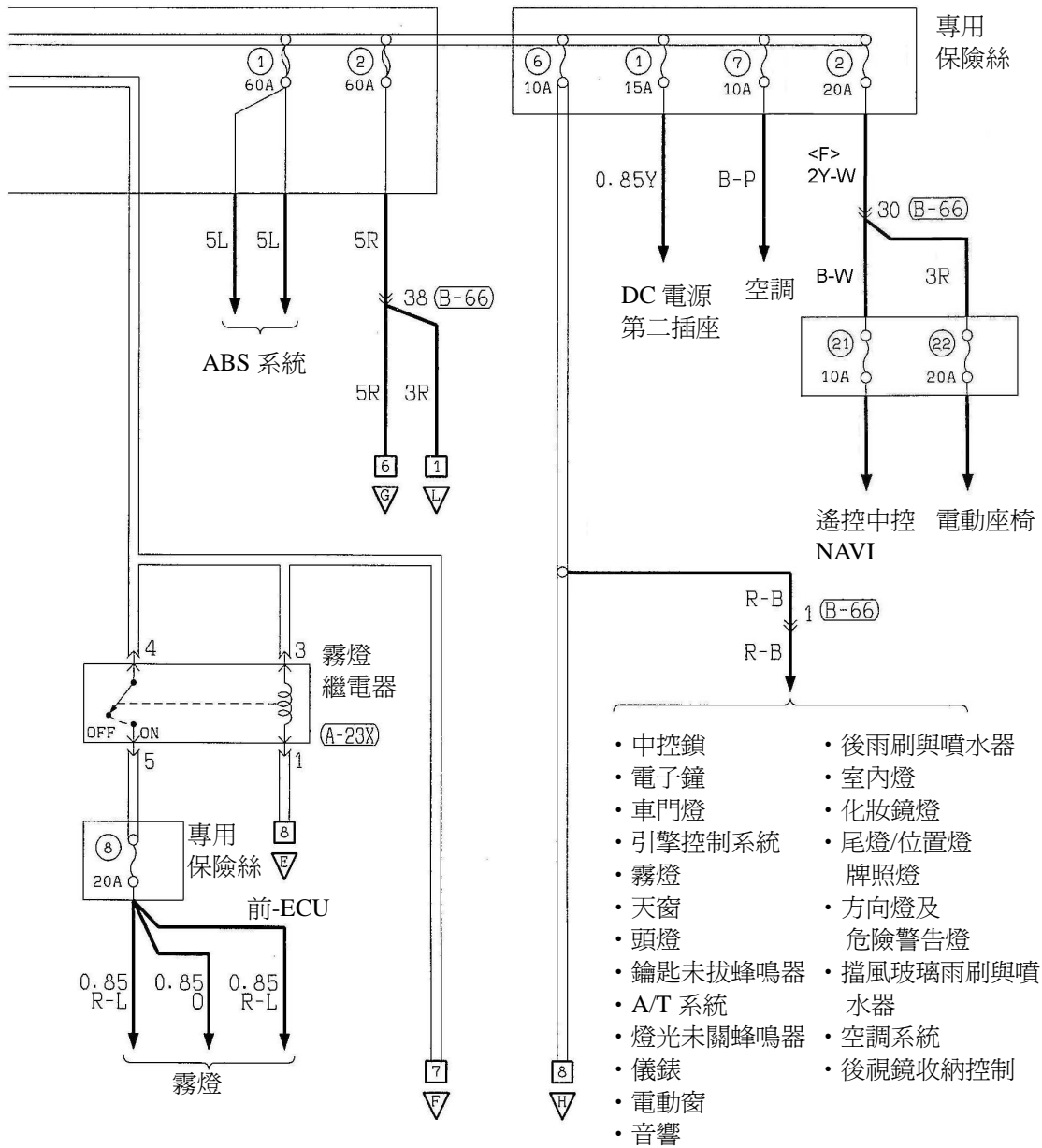

電源分配系統

3

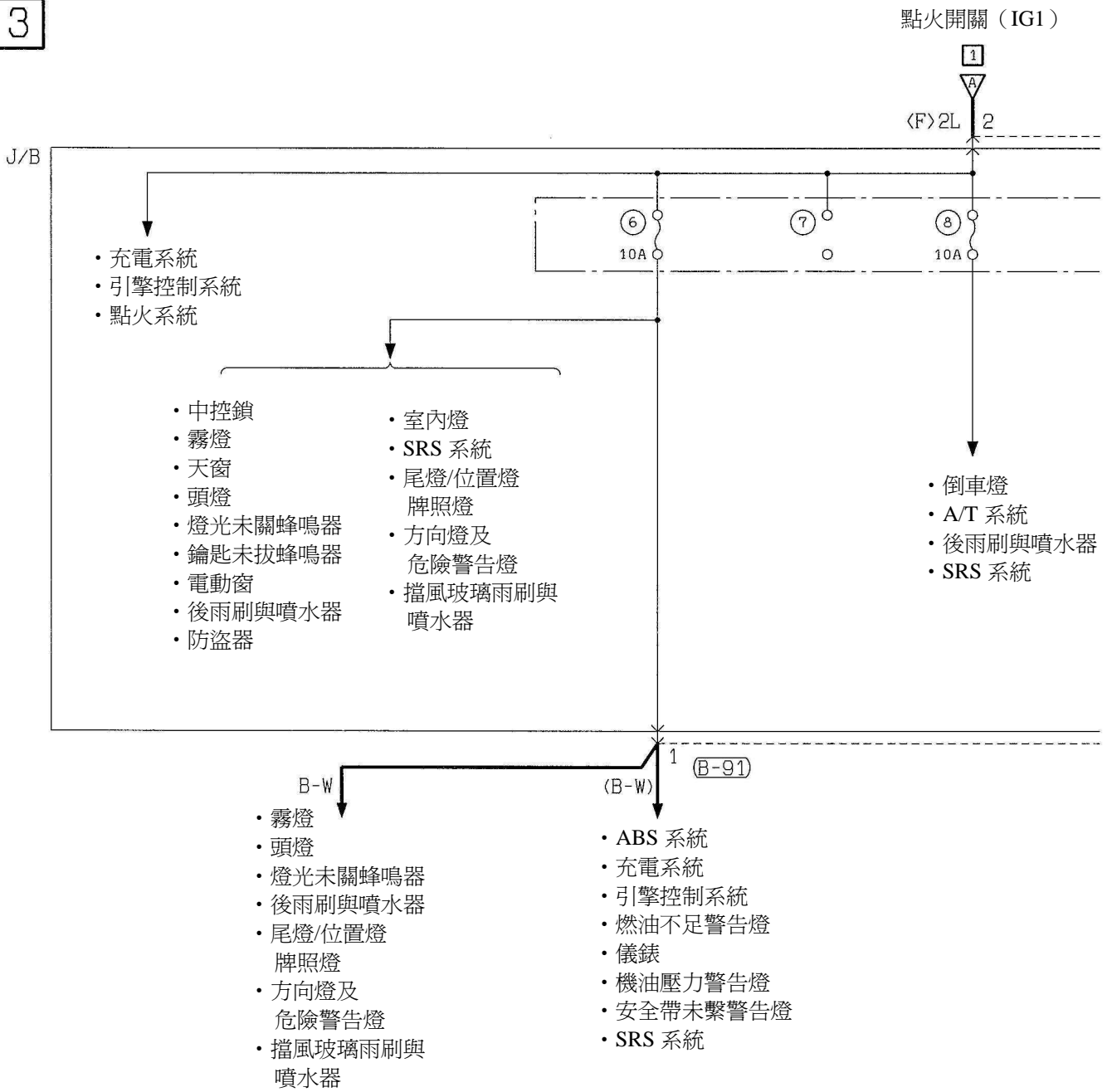

(B-66)

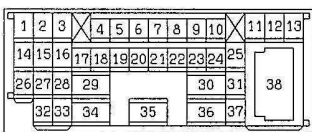

(B-68)

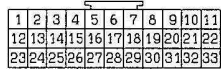

(B-89)



(B-91)

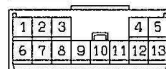

(B-96)



電源分配系統

4

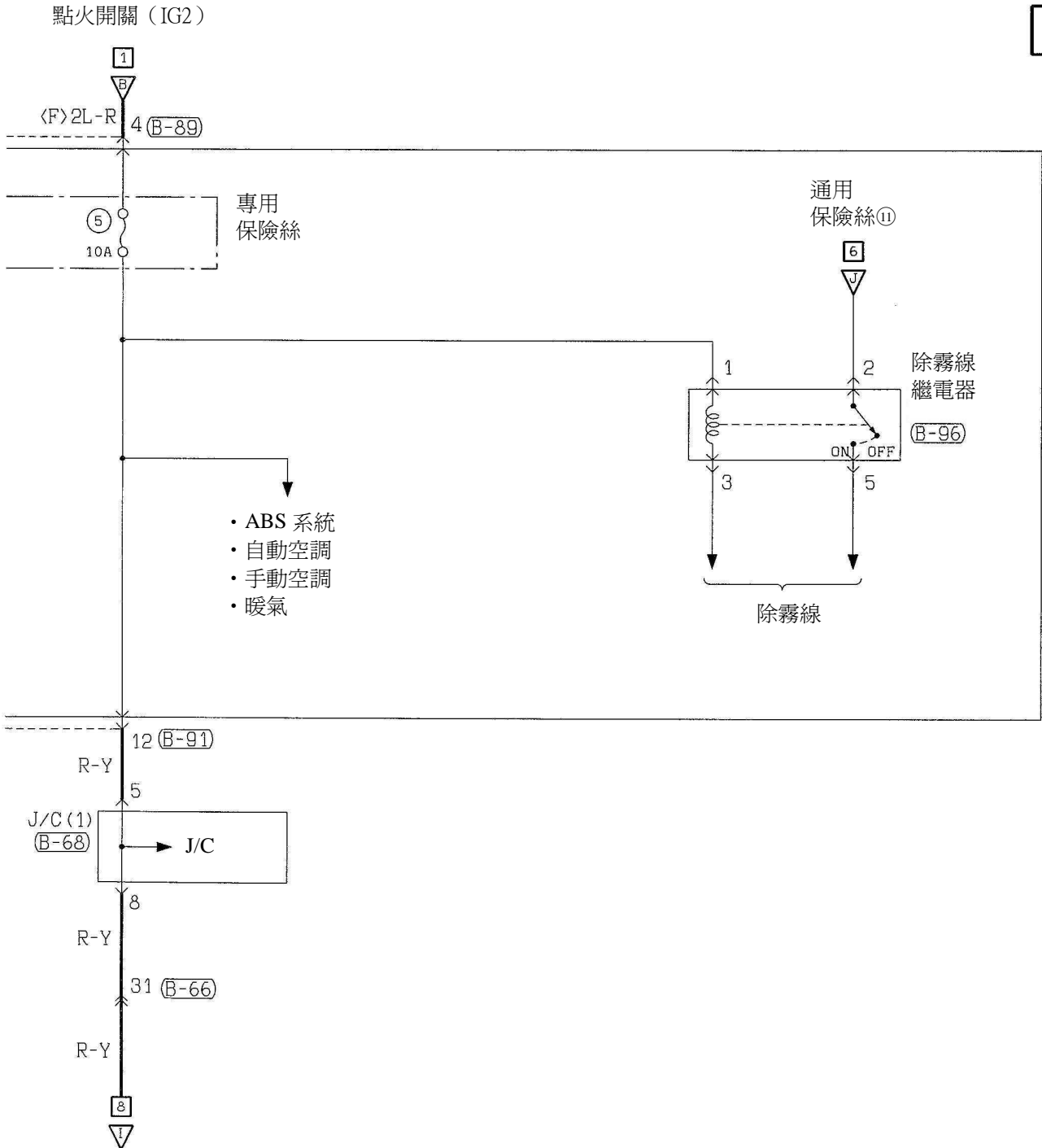

電源分配系統

5

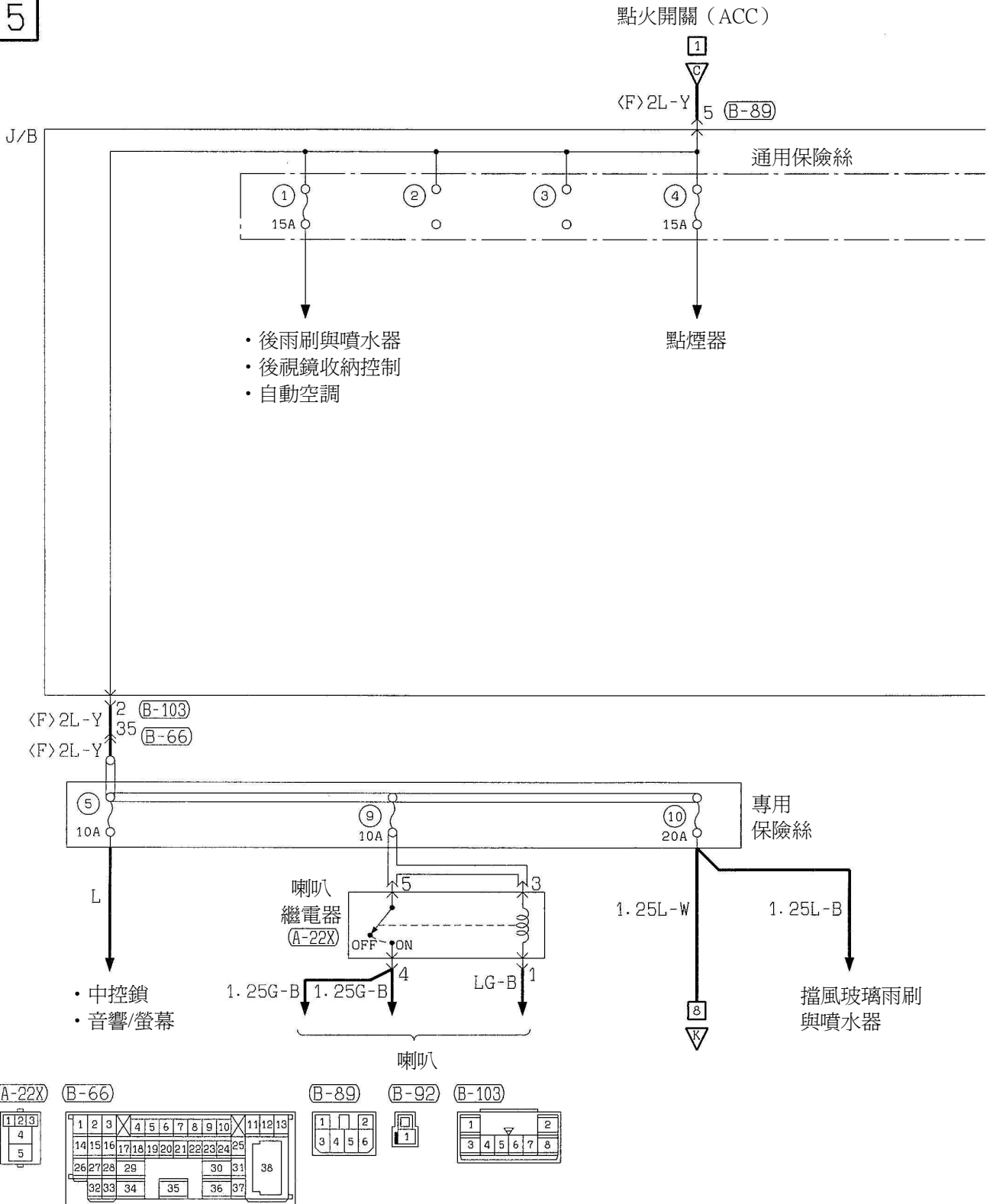

電源分配系統

6

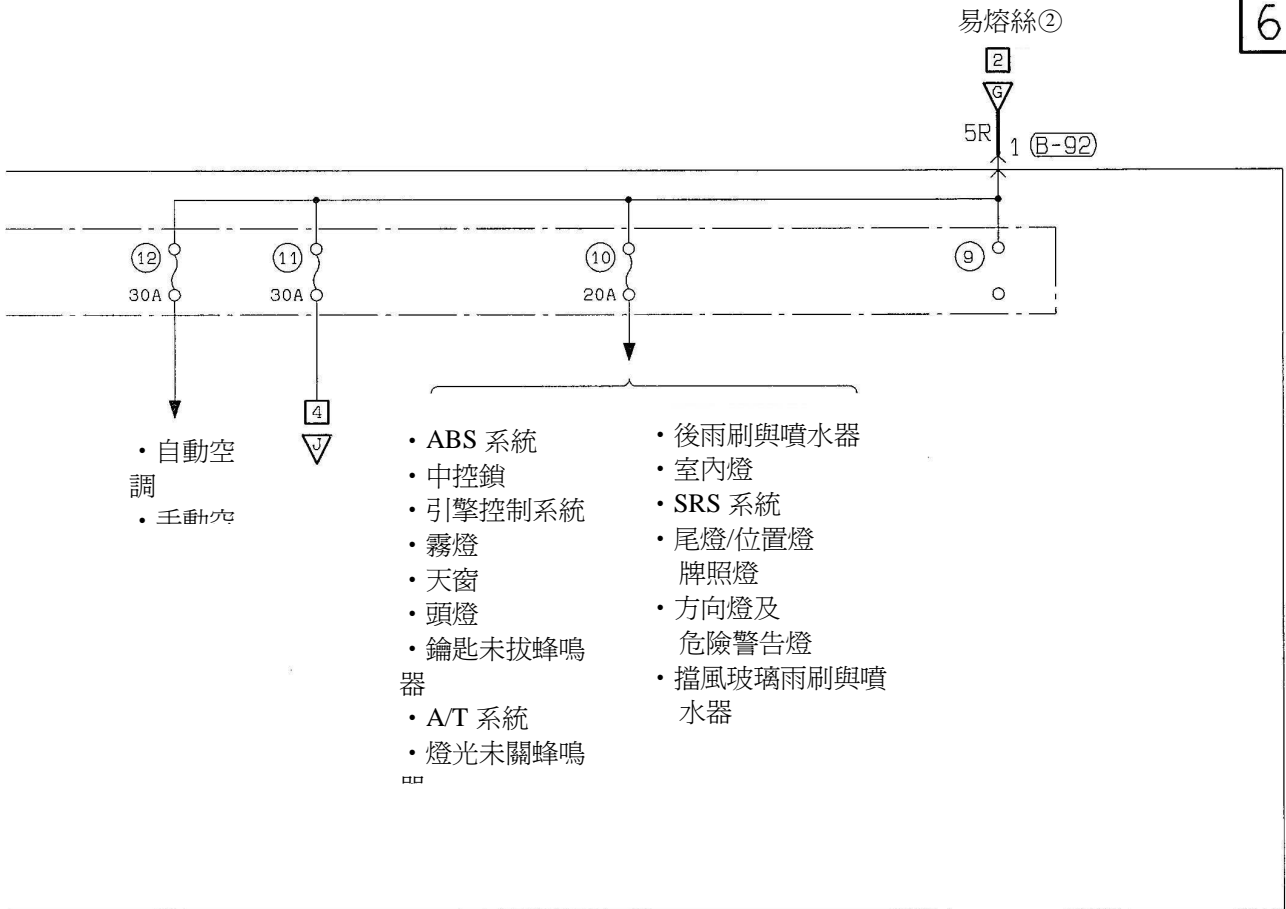

電源分配系統

7

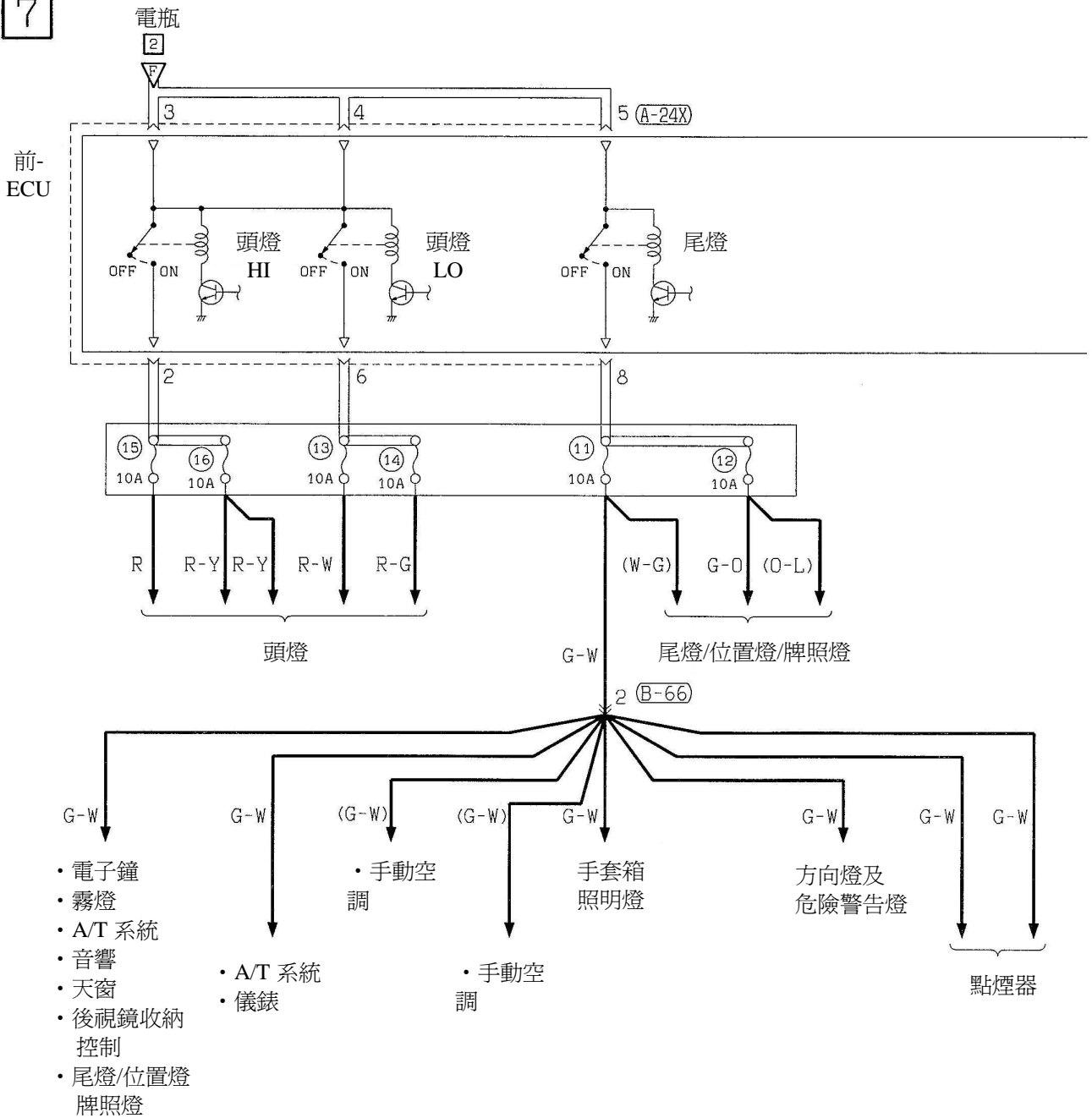

(A-24X)

1	2	3	4	5	6	7	8	9	10	11
---	---	---	---	---	---	---	---	---	----	----

(A-25X)

21	22	23	24	25	26	27	28	29	30	31
----	----	----	----	----	----	----	----	----	----	----

(B-66)

1	2	3	4	5	6	7	8	9	10	11	12	13
14	15	16	17	18	19	20	21	22	23	24	25	
26	27	28	29					30	31			38
32	33	34		35				36	37			

電源分配系統

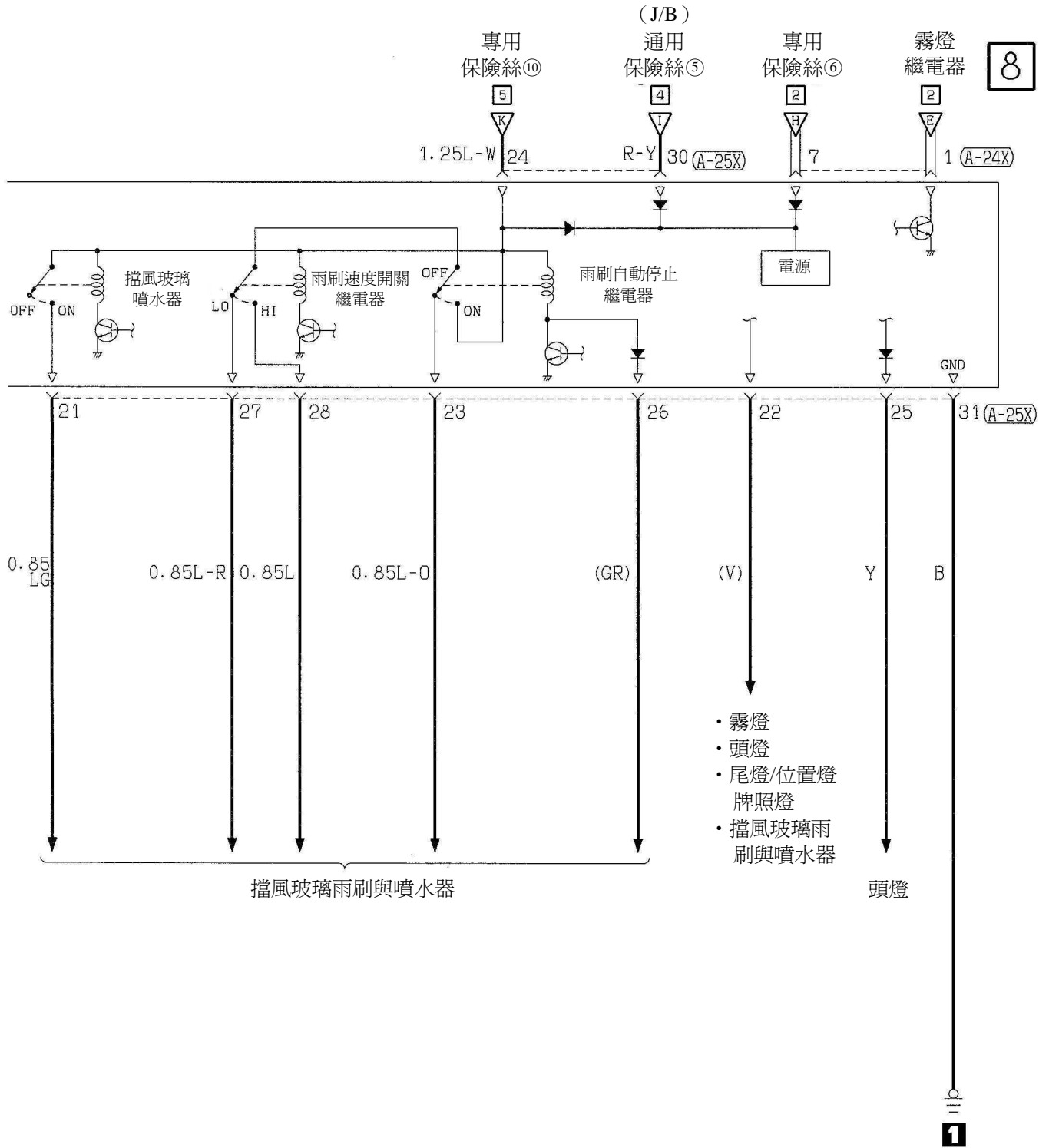

起動系統

1

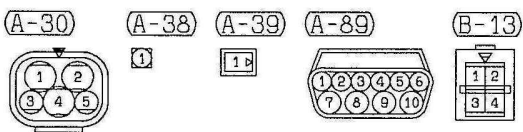
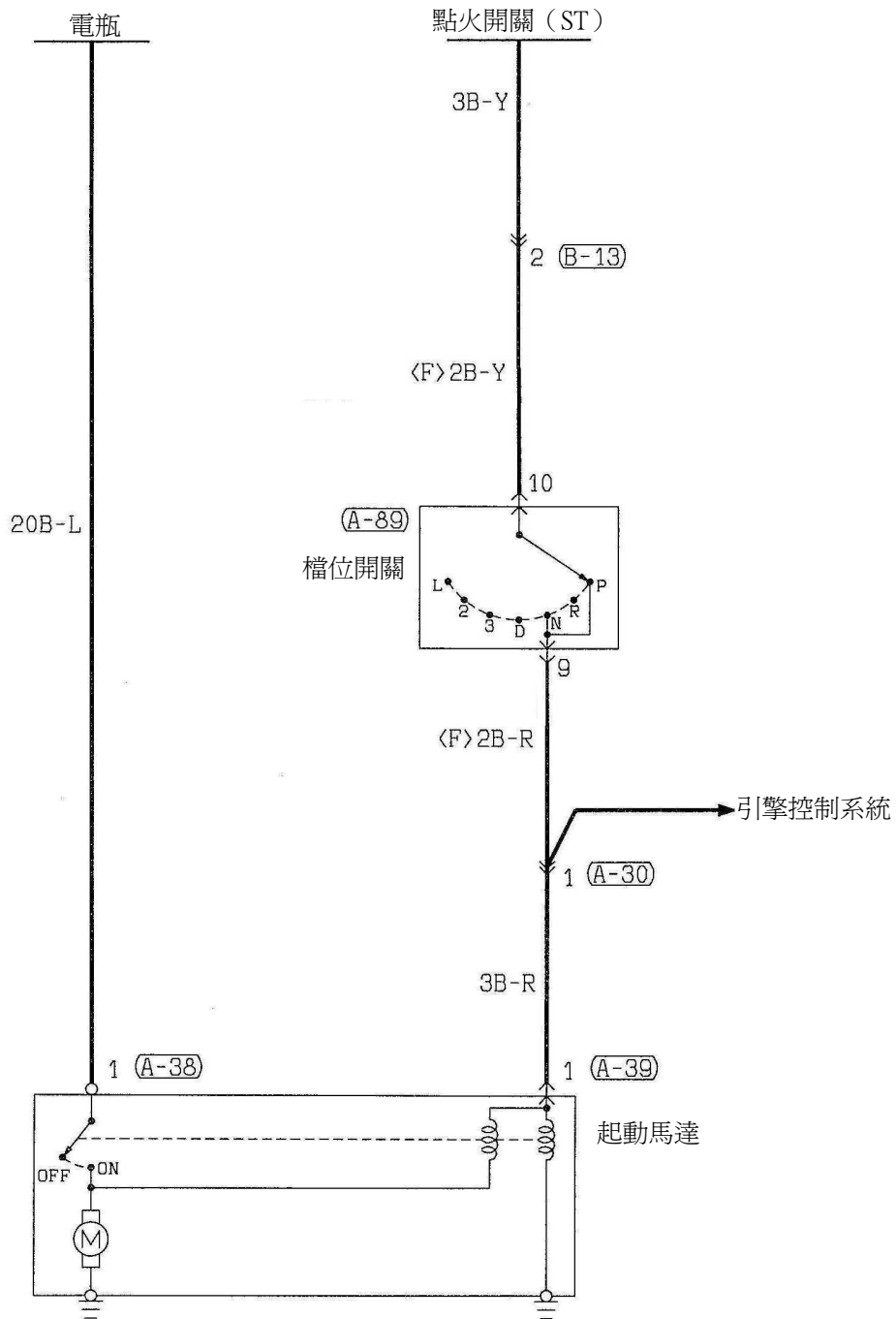

點火系統

1

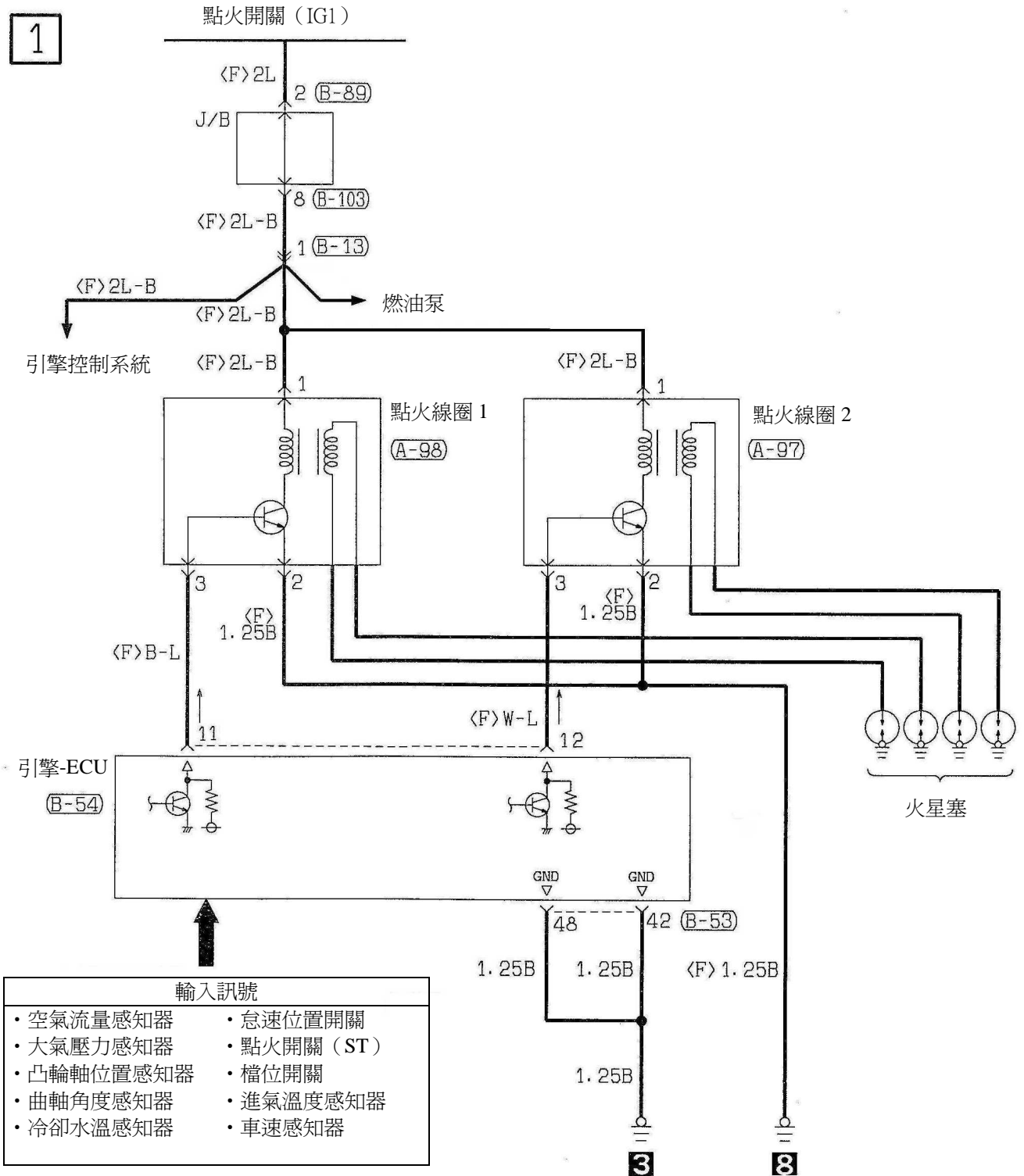

(A-97)

(A-98)

(B-13)

(B-53)

(MU801822)

(B-54)

(B-103)

(C-89)

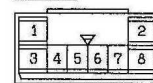
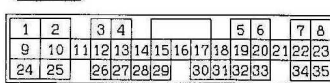
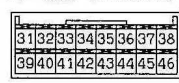

充電系統

1

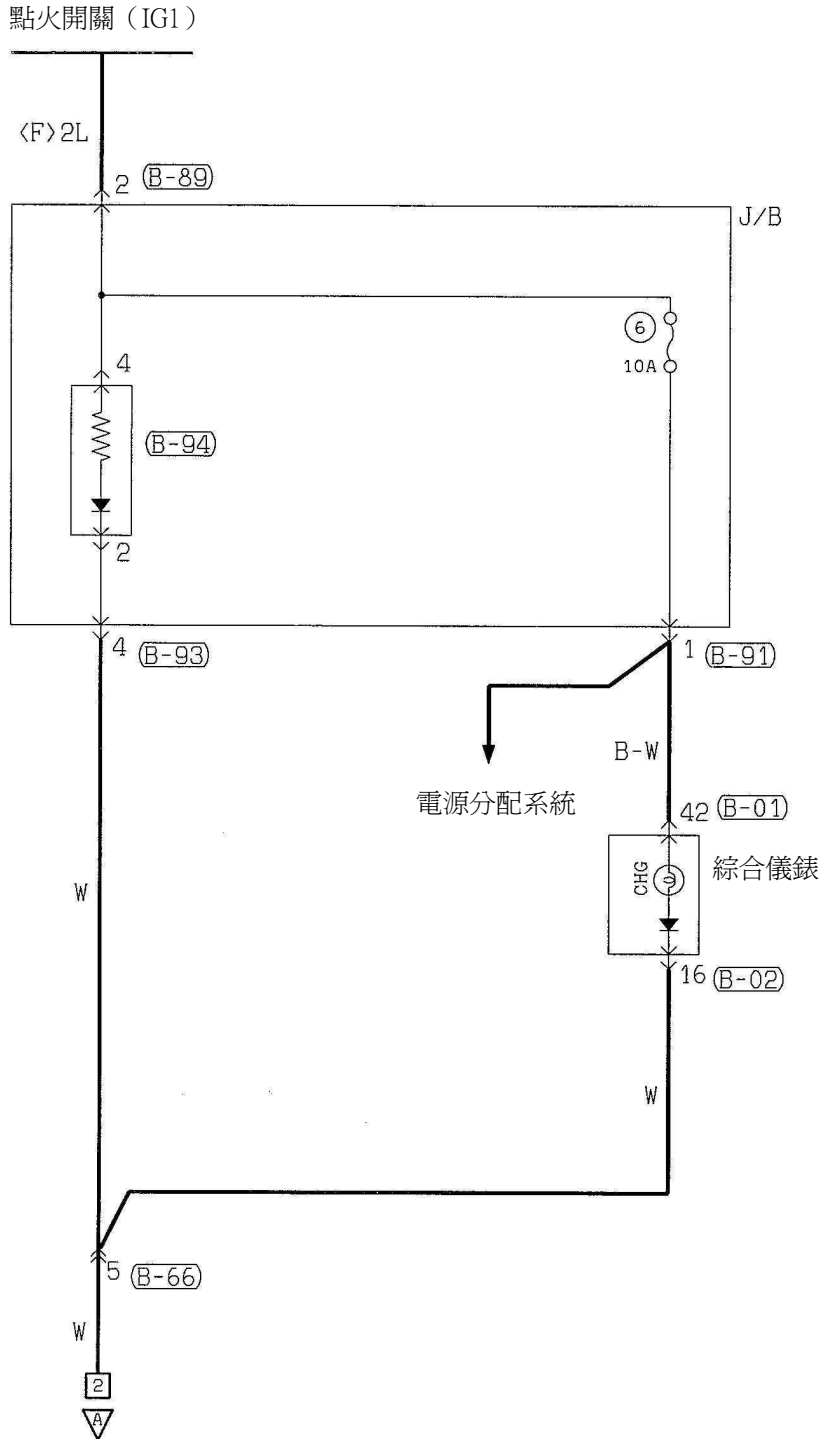

(A-29)
MU802083



(A-30)
MU802227

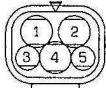

(A-50)

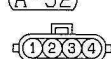

(A-52)

(B-01)

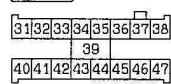

(B-02)

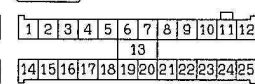

(B-54)

1	2	3	4	5	6	7	8
9	10	11	12	13	14	15	16
17	18	19	20	21	22	23	24
25	26	27	28	29	30	31	32
33	34	35					

充電系統

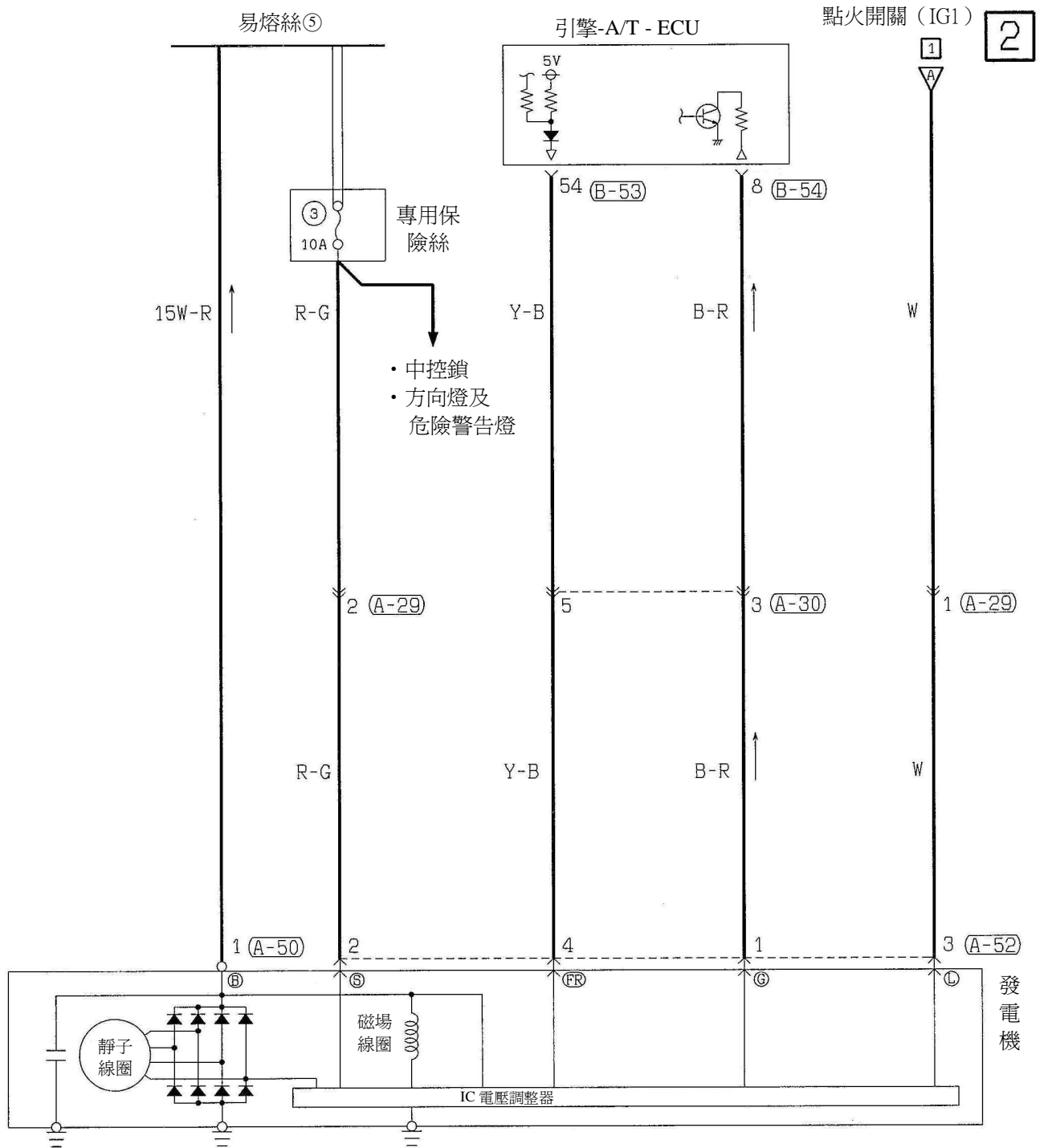

B-66

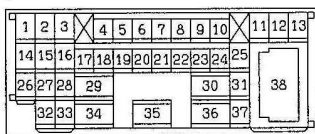

B-89

MU801331



B-91 (MU801860)

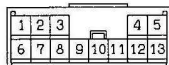

B-93 MU801847

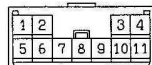

B-53 (MU803781)

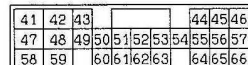

引擎控制系統

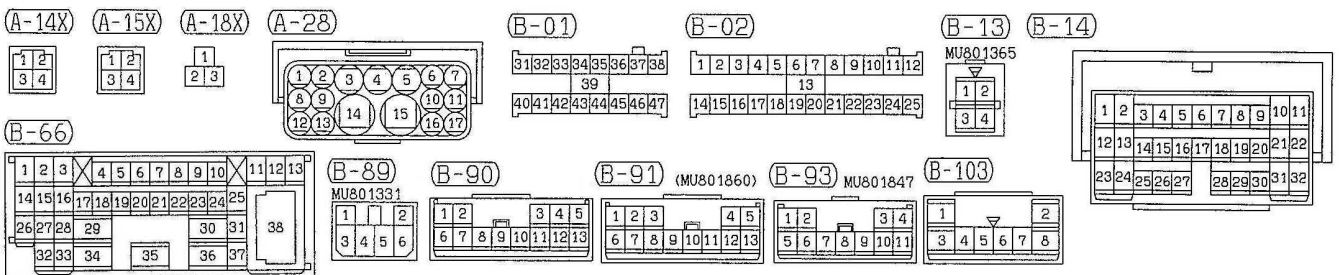
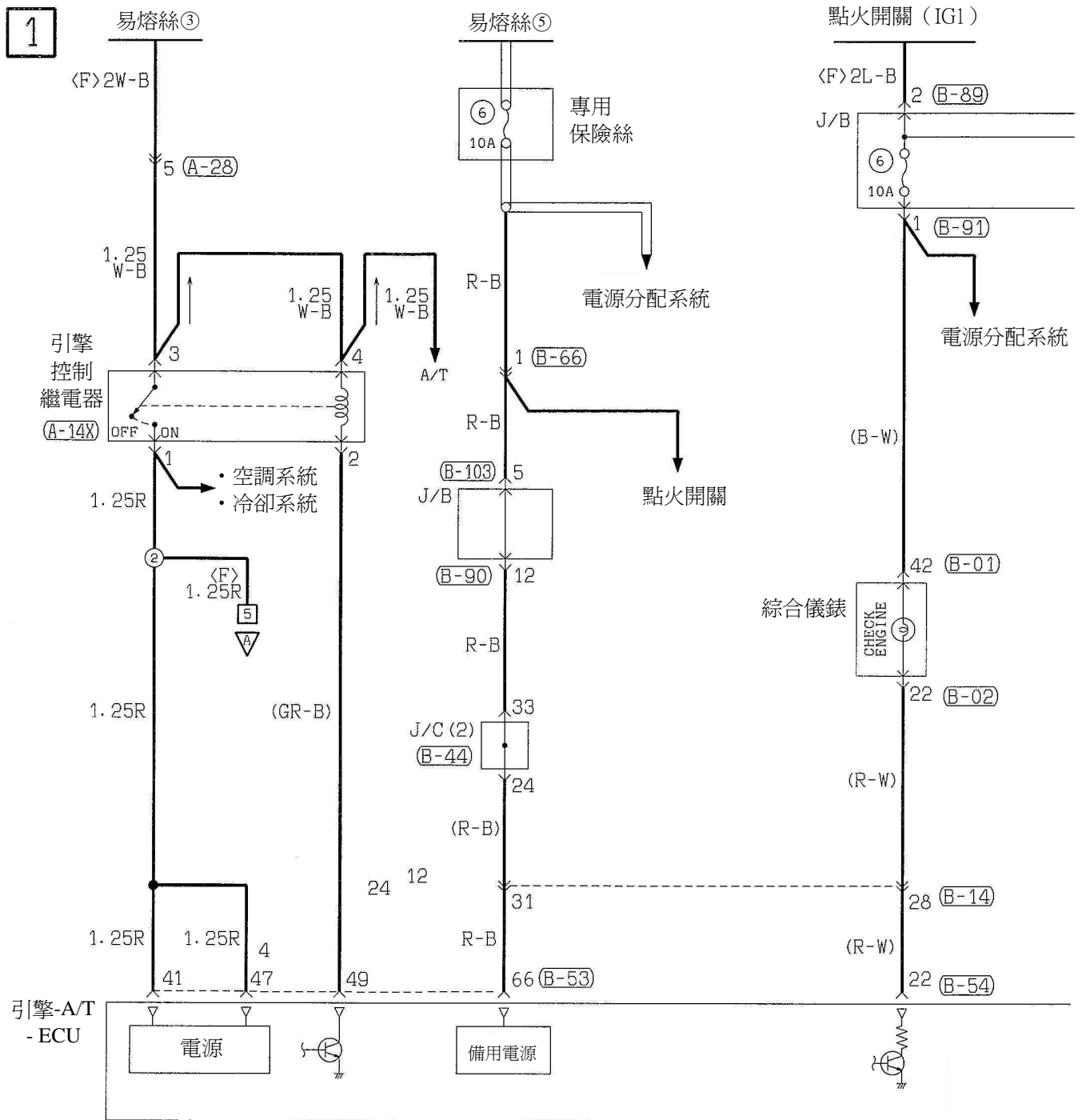

引擎控制系統

3

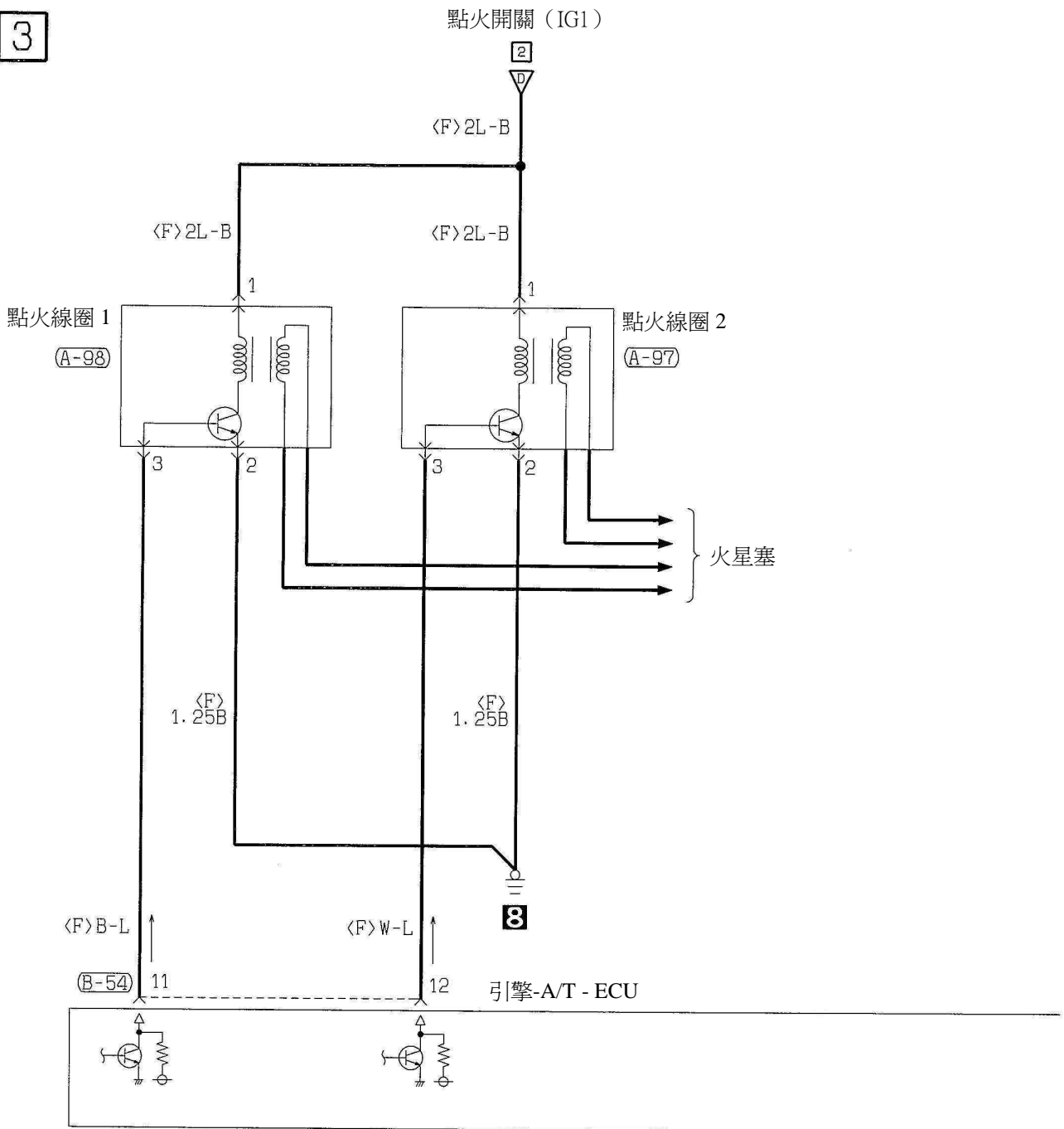

A-28

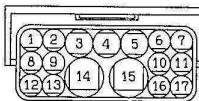

A-30

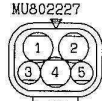

A-89

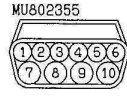

A-97



A-98

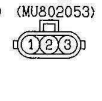

B-13

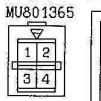

B-14

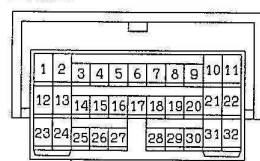

B-51

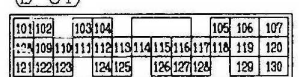

引擎控制系統

4

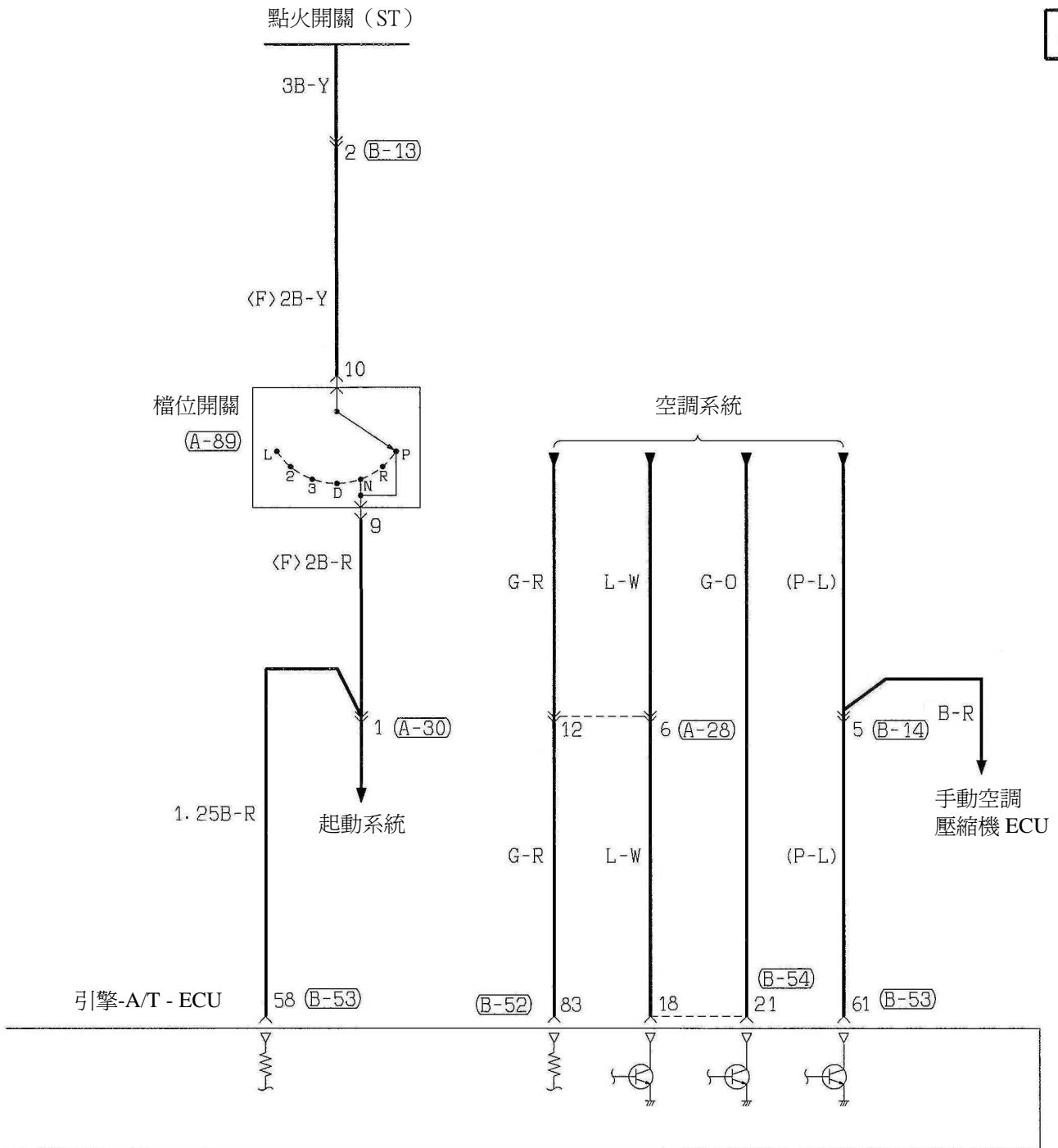

(B-52)

71	72	73	74		75	76	77
78	79	80	81	82	83	84	85
86	87	88	89				
90	91	92	93	94	95	96	97
							98

(B-53)

41	42	43			44	45	46
47	48	49	50	51	52	53	54
55	56	57					
58	59	60	61	62	63	64	65
							66

(B-54)

1	2	3	4			5	6
7	8						
9	10	11	12	13	14	15	16
17	18	19	20	21	22	23	
24	25	26	27	28	29	30	31
32	33	34	35				

引擎控制系統

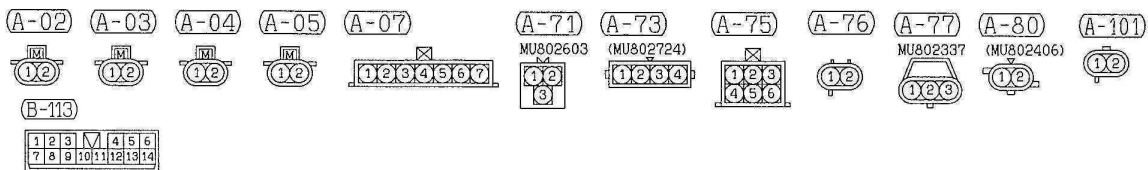
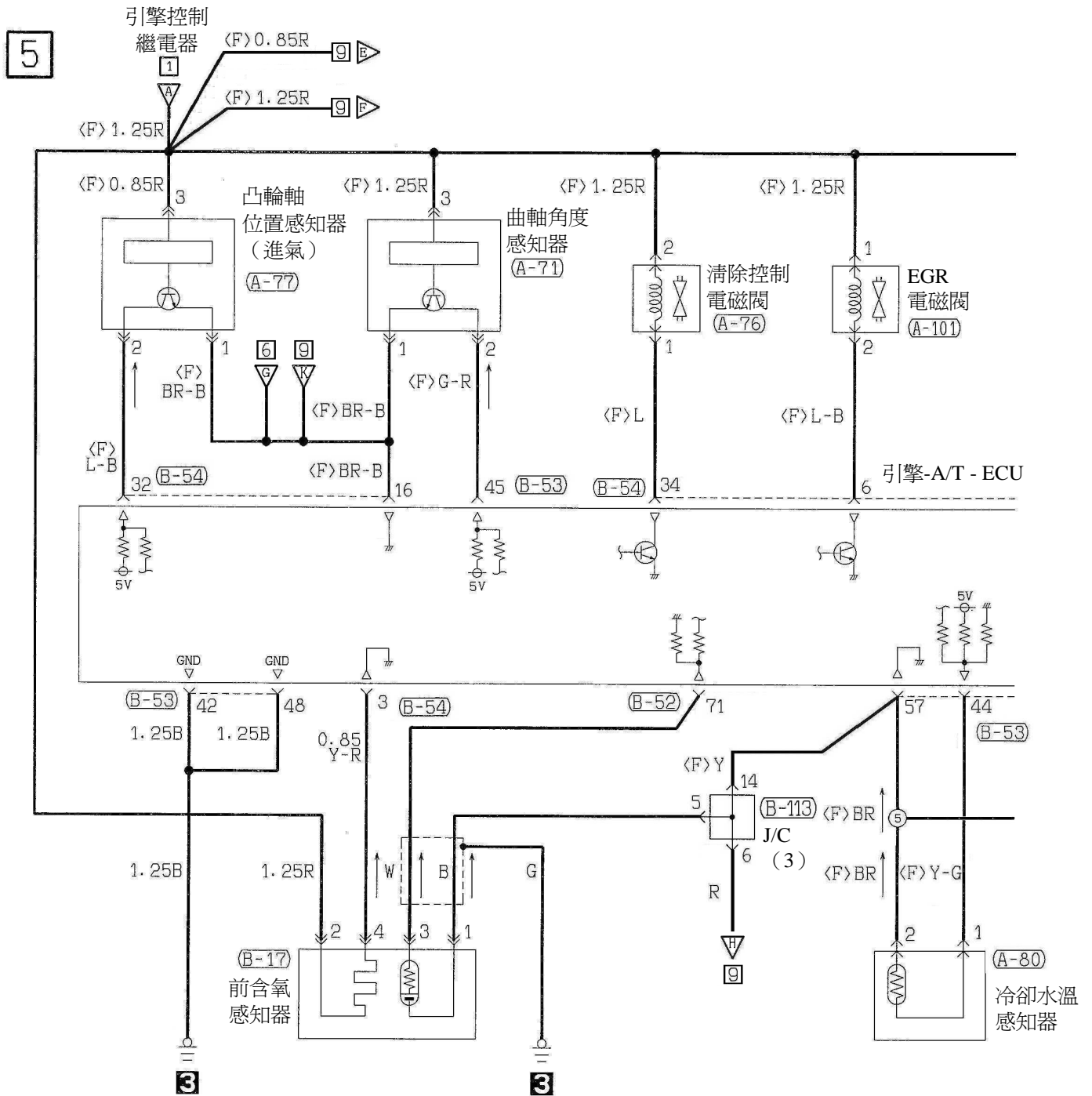

引擎控制系統

6

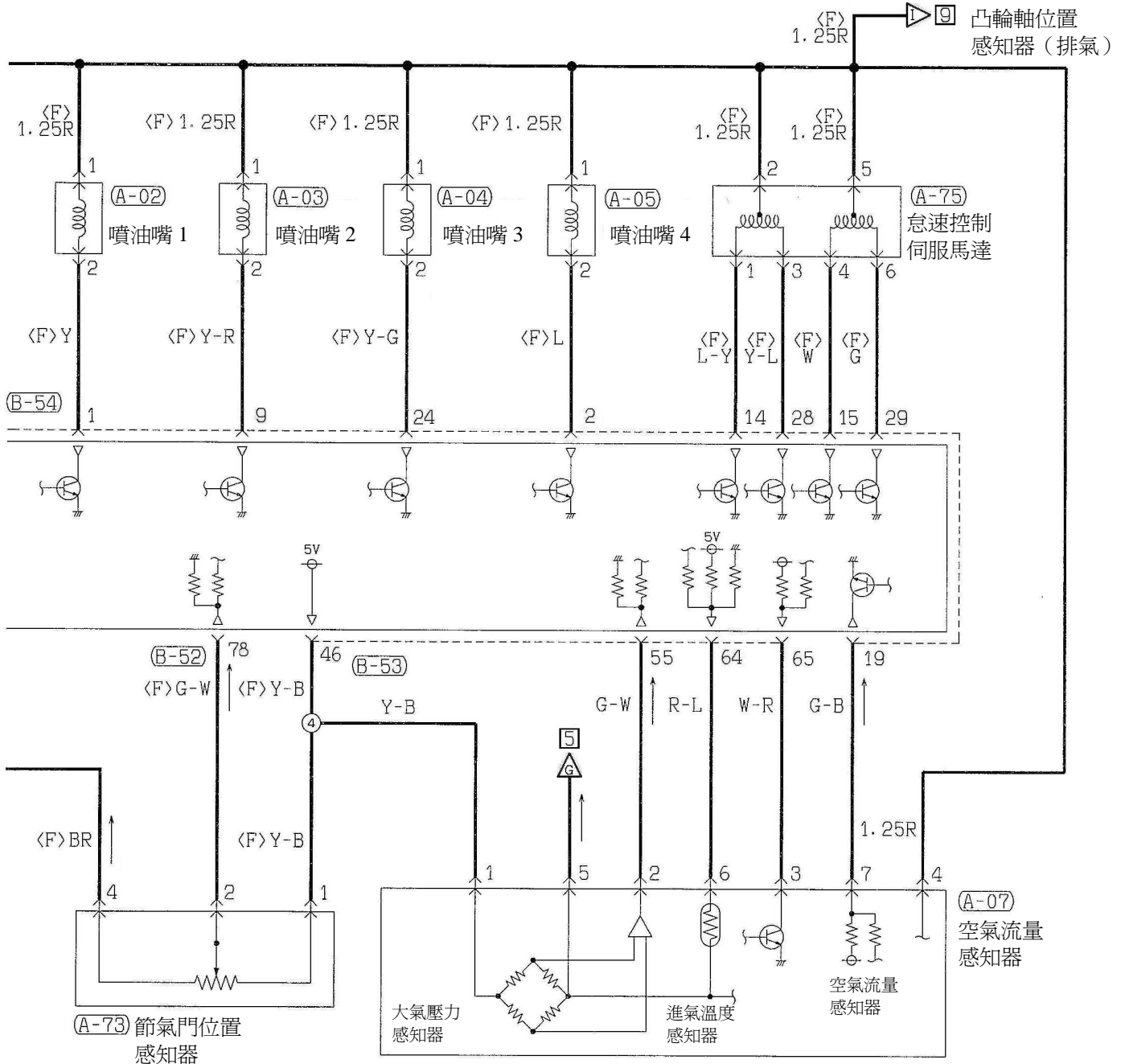

(B-17) MU802606

1	2	3	4	5	6	7	8
9	10	11	12	13	14	15	16
17	18	19	20	21	22	23	24
25	26	27	28	29	30	31	32
33	34	35	36	37	38	39	40

(B-52)

71	72	73	74	75	76	77
78	79	80	81	82	83	84
85	86	87	88	89	90	91
92	93	94	95	96	97	98

(B-53)

41	42	43	44	45	46
47	48	49	50	51	52
53	54	55	56	57	58
59	60	61	62	63	64
65	66	67	68	69	70

(B-54)

1	2	3	4	5	6	7	8
9	10	11	12	13	14	15	16
17	18	19	20	21	22	23	24
25	26	27	28	29	30	31	32
33	34	35	36	37	38	39	40

引擎控制系統

7

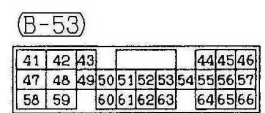
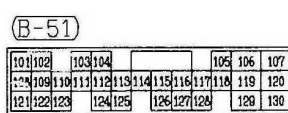
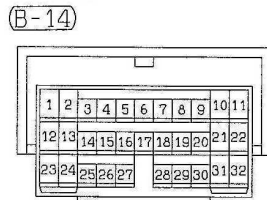
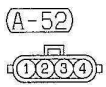
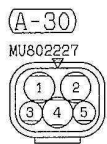
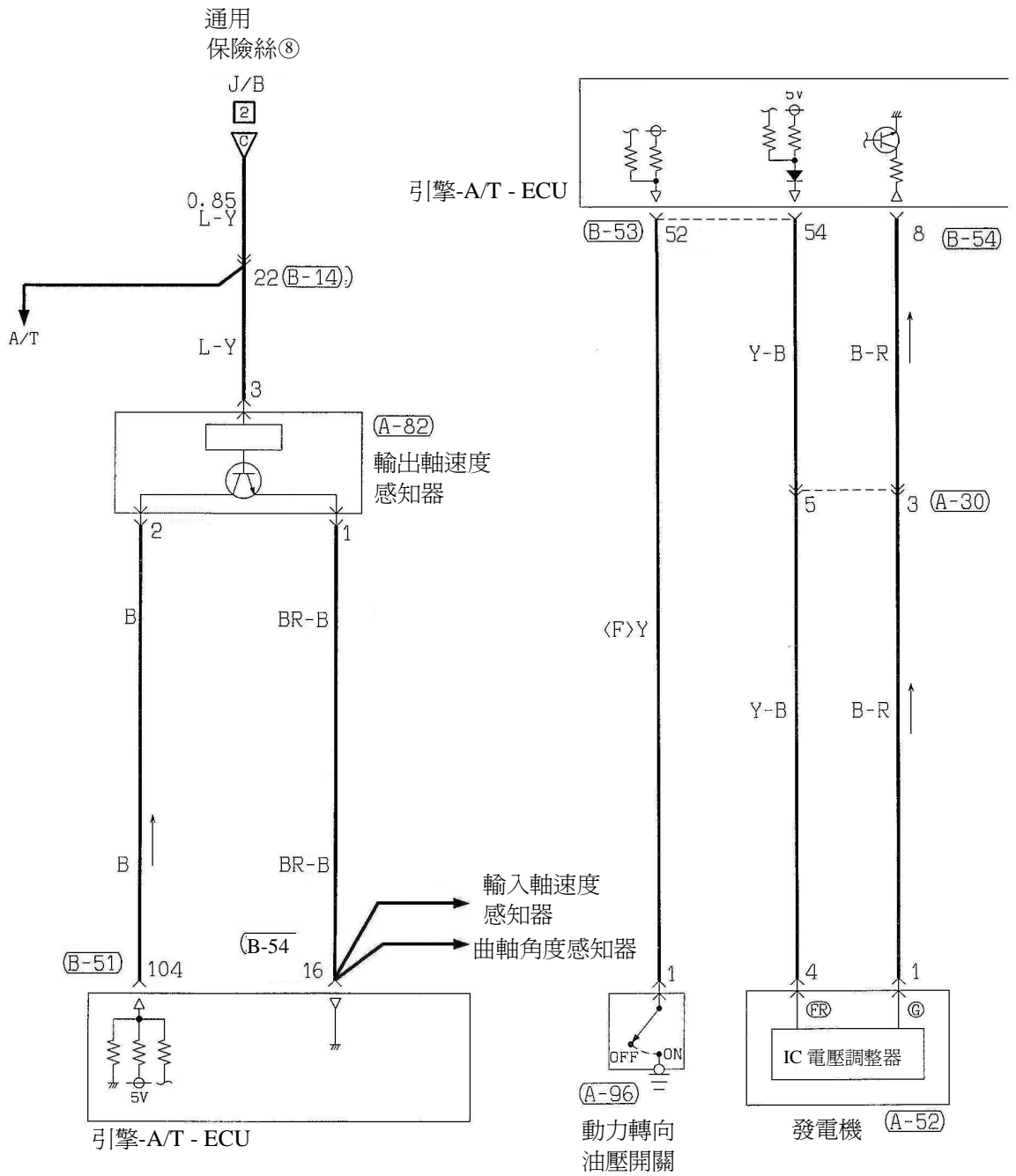

引擎控制系統

8

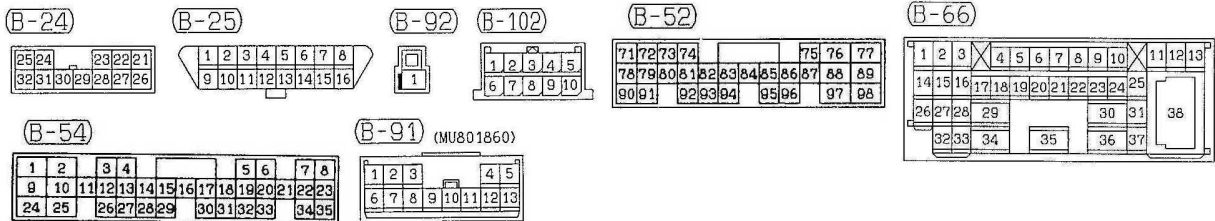
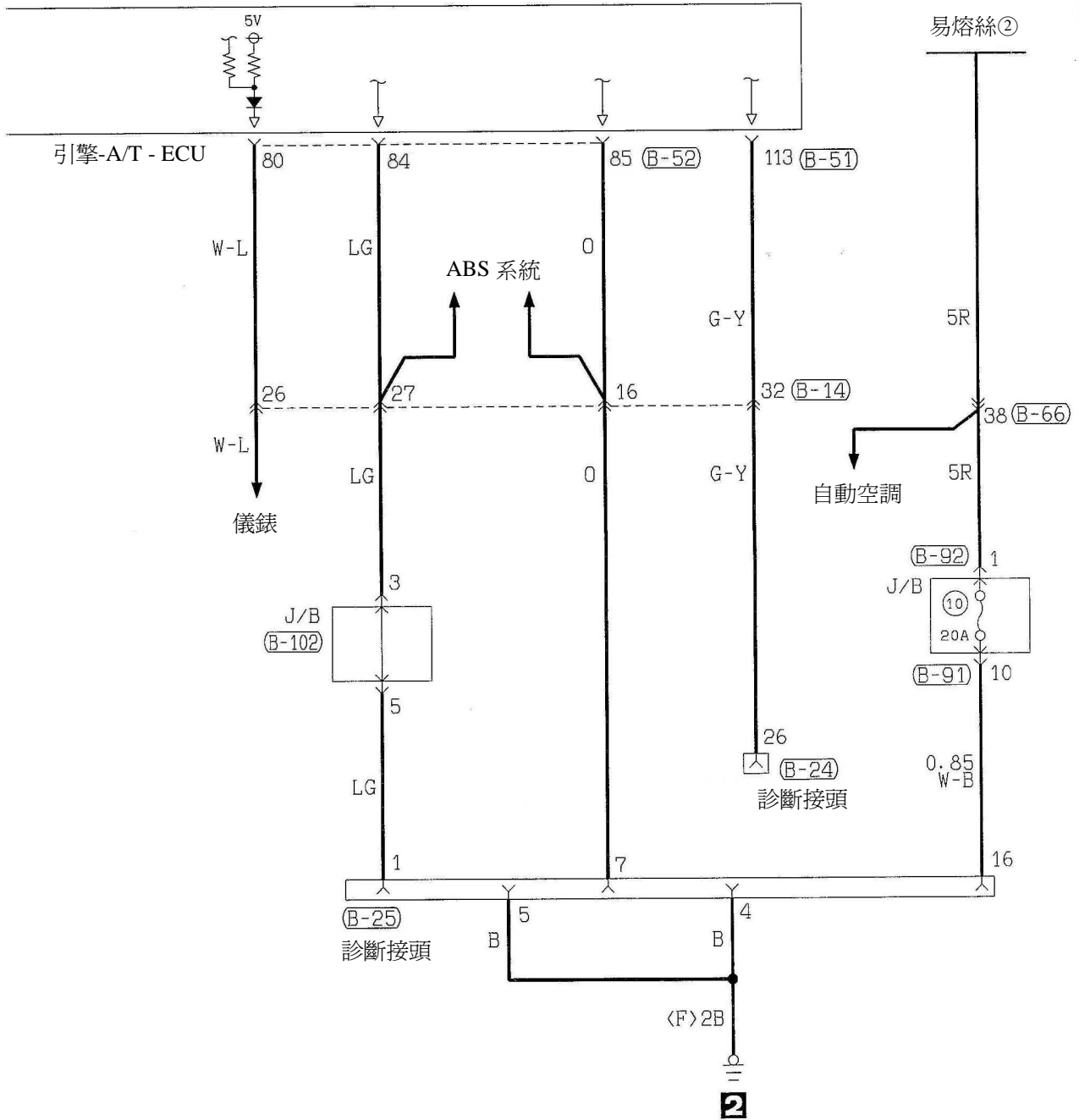

引擎控制系統

9

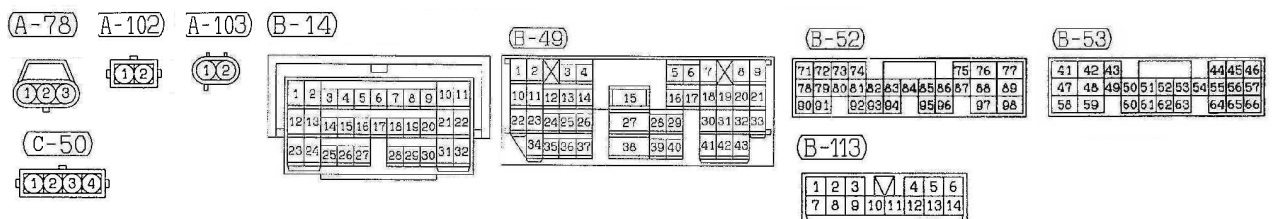
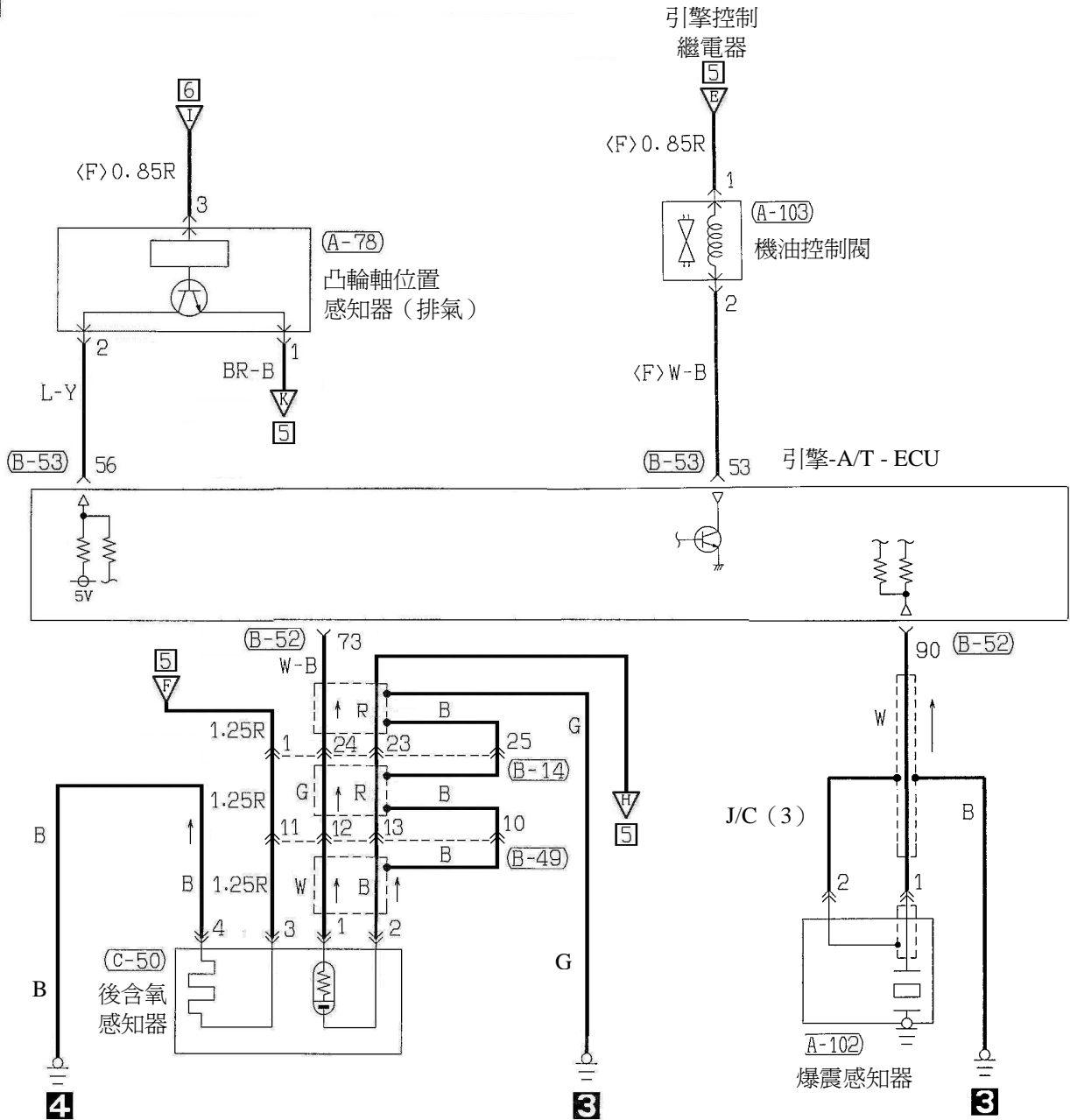

INVECS-II 4A/T

1

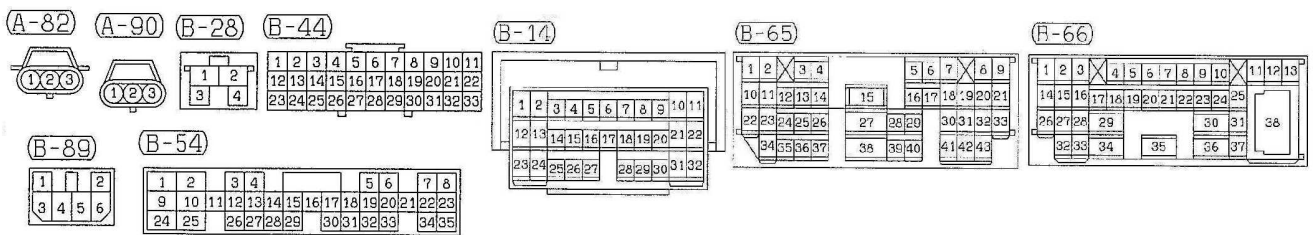
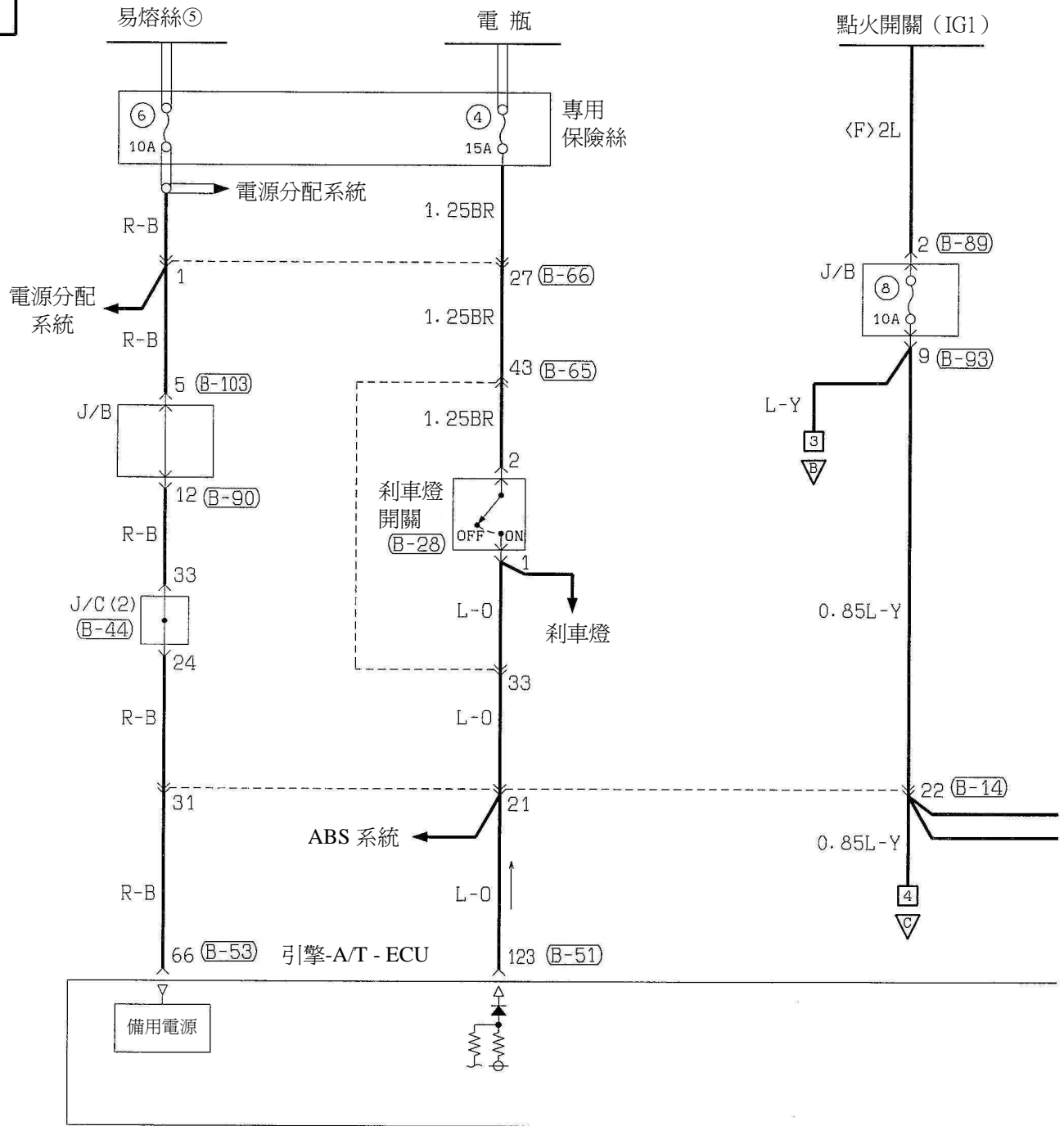

INVECS-II 4A/T

2

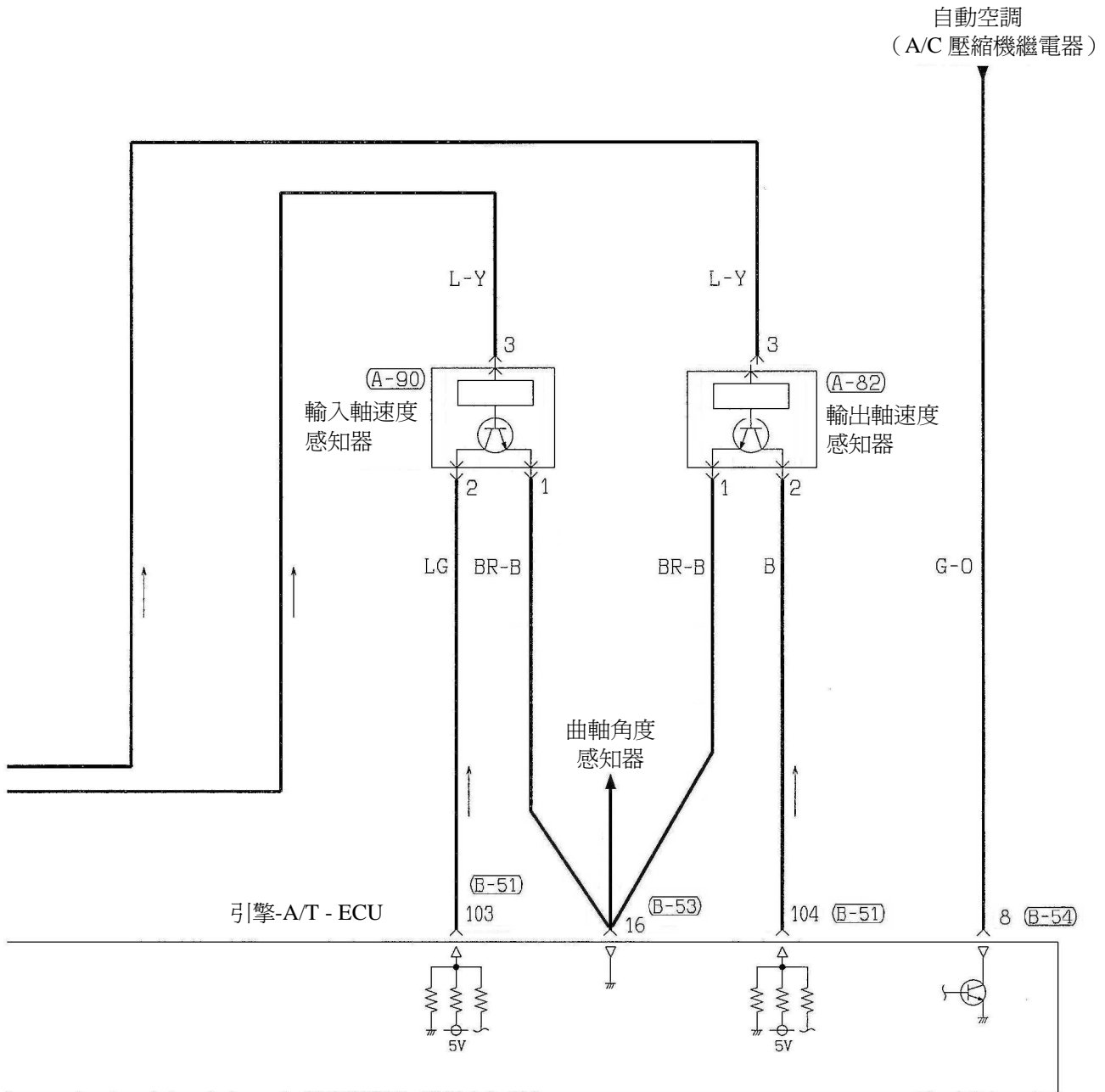

(B-90) MU801855

1	2	3	4	5
6	7	8	9	10
11	12	13		

(B-93) MU801847

1	2	3	4
5	6	7	8
9	10	11	

(B-103)

1	2
3	4
5	6
7	8

(B-51)

101	102	103	104	105	106	107
108	109	110	111	112	113	114
115	116	117	118	119	120	
121	122	123	124	125	126	127
128	129	130				

(B-53)

41	42	43	44	45	46
47	48	49	50	51	52
53	54	55	56	57	
58	59	60	61	62	63
64	65	66			

INVECS-II 4A/T

3

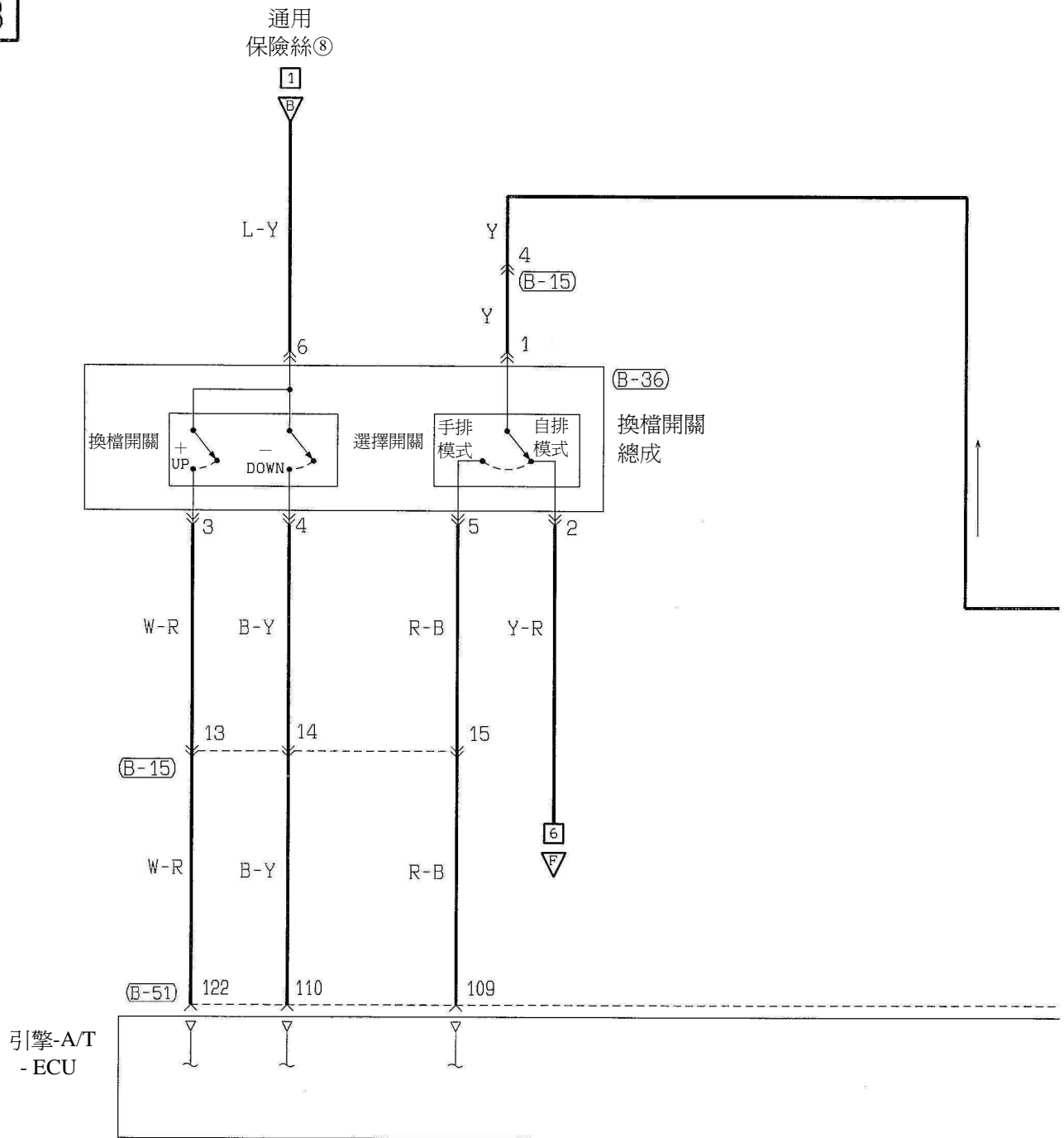

(A-89)
MU802355

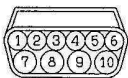

(B-13)
MU801365



(B-15)

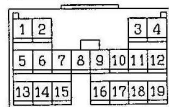

(B-36)
MU801447



(B-51)

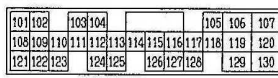

INVECS-II 4A/T

4

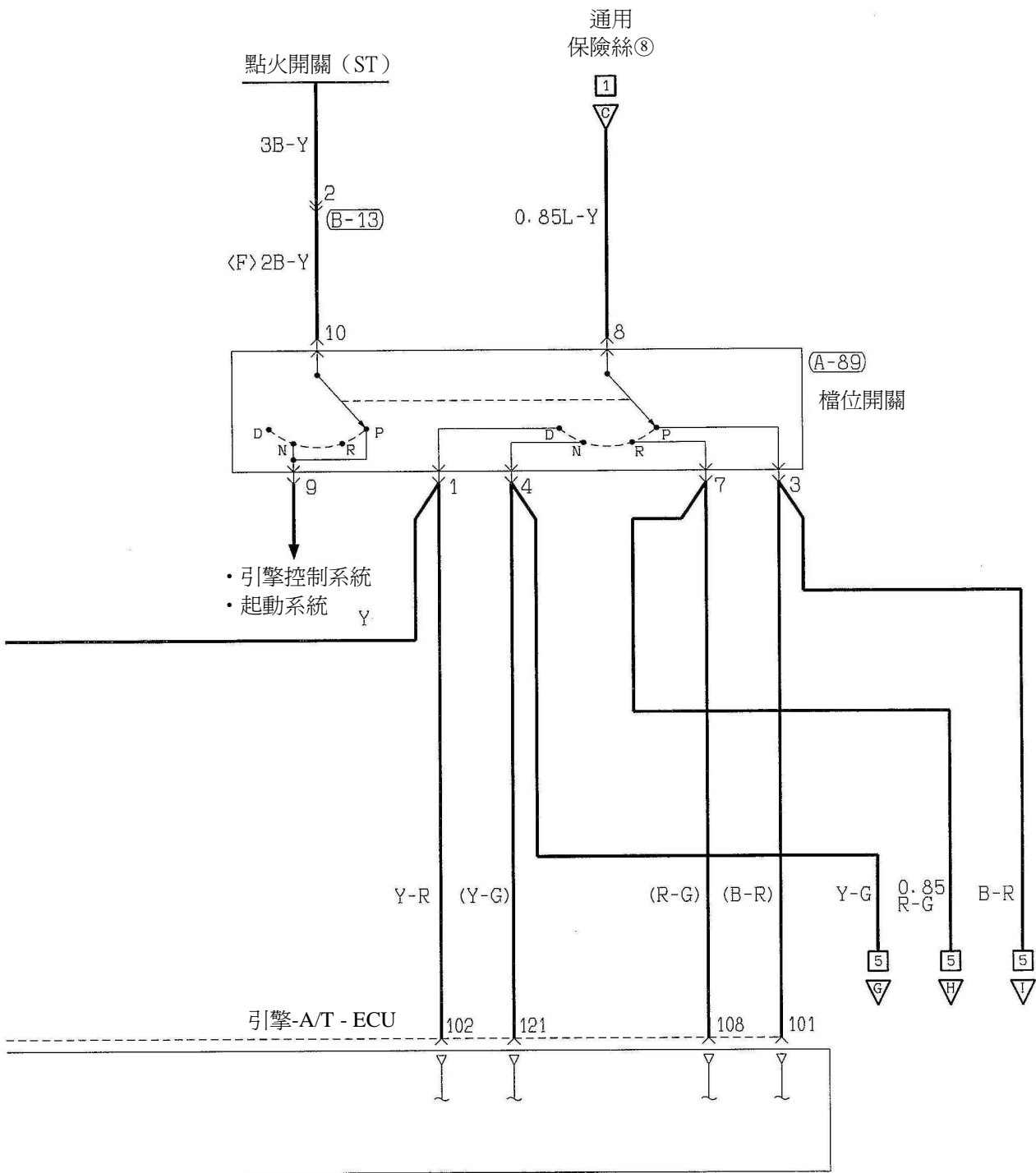

INVECS-II 4A/T

5

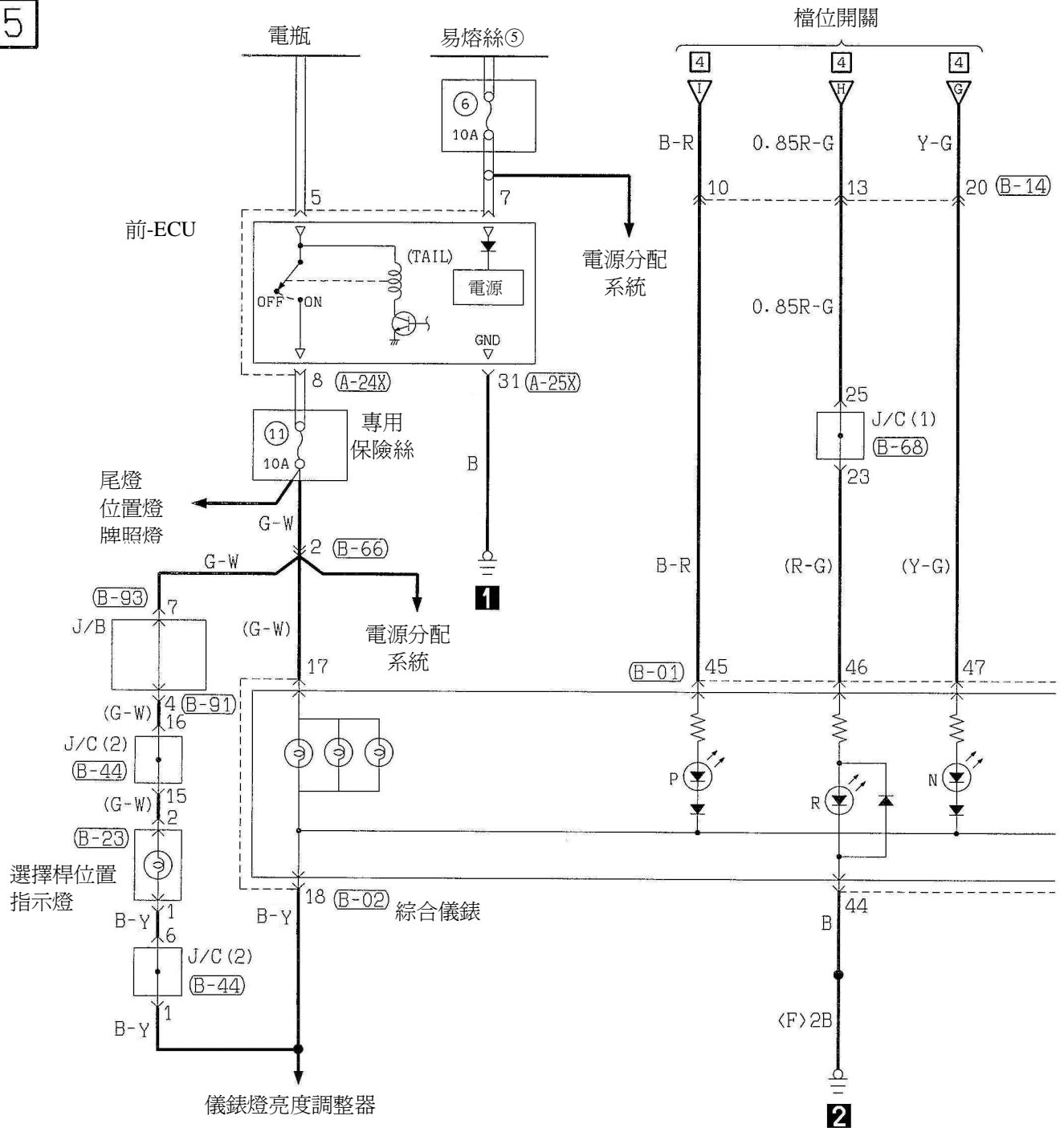

(A-24X)	(A-25X)	(B-01)	(B-02)
1 2 3 4 5 6 7 8 9 10 11	21 22 23 24 25 26 27 28 29 30 31	31 32 33 34 35 36 37 38	1 2 3 4 5 6 7 8 9 10 11 12
		39	13
		40 41 42 43 44 45 46 47	14 15 16 17 18 19 20 21 22 23 24 25
(B-68)	(B-91) (MU801860)	(B-93) MU801847	(B-51)
1 2 3 4 5 6 7 8 9 10 11	1 2 3 4 5	1 2 3 4	101 102 103 104
12 13 14 15 16 17 18 19 20 21 22	6 7 8 9 10 11 12 13	5 6 7 8 9 10 11	105 106 107
23 24 25 26 27 28 29 30 31 32 33			108 109 110 111 112 113
			114 115 116 117 118 119 120
			121 122 123 124 125
			126 127 128 129 130
			(B-52)
			71 72 73 74
			75 76 77
			78 79 80 81 82 83 84 85 86 87 88 89
			90 91 92 93 94 95 96 97 98

INVECS-II 4A/T

6

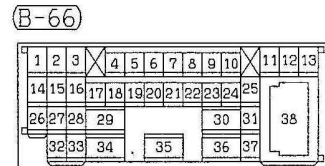
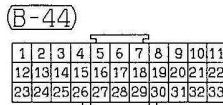
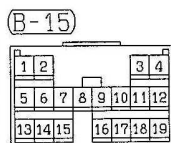
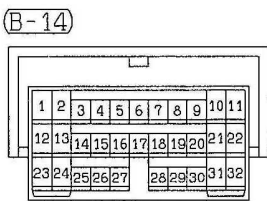
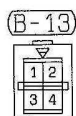
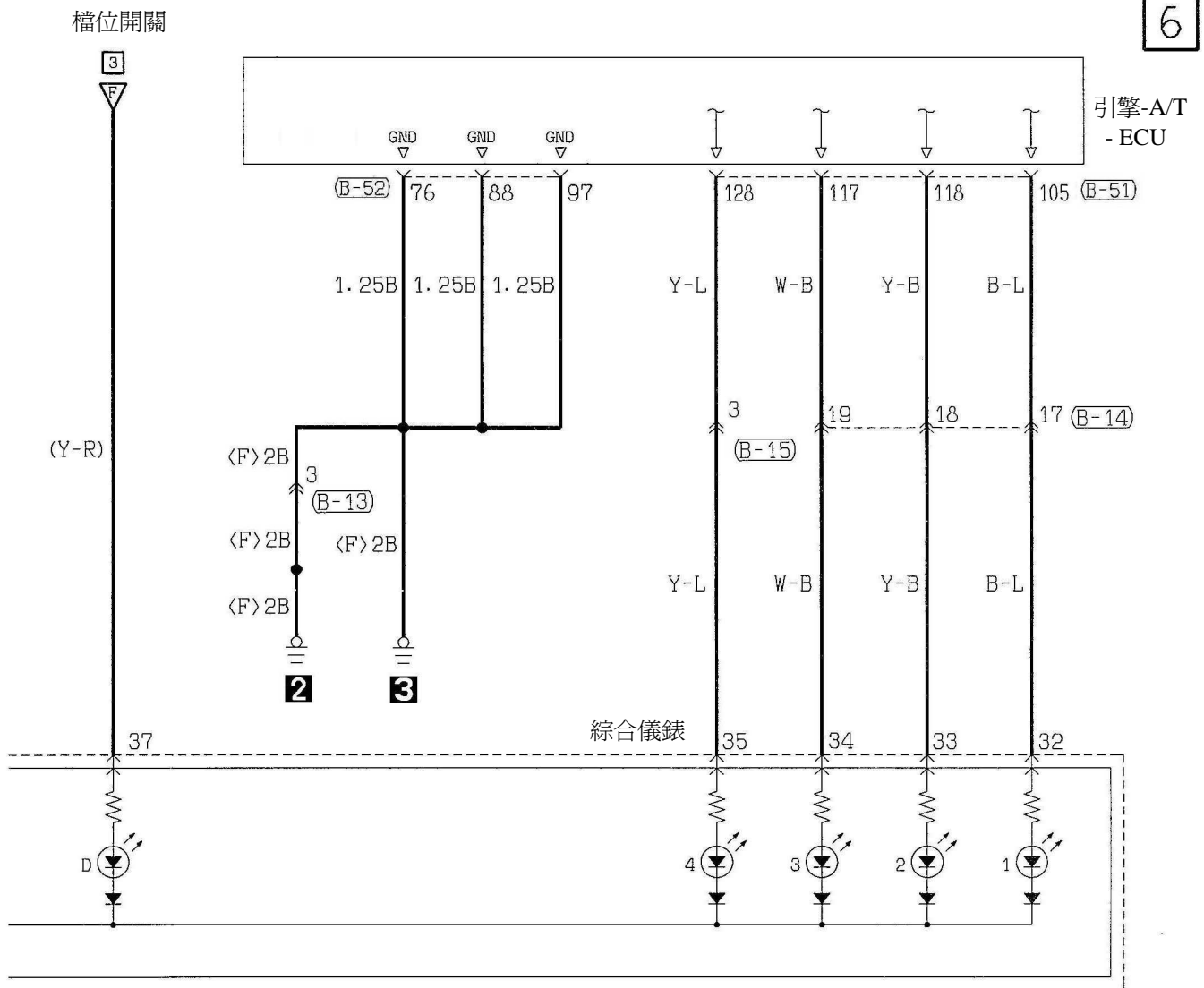

INVECS-II 4A/T

7

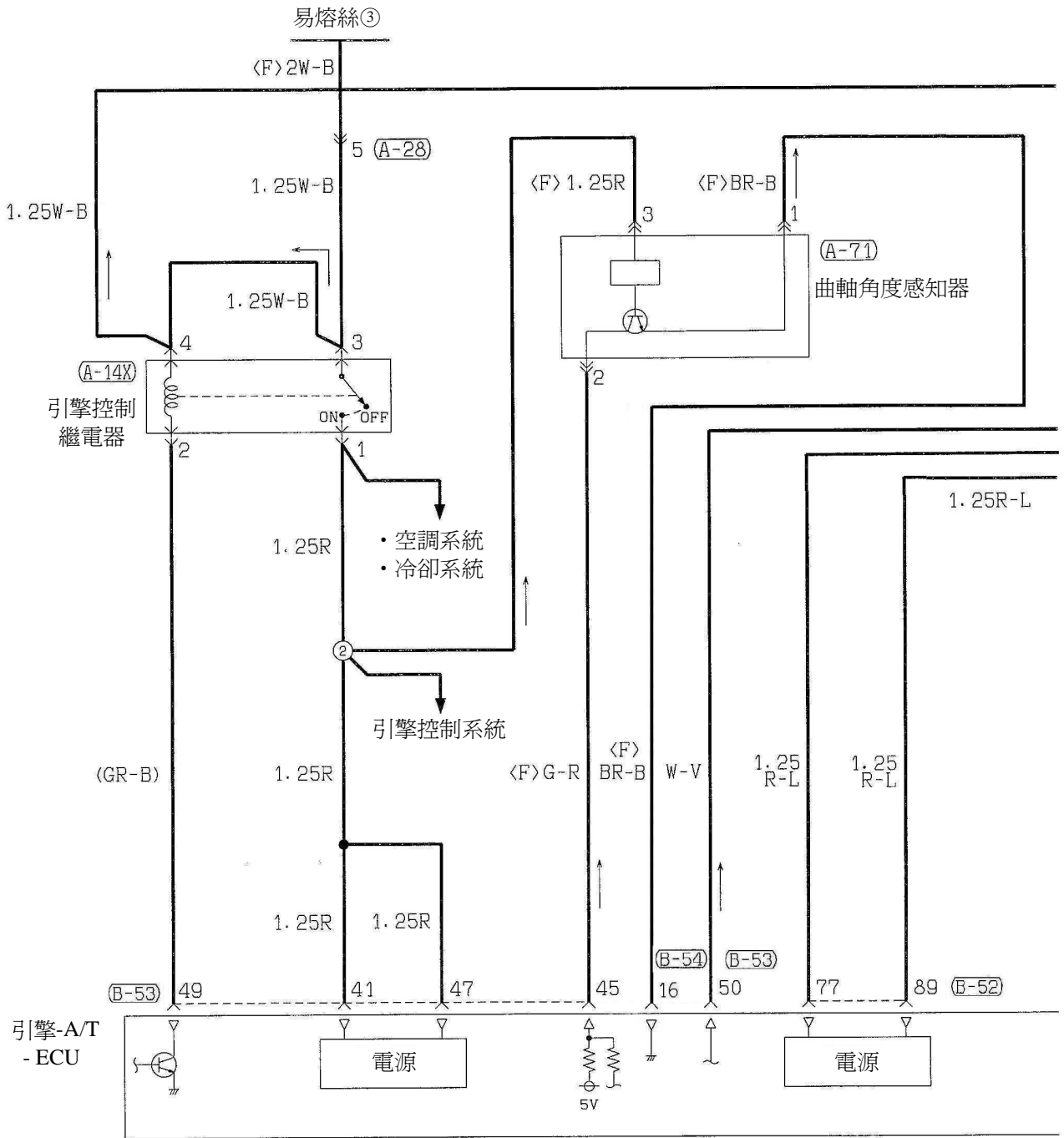

(A-12X)

1	2
3	4

(A-14X)

1	2
3	4

(A-28)

1	2	3	4	5	6	7
8	9	14	15	10	11	
12	13			16	17	

(A-71) MU802603

1	2
3	

(A-80) (MU802362)

1	2	3	4	5	6
7	8	9	10		

(B-51)

101	102	103	104		105	106	107					
108	109	110	111	112	113	114	115	116	117	118	119	120
121	122	123	124	125		126	127	128		129	130	

(B-52)

71	72	73	74			75	76	77				
78	79	80	81	82	83	84	85	86	87	88	89	
90	91	92	93	94		95	96		97	98		

INVECS-II 4A/T

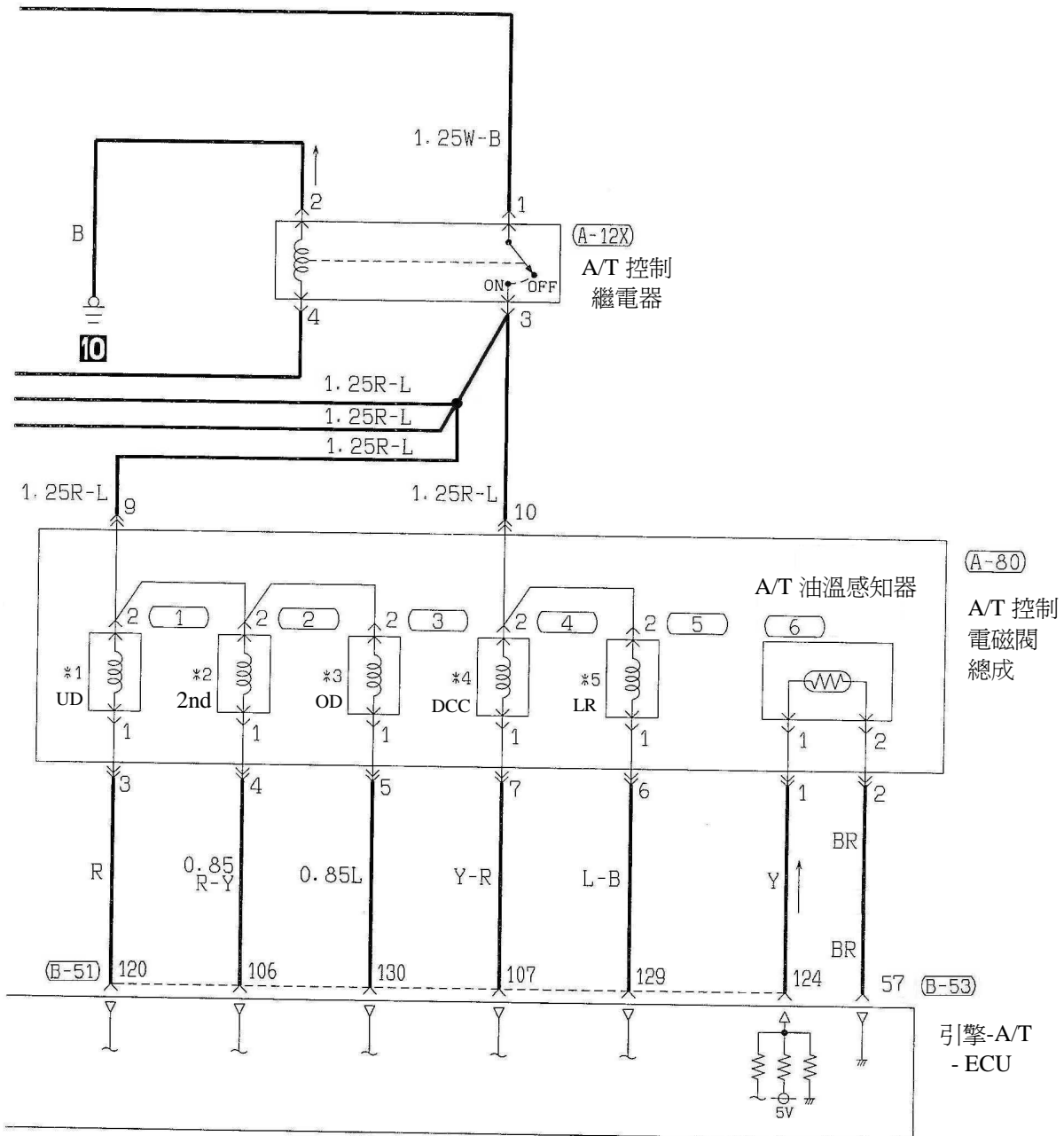

(B-53)

41	42	43		44	45	46
47	48	49	50	51	52	53
54	55	56	57	58	59	60
61	62	63	64	65	66	



MU802333

INVECS-II 4A/T

9

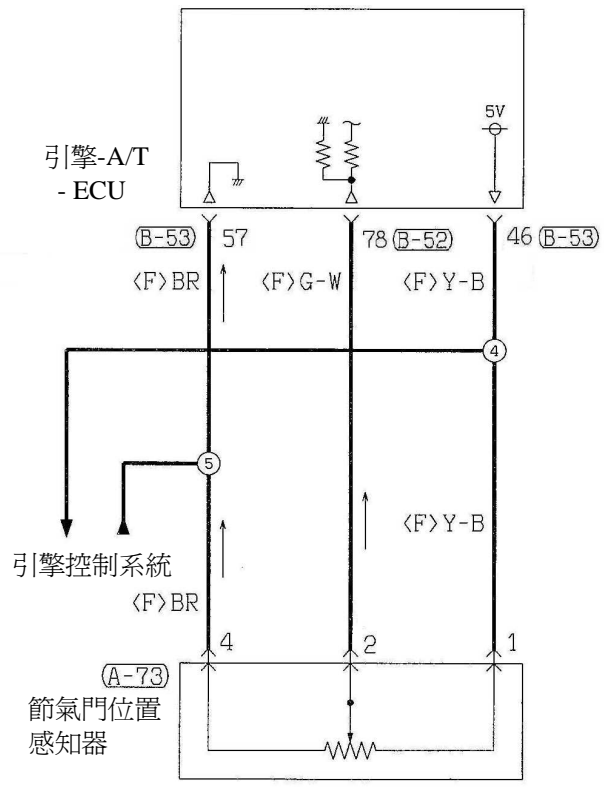

(A-73)	(B-10) (MU803772)	(B-11) (MU803771)	(B-51)	(B-52)	(B-53)
1 2 3 4	51 52 53 54 55 56 57 58 59 60 61 62 63 64 65 66 67 68 69 70 71 72	31 32 33 34 35 36 37 38 39 40 41 42 43 44 45 46	101 102 103 104 105 106 107 108 109 110 111 112 113 114 115 116 117 118 119 120 121 122 123 124 125 126 127 128 129 130	71 72 73 74 75 76 77 78 79 80 81 82 83 84 85 86 87 88 89 90 91 92 93 94 95 96 97 98	41 42 43 44 45 46 47 48 49 50 51 52 53 54 55 56 57 58 59 60 61 62 63 64 65 66

頭燈

1

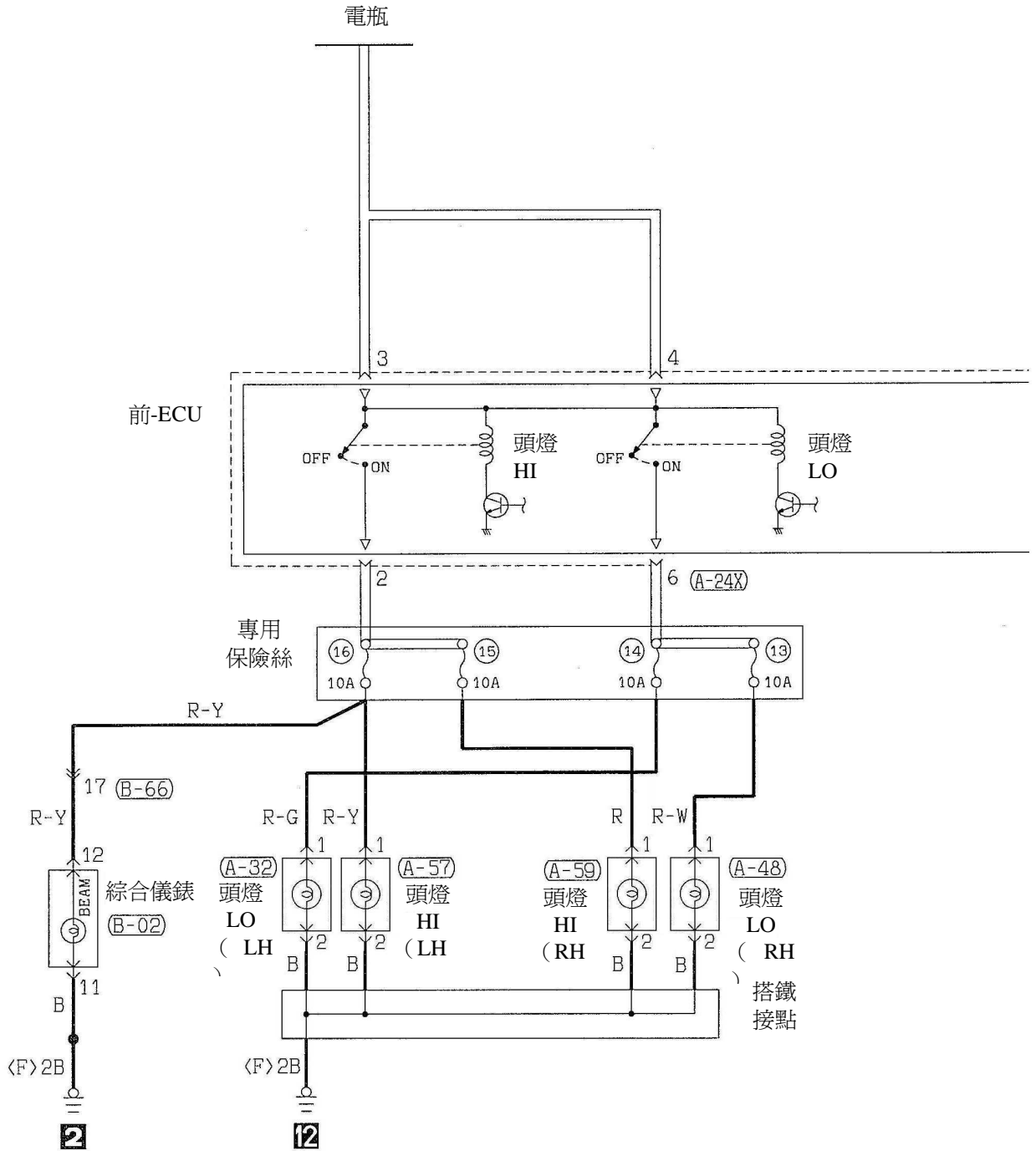

(A-24X)

1	2	3	4	5	6	7	8	9	10	11
---	---	---	---	---	---	---	---	---	----	----

(A-25X)

21	22	23	24	25	26	27	28	29	30	31
----	----	----	----	----	----	----	----	----	----	----

(A-32)

11	21
----	----

(A-57)

11	21
----	----

(B-02)

1	2	3	4	5	6	7	8	9	10	11	12
13											
14	15	16	17	18	19	20	21	22	23	24	25

(B-66)

1	2	3	4	5	6	7	8	9	10	11	12	13
14	15	16	17	18	19	20	21	22	23	24	25	38
26	27	28	29	30			31					
32	33	34	35		36	37						

頭燈

2

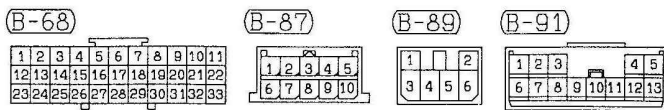
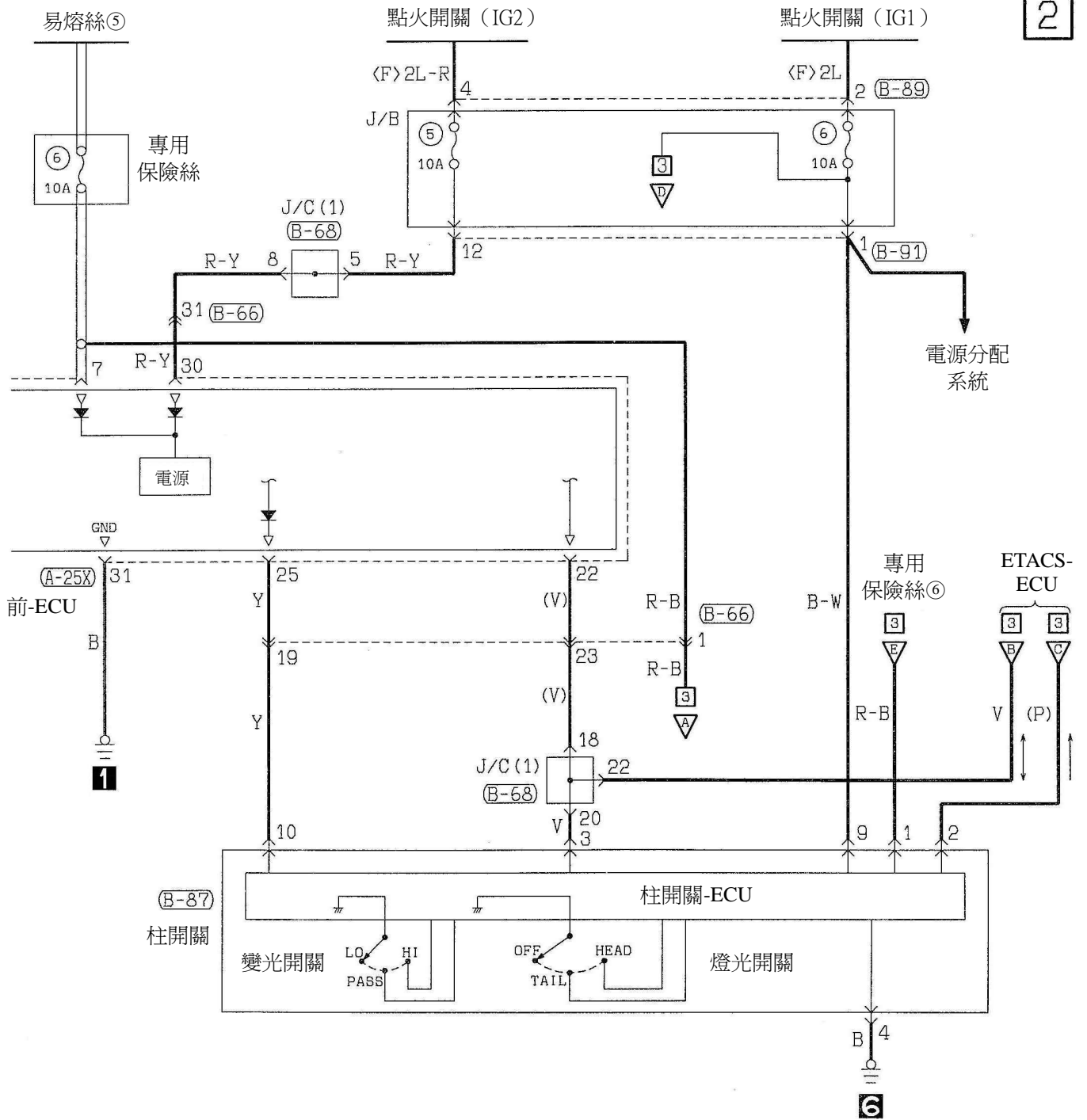

頭燈

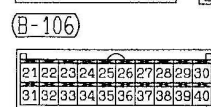
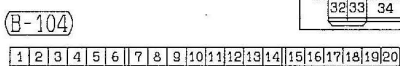
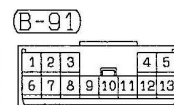
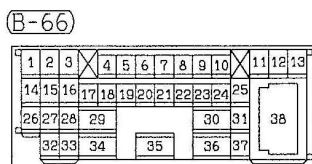
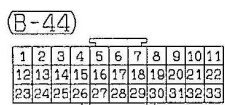
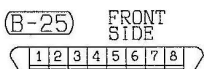
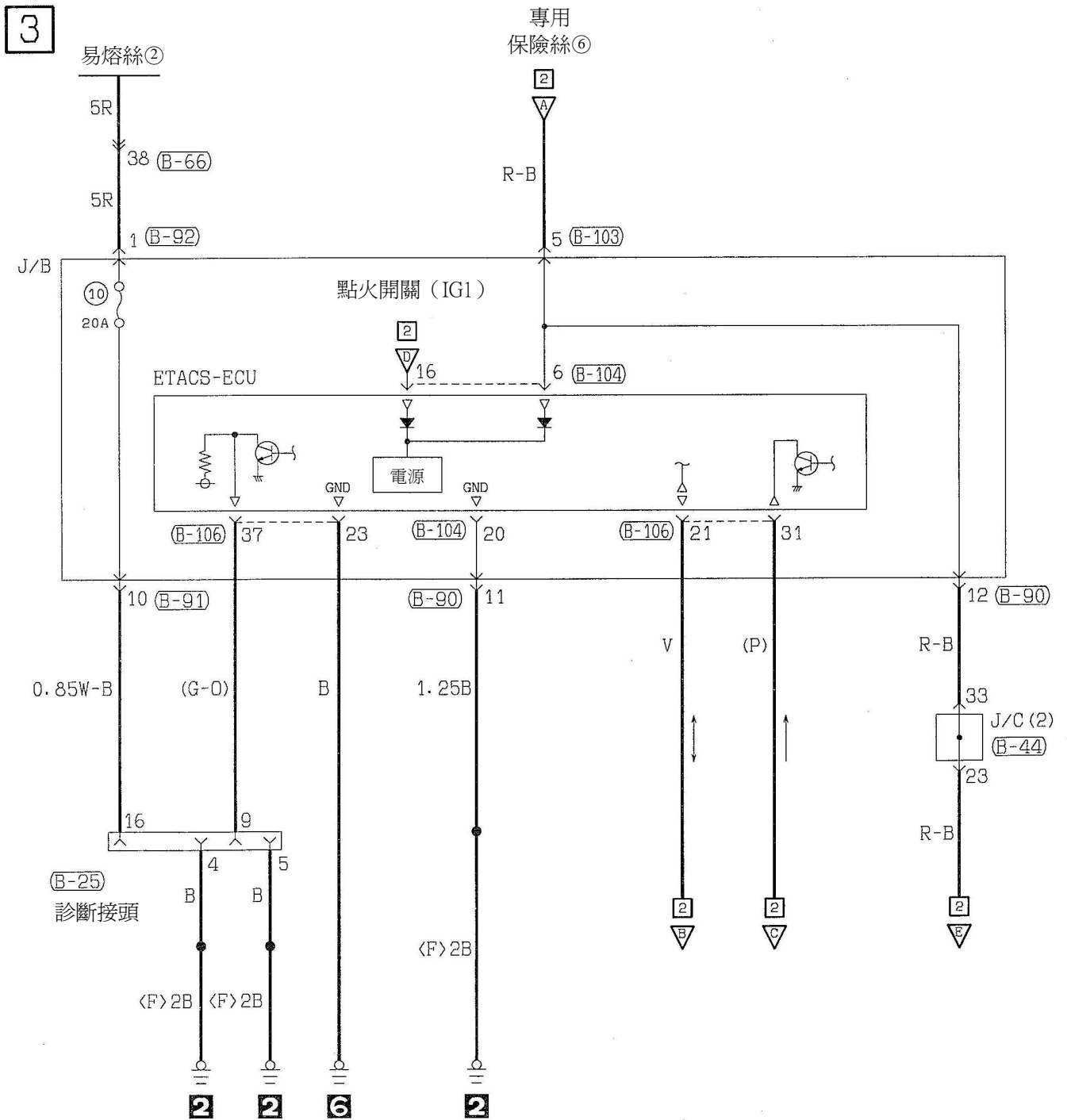

手套箱燈

1

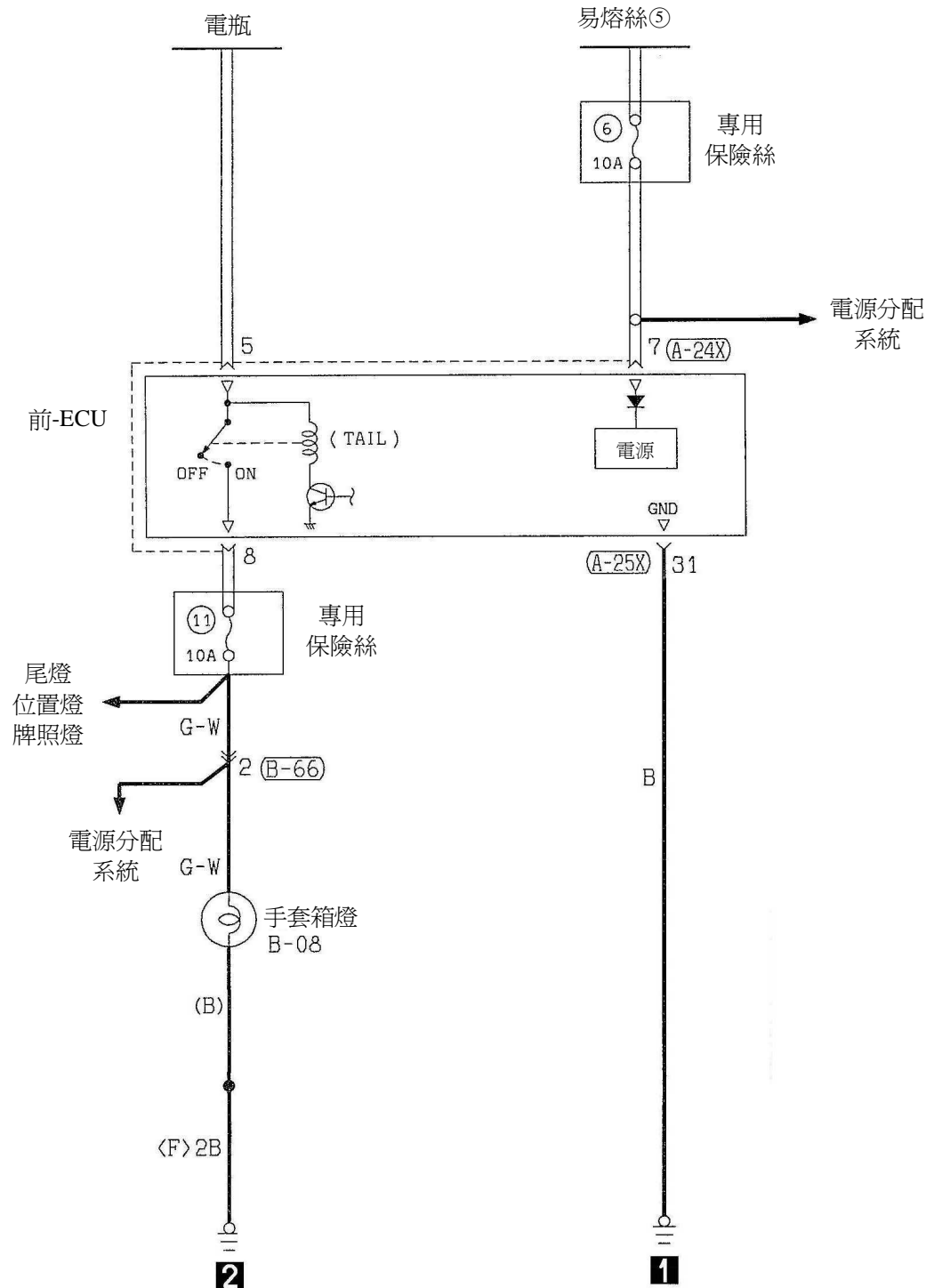

(A-24X)

1	2	3	4	5	6	7	8	9	10	11
---	---	---	---	---	---	---	---	---	----	----

(A-25X)

21	22	23	24	25	26	27	28	29	30	31
----	----	----	----	----	----	----	----	----	----	----

(B-66)

1	2	3	4	5	6	7	8	9	10	11	12	13
14	15	16	17	18	19	20	21	22	23	24	25	
26	27	28	29					30	31		38	
32	33	34		35		36	37					

54D-50 DZL 迴路圖－尾燈/位置/牌照燈

尾燈/位置燈/牌照燈

1

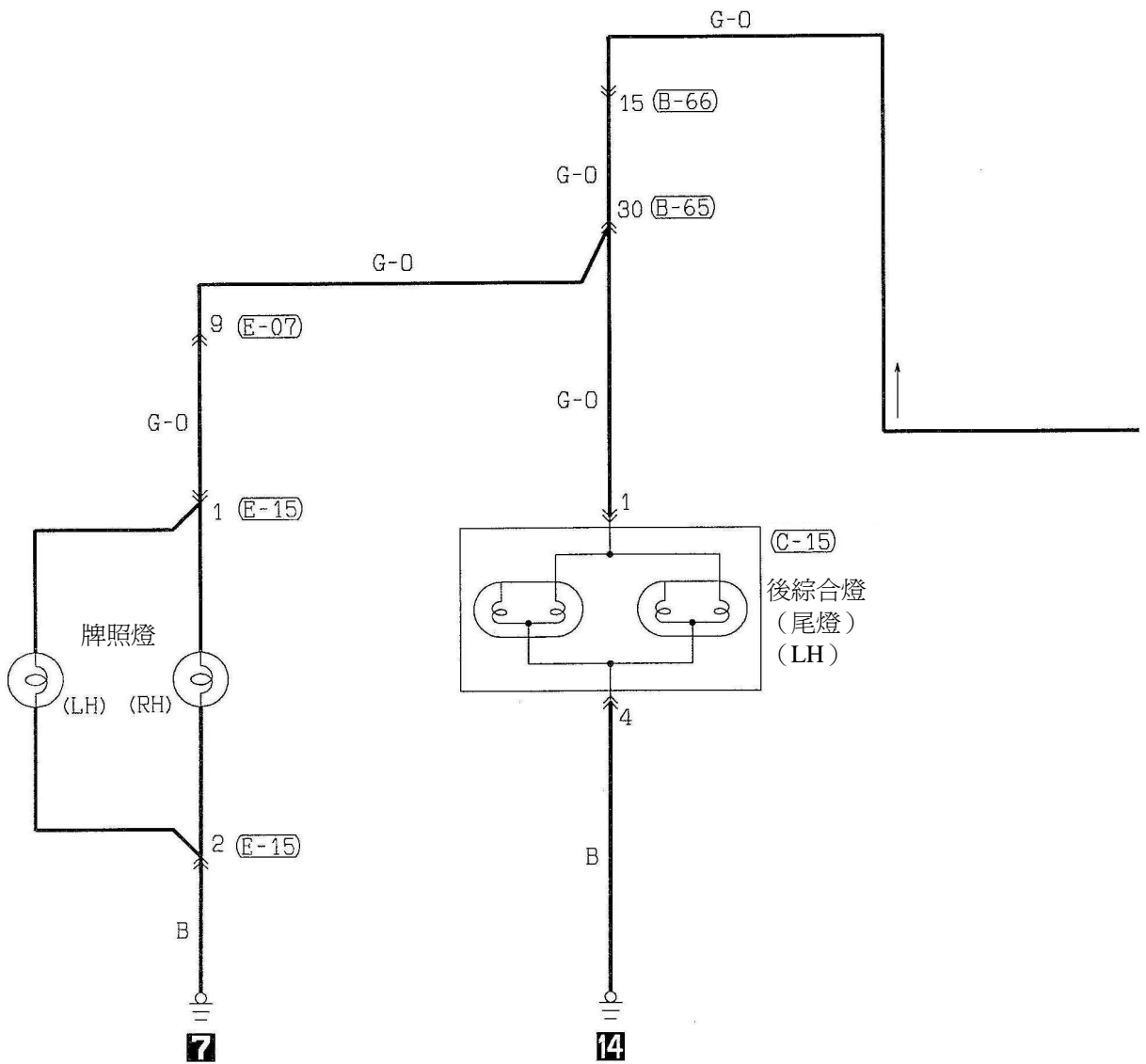

(A-24X)

1	2	3	4	5	6	7	8	9	10	11
---	---	---	---	---	---	---	---	---	----	----

(A-25X)

21	22	23	24	25	26	27	28	29	30	31
----	----	----	----	----	----	----	----	----	----	----

(A-31)

(A-46)

1	2
3	

(B-65)

1	2	3	4	5	6	7	8	9
10	11	12	13	14	15	16	17	18
19	20	21	22	23	24	25	26	27
28	29	30	31	32	33	34	35	36
37	38	39	40	41	42	43		

DZL 迴路圖－尾燈/位置燈/牌照燈 54D-51

尾燈/位置燈/牌照燈

2

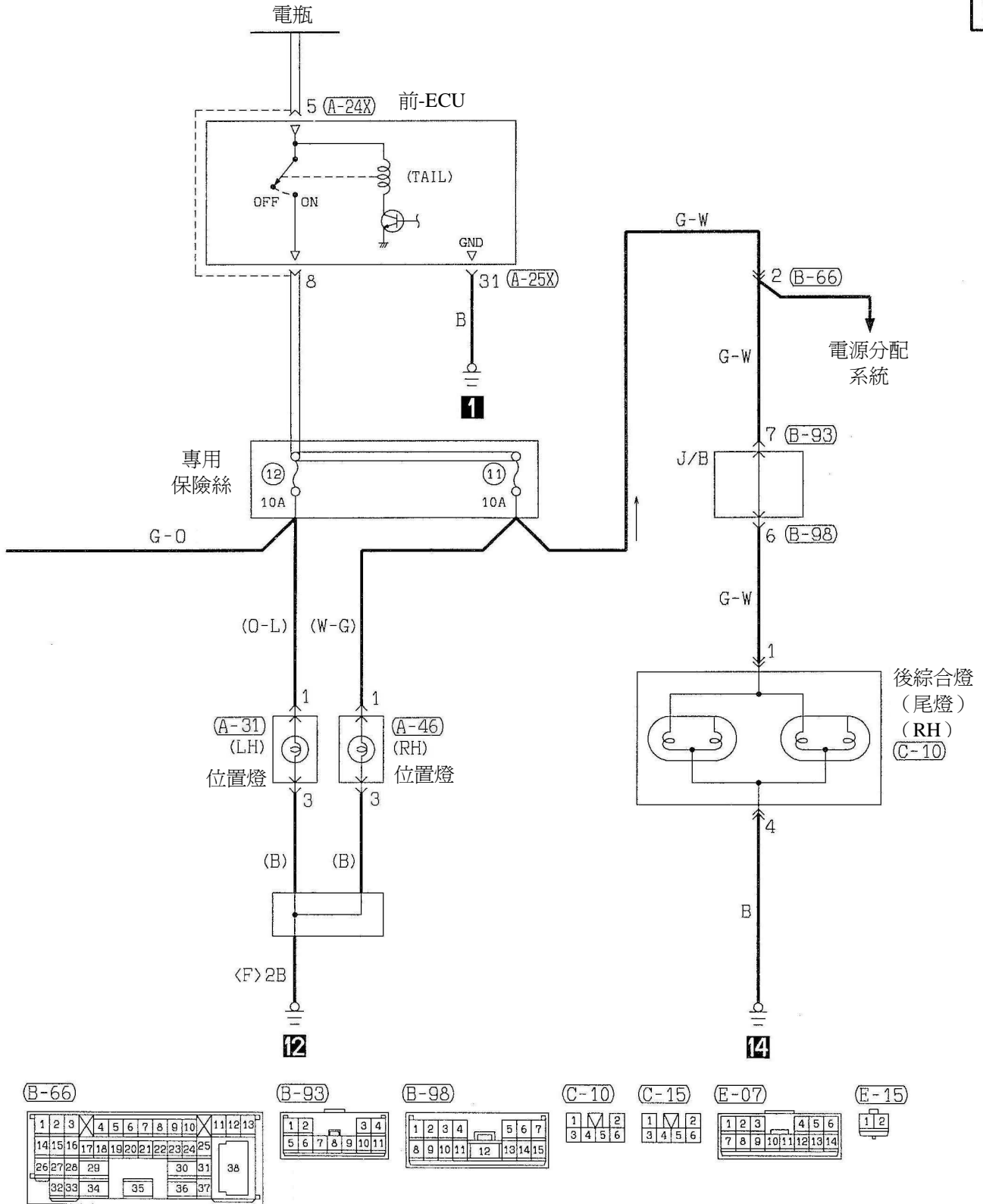

54D-52 DZL 迴路圖－尾燈/位置/牌照燈

尾燈/位置燈/牌照燈

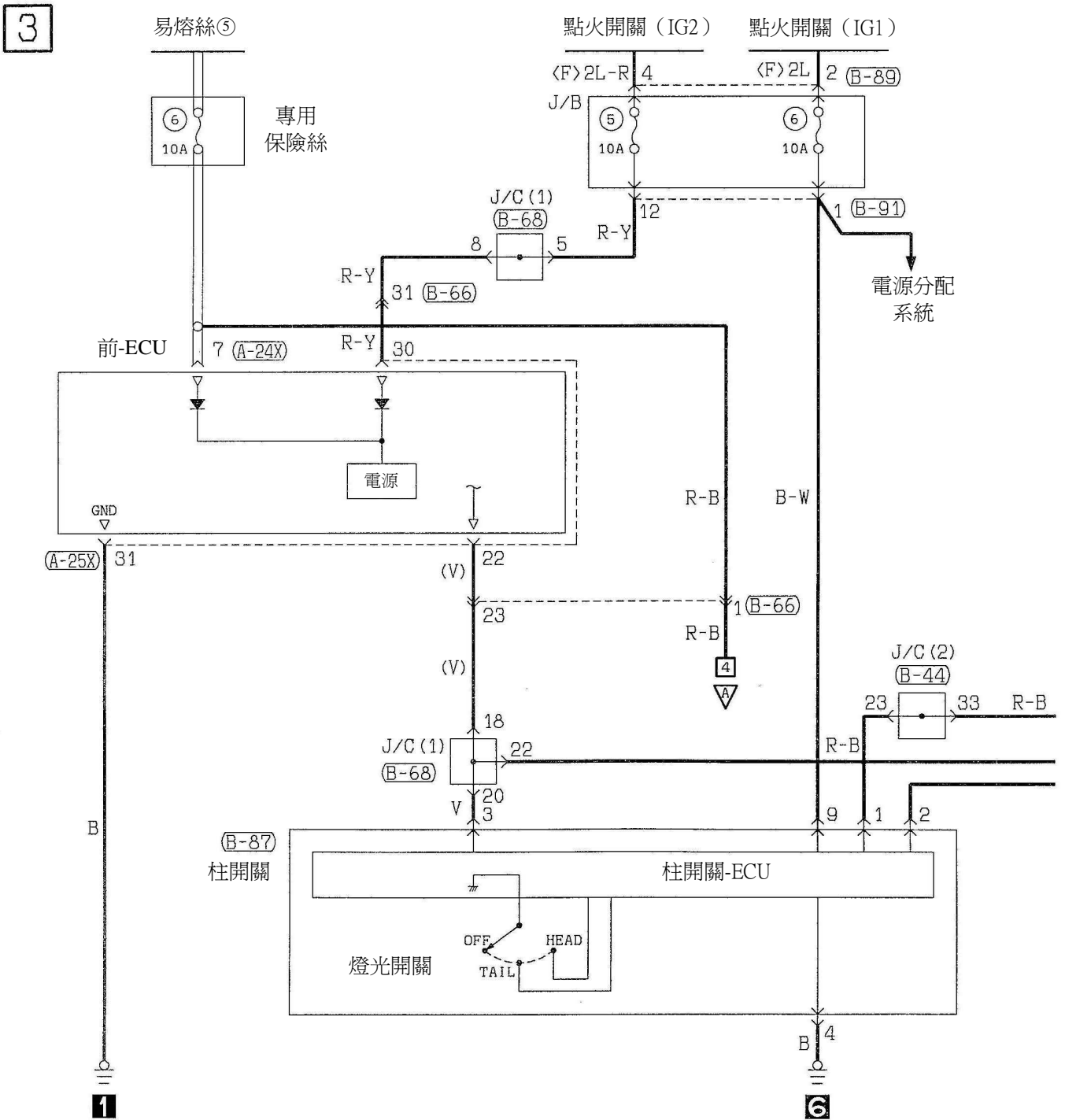

(A-24X)

1	2	3	4	5	6	7	8	9	10	11
---	---	---	---	---	---	---	---	---	----	----

(A-25X)

21	22	23	24	25	26	27	28	29	30	31
----	----	----	----	----	----	----	----	----	----	----

(B-25)

1	2	3	4	5	6	7	8
9	10	11	12	13	14	15	16

(B-44)

1	2	3	4	5	6	7	8	9	10	11
12	13	14	15	16	17	18	19	20	21	22
23	24	25	26	27	28	29	30	31	32	33

(B-66)

1	2	3	4	5	6	7	8	9	10	11	12	13
14	15	16	17	18	19	20	21	22	23	24	25	
26	27	28	29					30	31			38
32	33	34		35				36	37			

(B-104)

1	2	3	4	5	6	7	8	9	10	11	12	13	14	15	16	17	18	19	20
---	---	---	---	---	---	---	---	---	----	----	----	----	----	----	----	----	----	----	----

(B-106)

21	22	23	24	25	26	27	28	29	30
31	32	33	34	35	36	37	38	39	40

DZL 迴路圖－尾燈/位置燈/牌照燈 54D-53

尾燈/位置燈/牌照燈

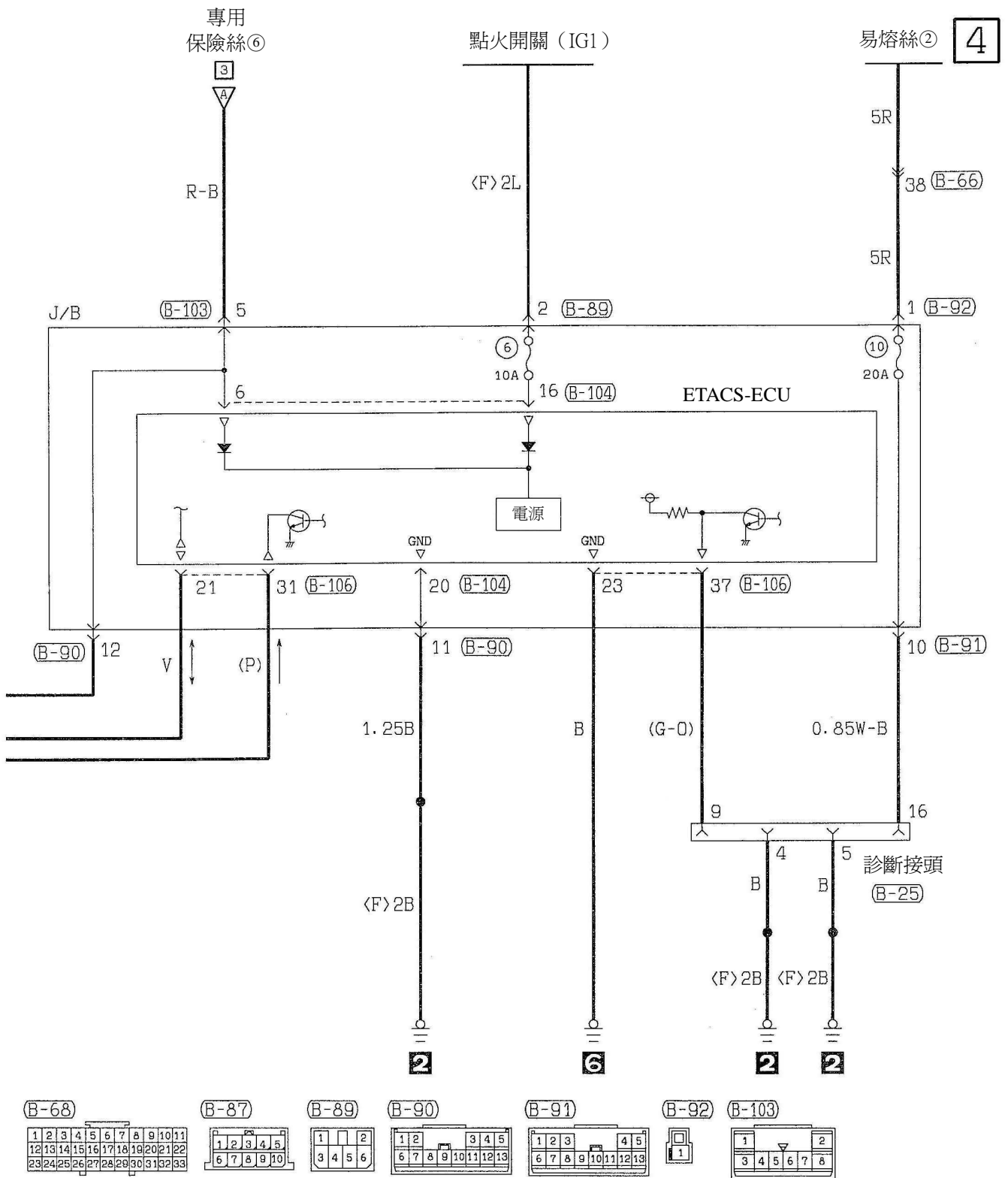

霧燈

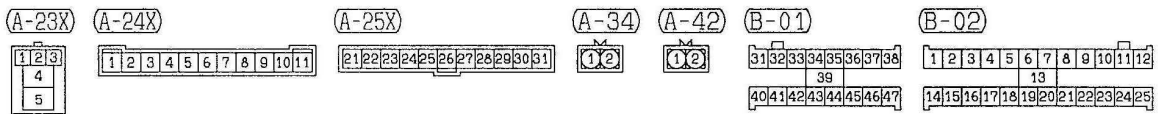
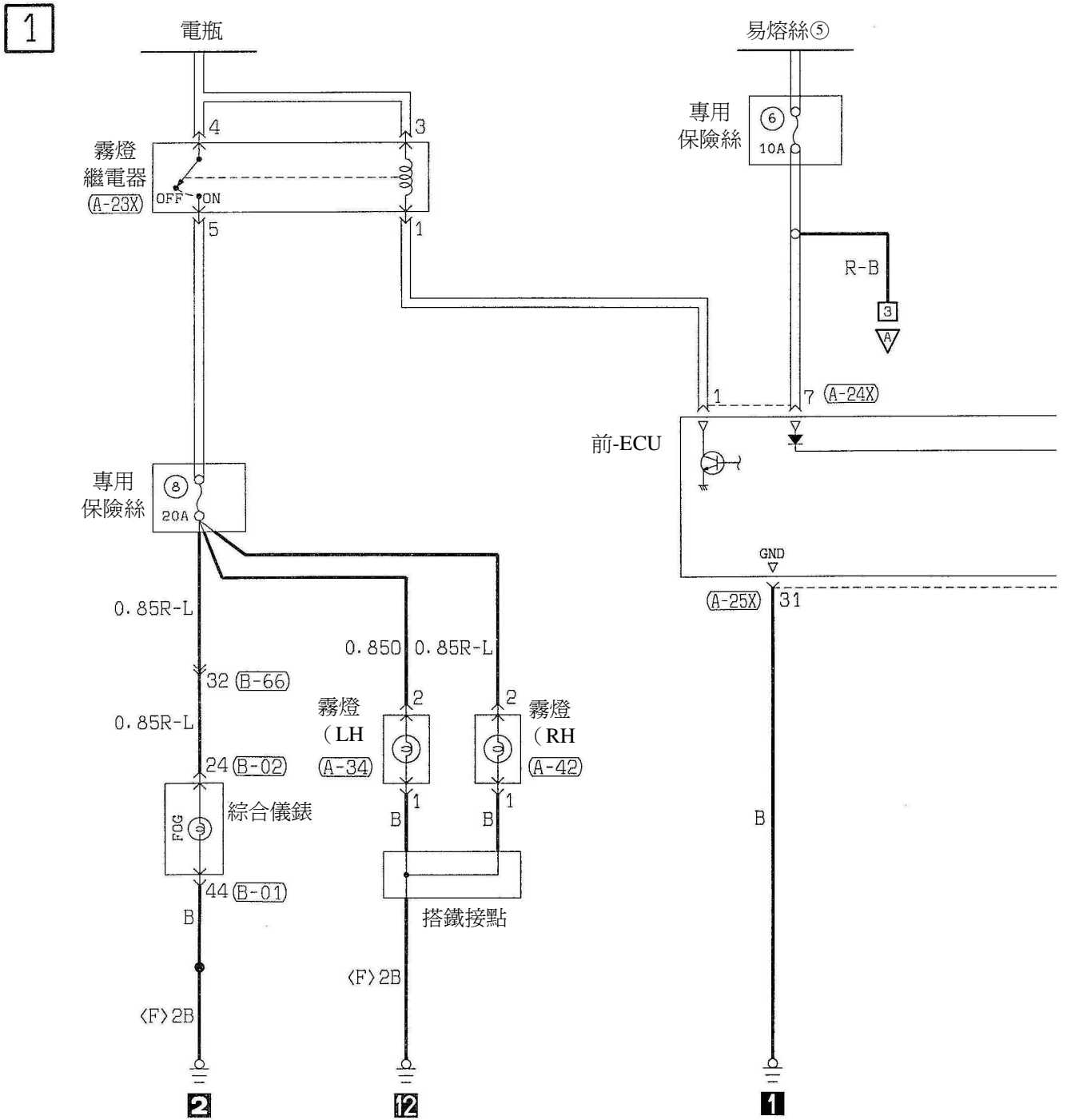

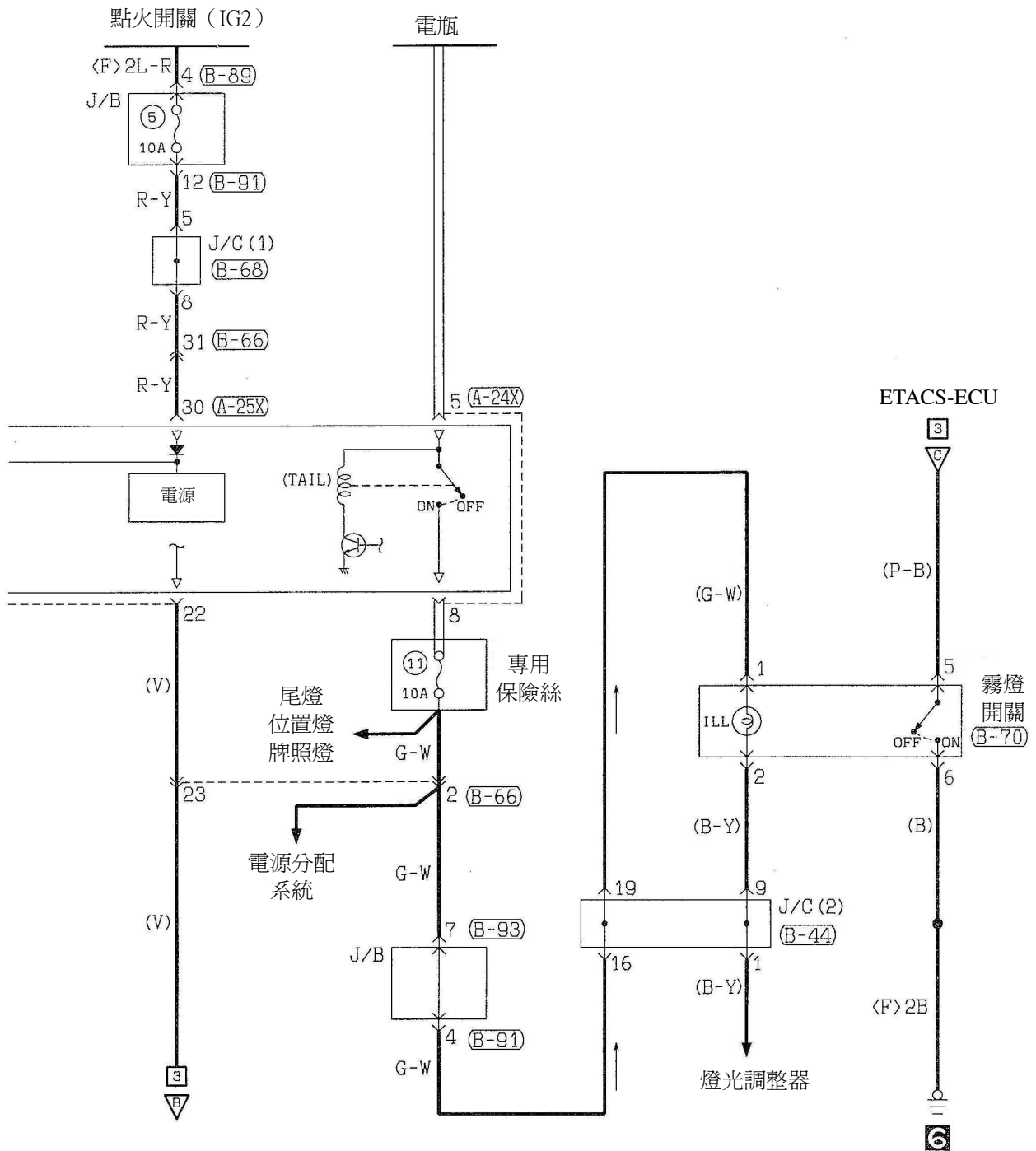

(B-44)

1	2	3	4	5	6	7	8	9	10	11
12	13	14	15	16	17	18	19	20	21	22
23	24	25	26	27	28	29	30	31	32	33

(B-66)

1	2	3	4	5	6	7	8	9	10	11	12	13
14	15	16	17	18	19	20	21	22	23	24	25	26
27	28	29	30	31	32	33	34	35	36	37	38	39

(B-68)

1	2	3	4	5	6	7	8	9	10	11
12	13	14	15	16	17	18	19	20	21	22
23	24	25	26	27	28	29	30	31	32	33

(B-70)

1	2
3	4
5	6

(B-89)

1	2
3	4
5	6

(B-91)

1	2	3	4	5
6	7	8	9	10
11	12	13	14	15

(B-93)

1	2	3	4
5	6	7	8
9	10	11	12

霧燈

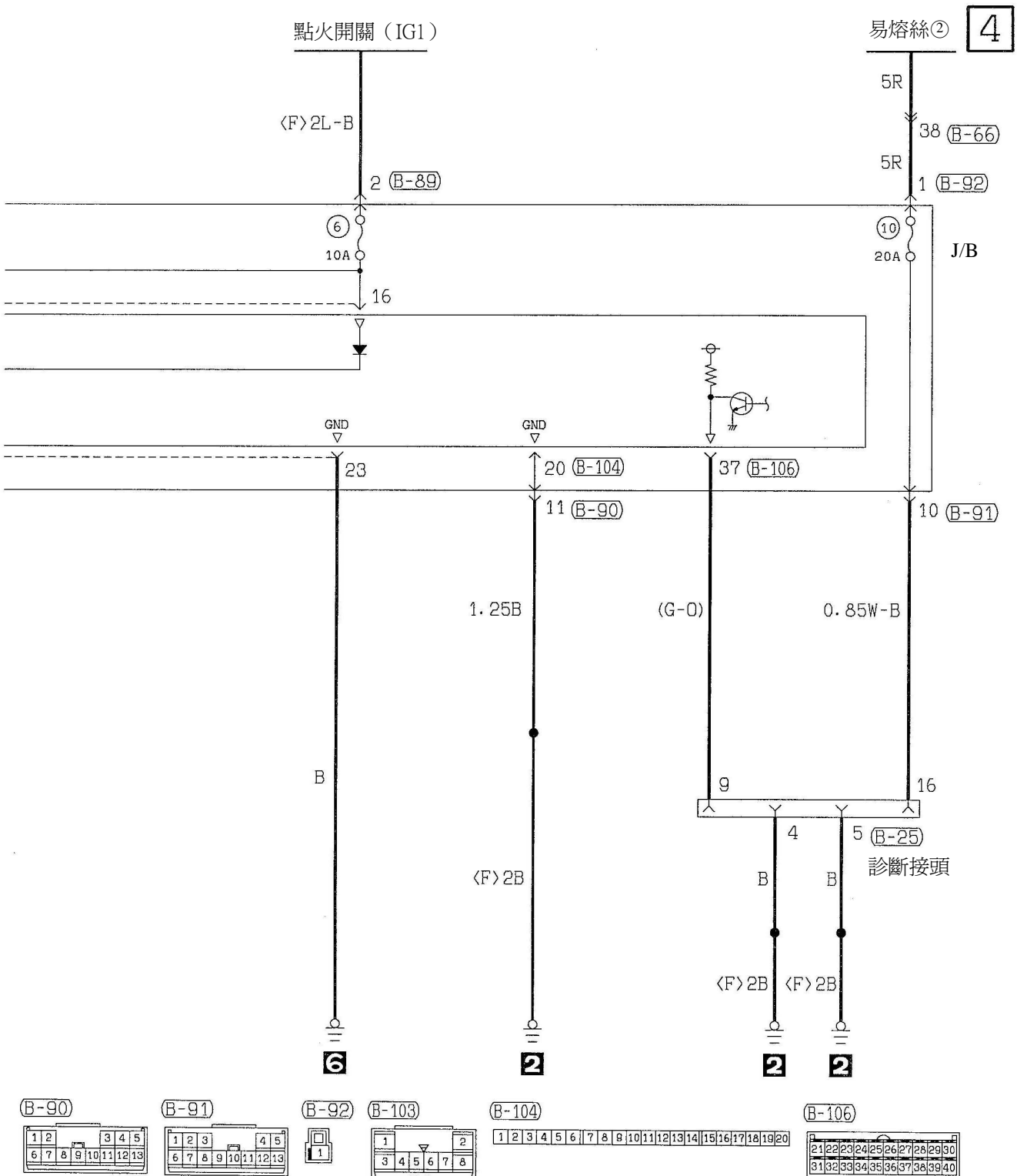

室內燈/行李廂燈

1

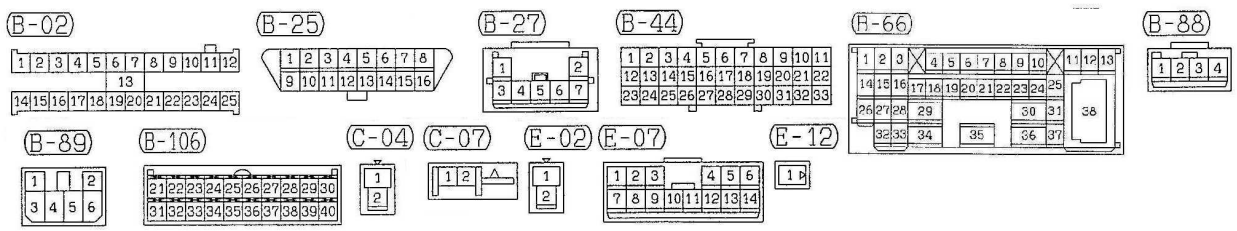
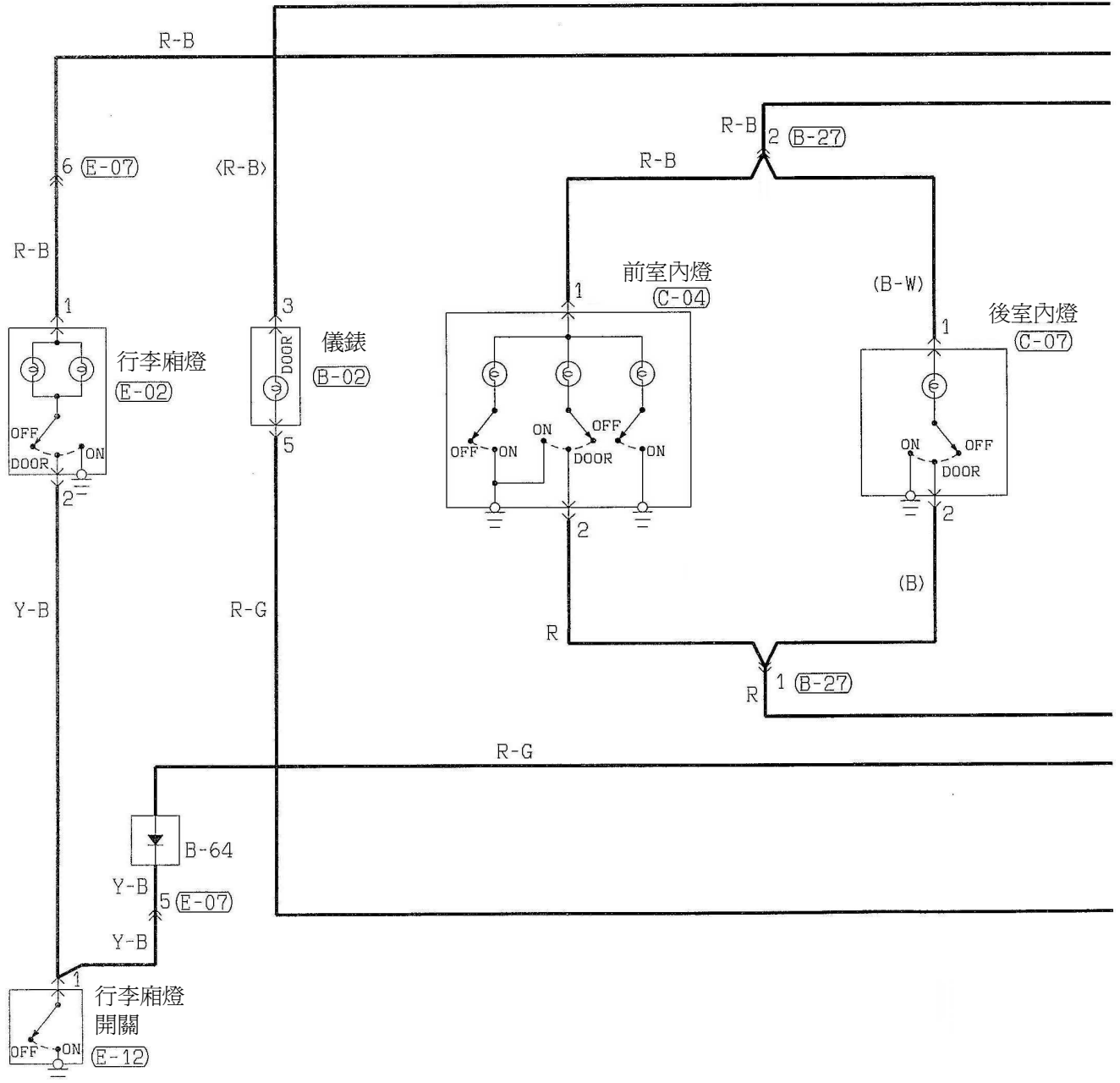

室內燈/行李廂燈

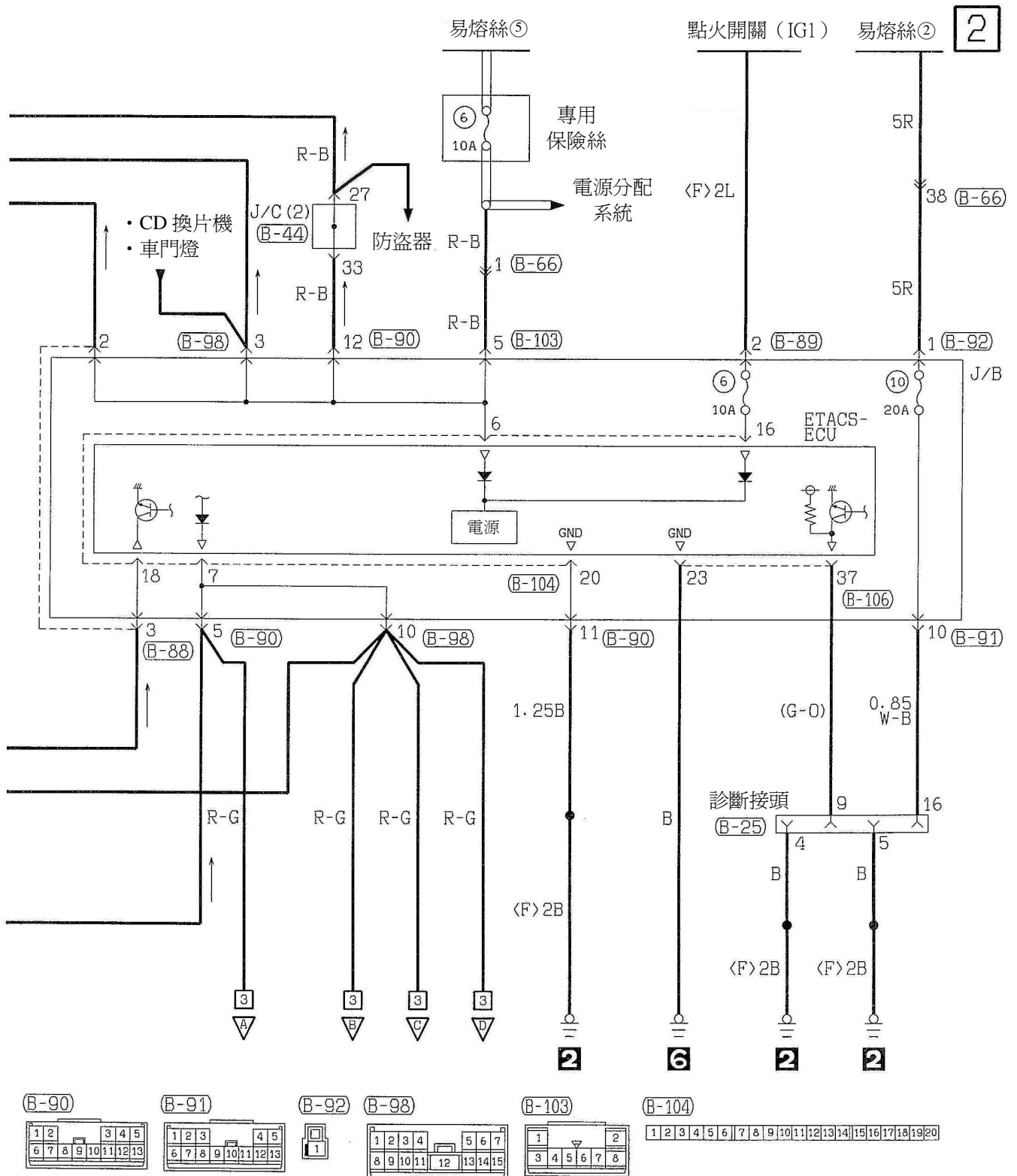

室內燈/行李廂燈

3

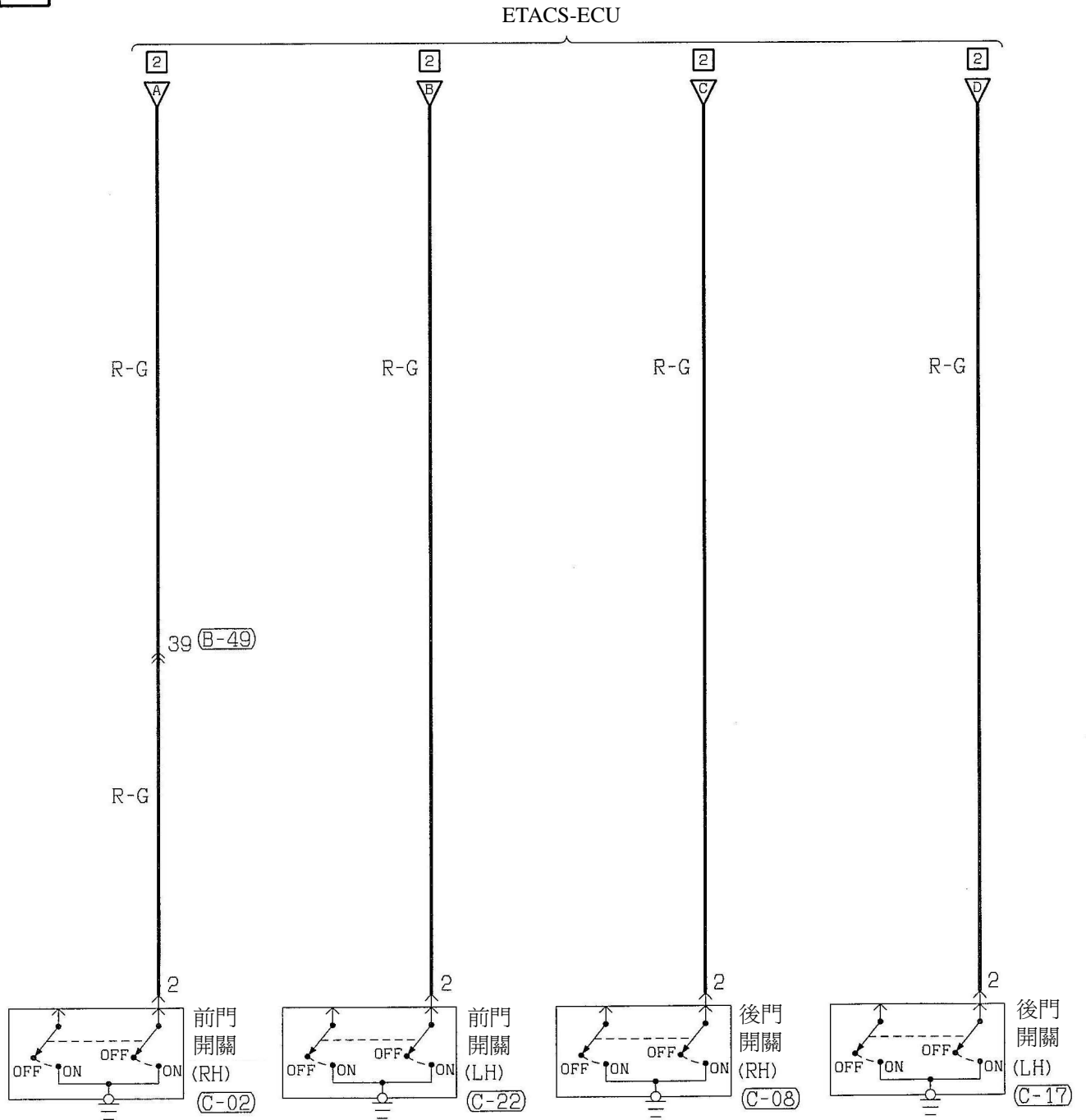

(B-49)

1	2	3	4	5	6	7	8	9			
10	11	12	13	14	15	16	17	18	19	20	21
22	23	24	25	26	27	28	29	30	31	32	33
34	35	36	37	38	39	40	41	42	43		

(C-02)

(C-08)

(C-17)

(C-22)

1	2	3
---	---	---

1	2	3
---	---	---

1	2	3
---	---	---

1	2	3
---	---	---

54D-64 DZL 迴路圖－方向燈及危險警告燈

方向燈及危險警告燈

1

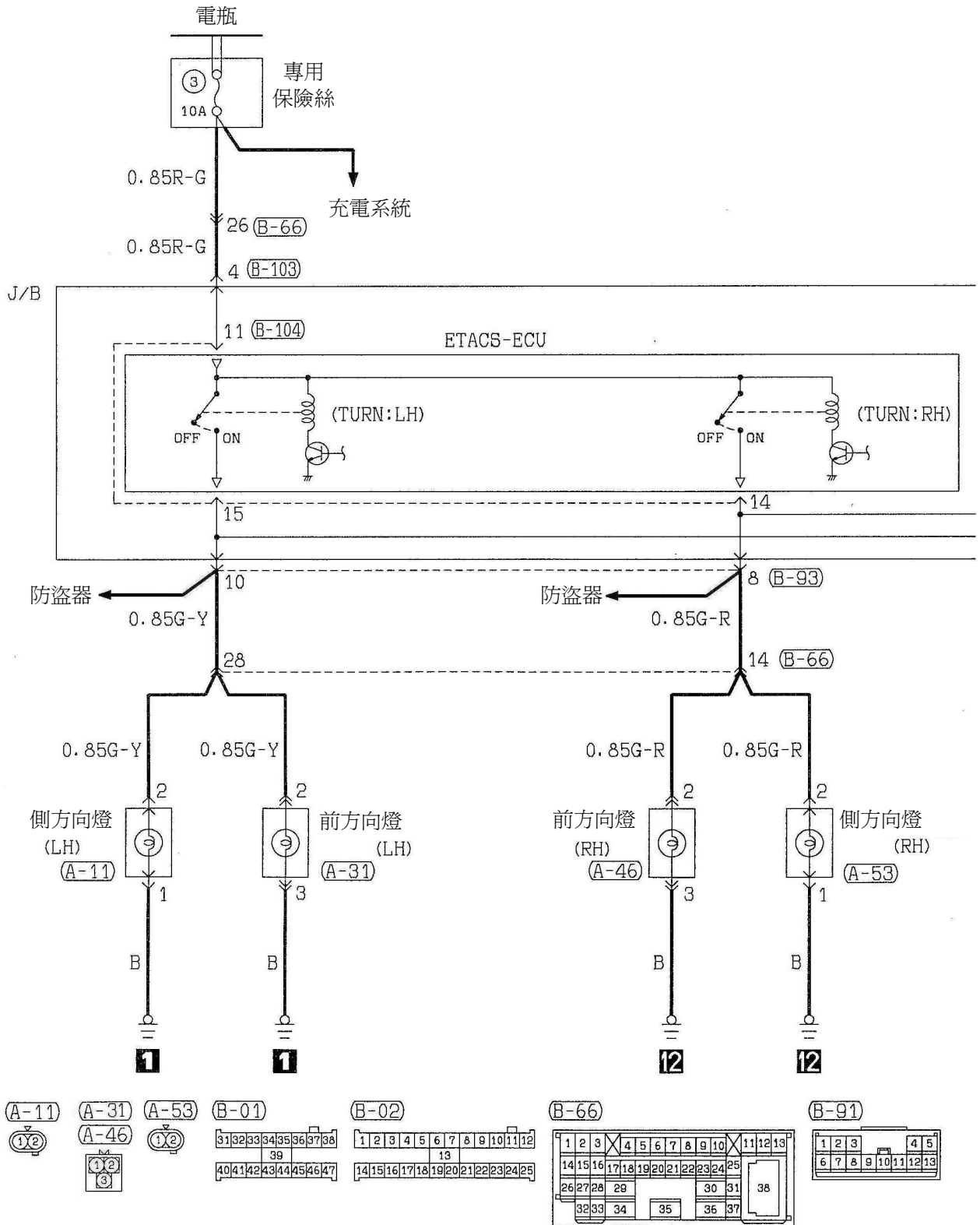

DZL 迴路圖－方向燈及危險警告燈54D-65

方向燈及危險警告燈

2

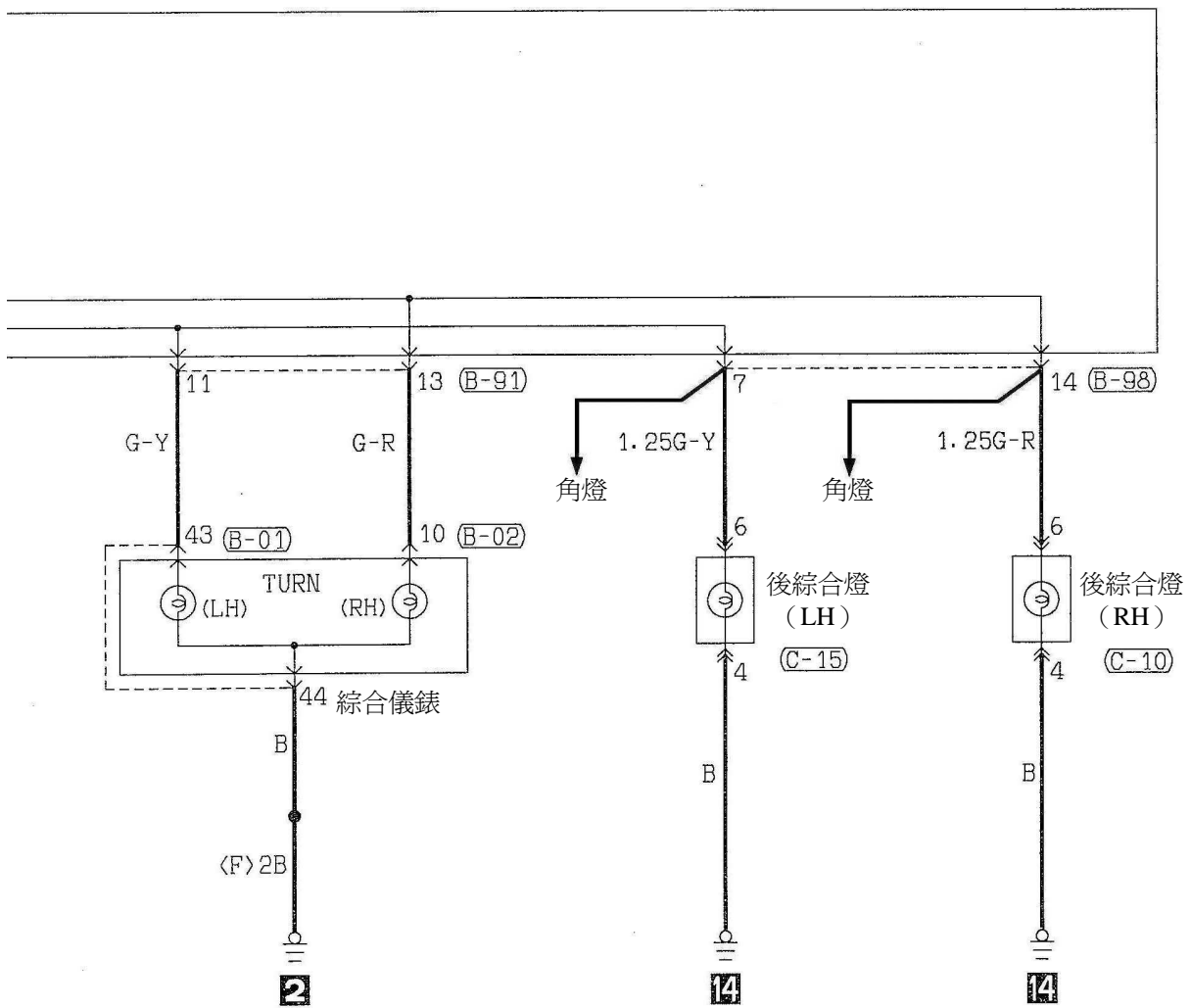

(B-93)

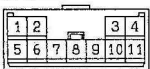

(B-98)

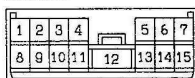

(B-103)

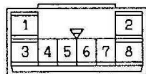

(B-104)

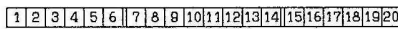

(C-10)

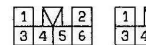

(C-15)



54D-66 DZL 迴路圖－方向燈及危險警告燈

方向燈及危險警告燈

3

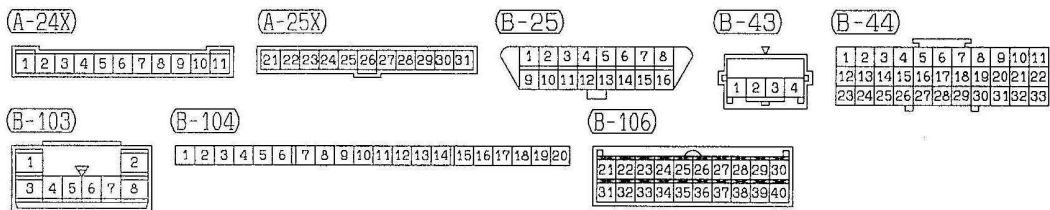
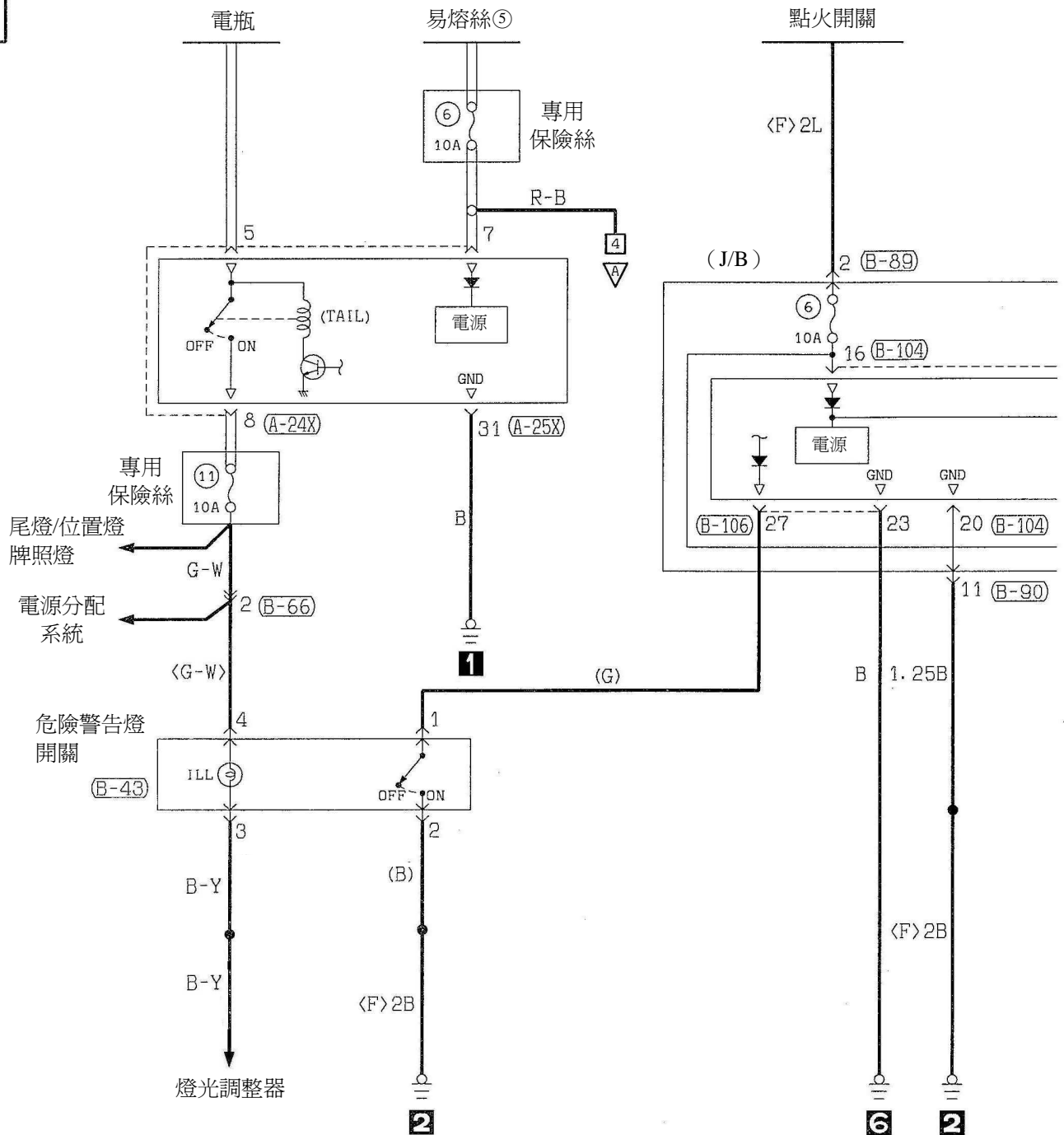

DZL 迴路圖－方向燈及危險警告燈54D-67

方向燈及危險警告燈

4

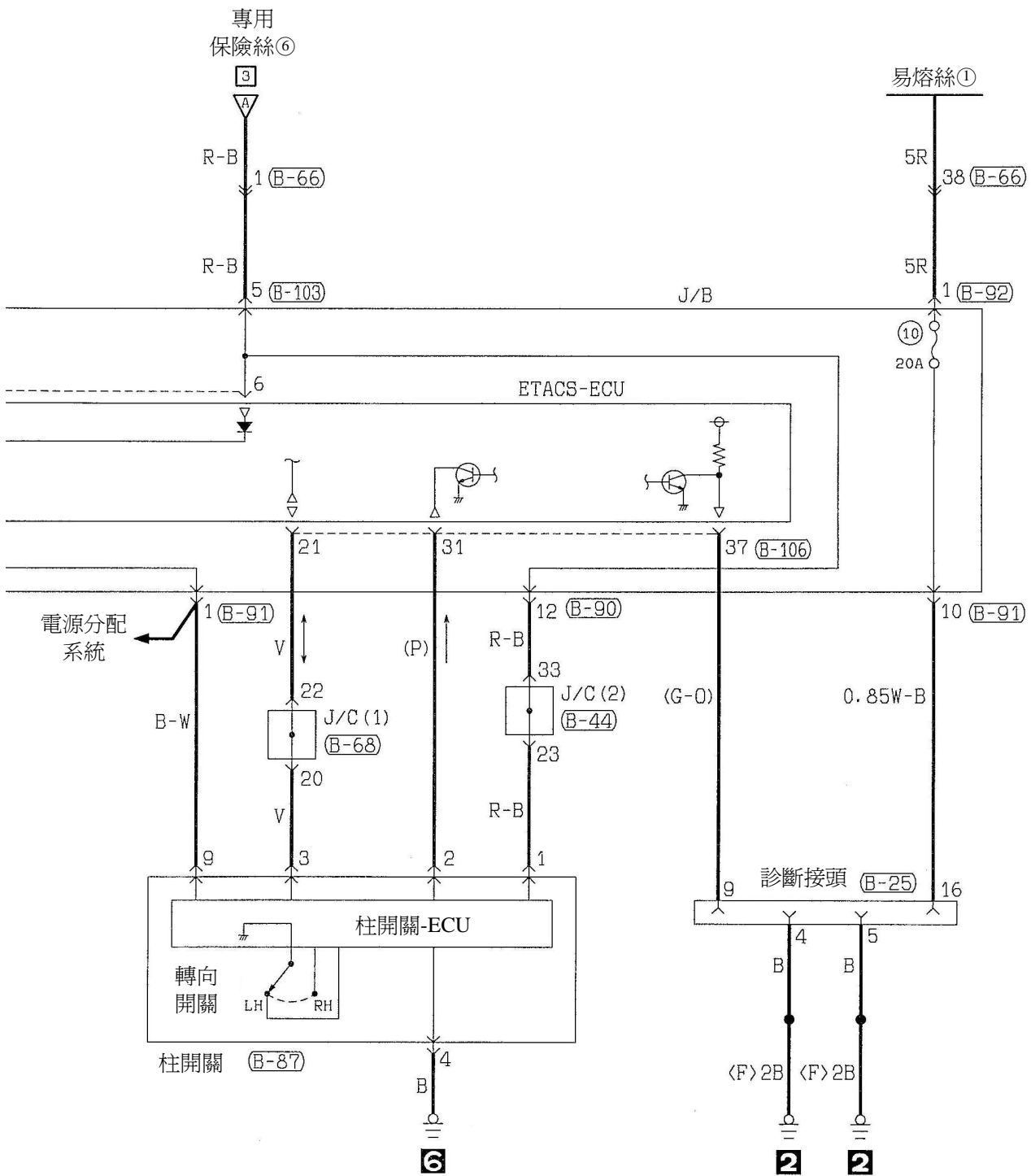

(B-66)

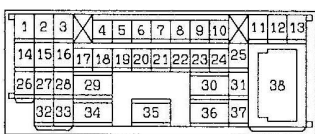

(B-68)

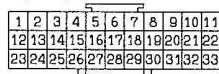

(B-87)

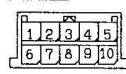

(B-89)



(B-90)

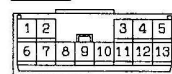

(B-91)

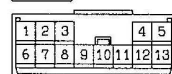

(B-92)



角燈

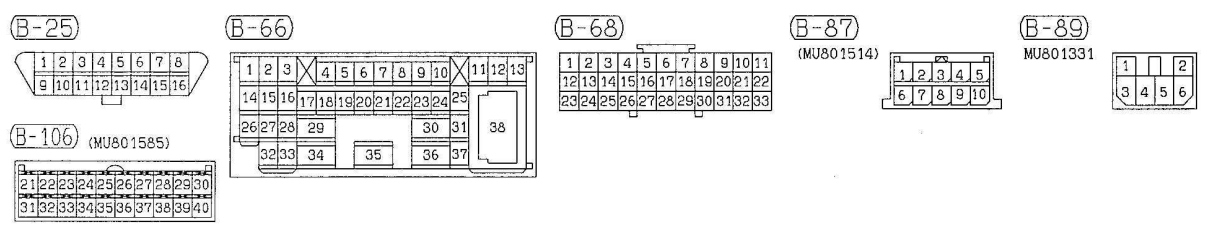
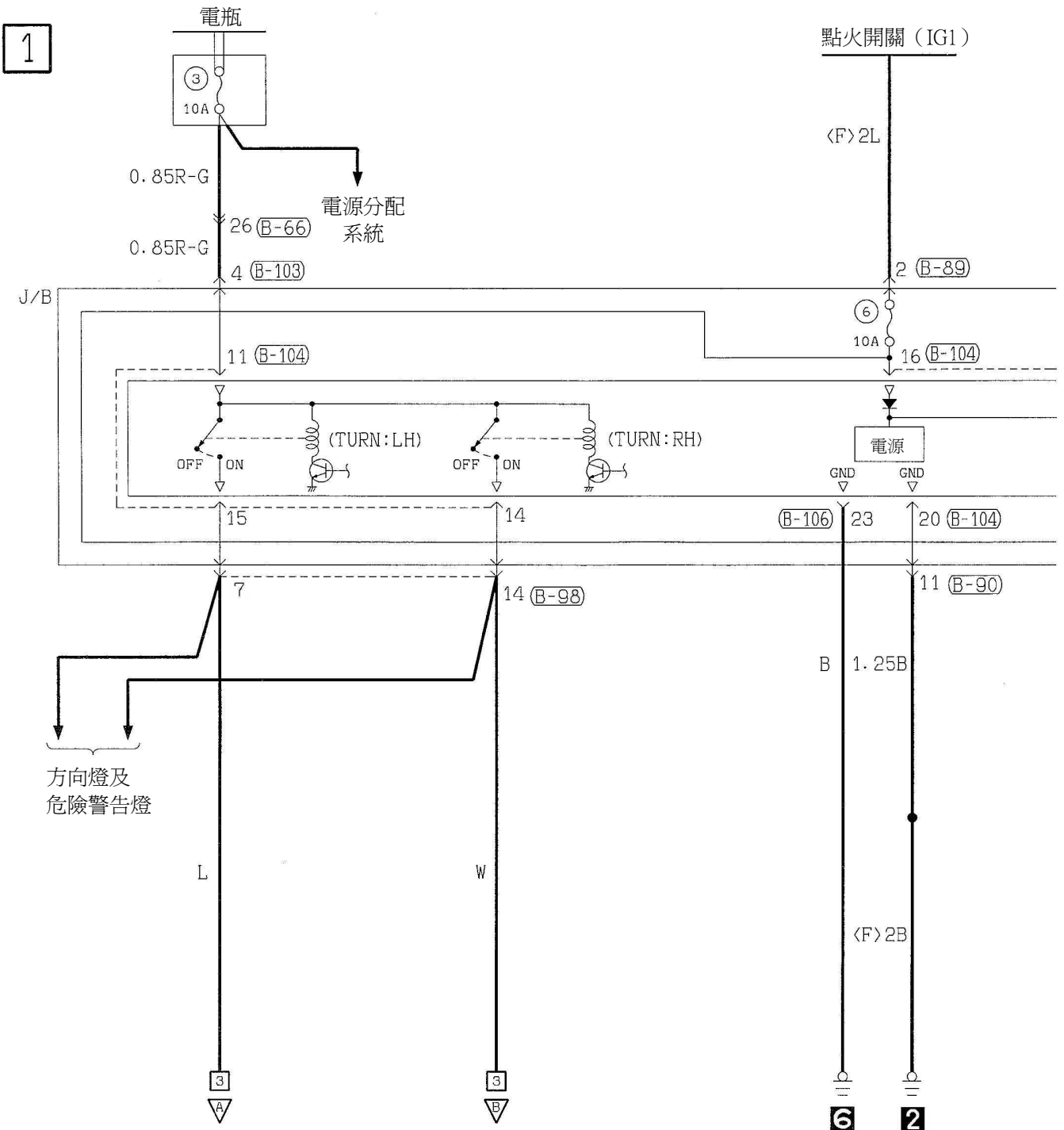

角燈

2

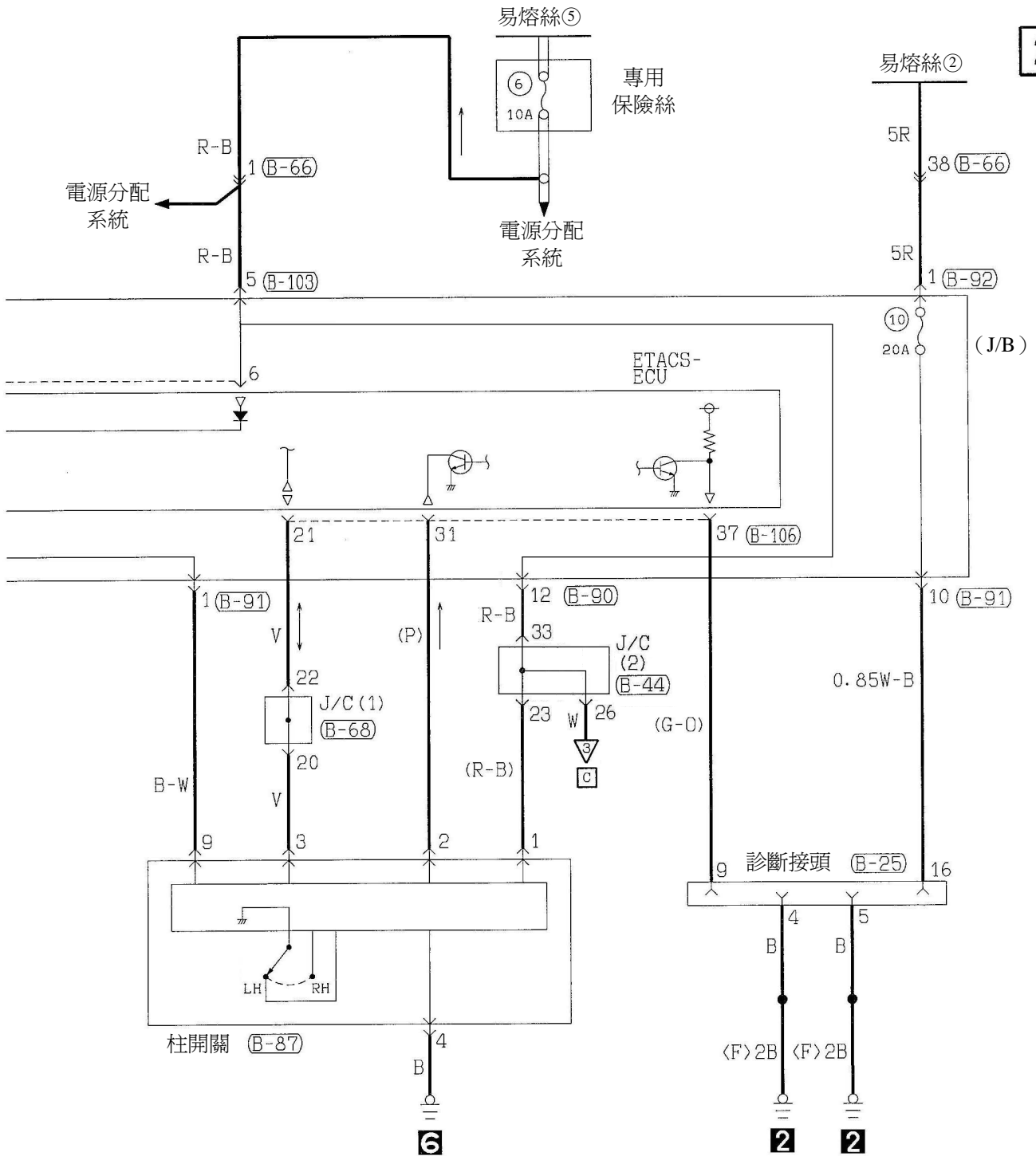

(B-44)

1	2	3	4	5	6	7	8	9	10	11
12	13	14	15	16	17	18	19	20	21	22
23	24	25	26	27	28	29	30	31	32	33

(B-90)

1	2	3	4	5
6	7	8	9	10
11	12	13		

(B-91)

1	2	3	4	5
6	7	8	9	10
11	12	13		

(B-92)

1

(B-103)

1	2
3	4
5	6
7	8

(B-104)

1	2	3	4	5	6	7	8	9	10	11	12	13	14	15	16	17	18	19	20
---	---	---	---	---	---	---	---	---	----	----	----	----	----	----	----	----	----	----	----

角燈

3

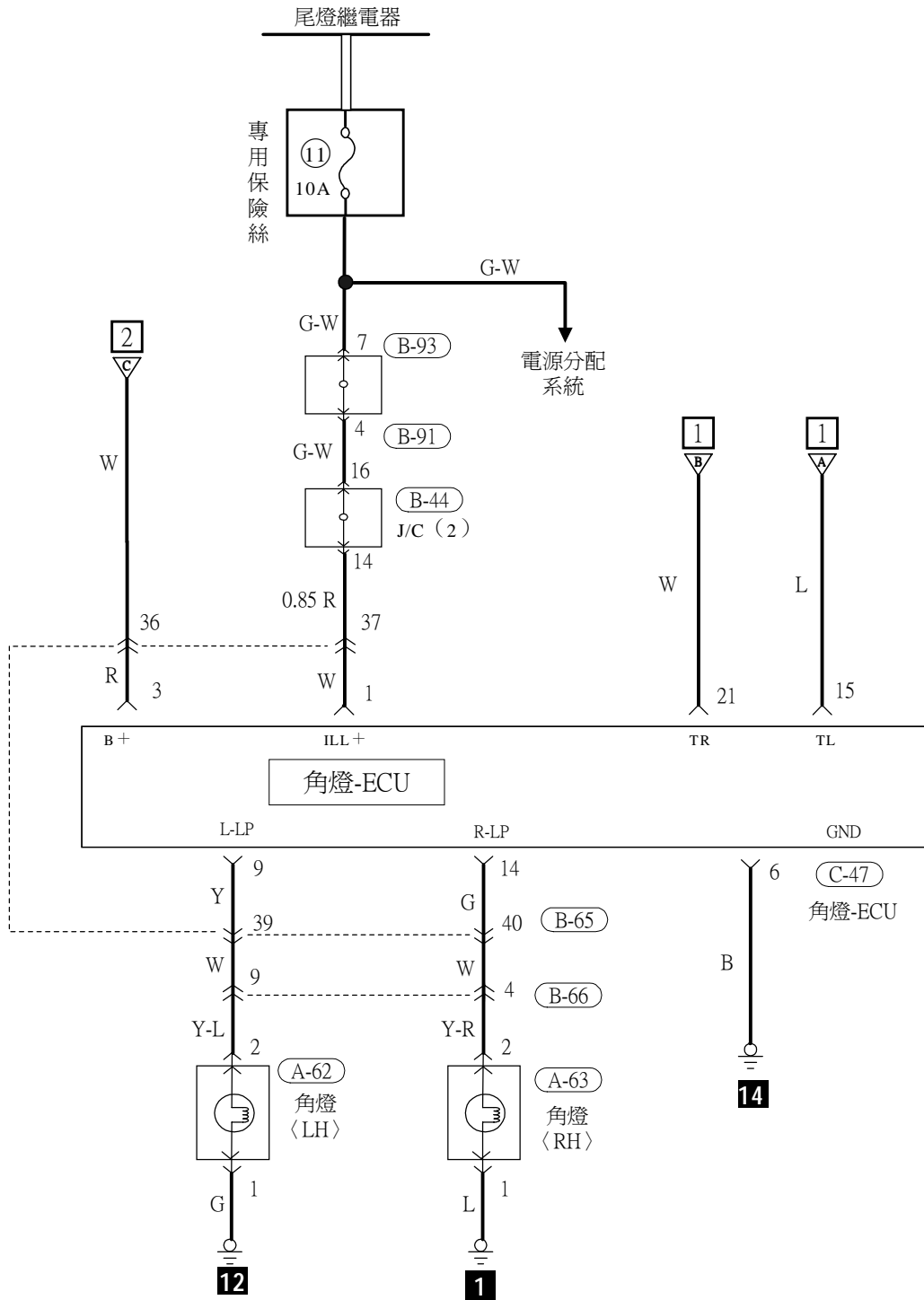

(A-62) (A-63)



(B-44)



(B-65)

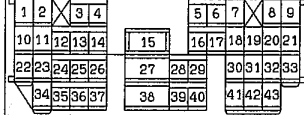

(B-66)

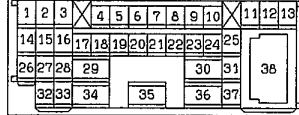

(B-91)

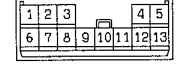

(B-93)

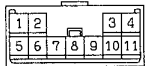

(C-47)

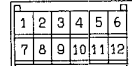

1

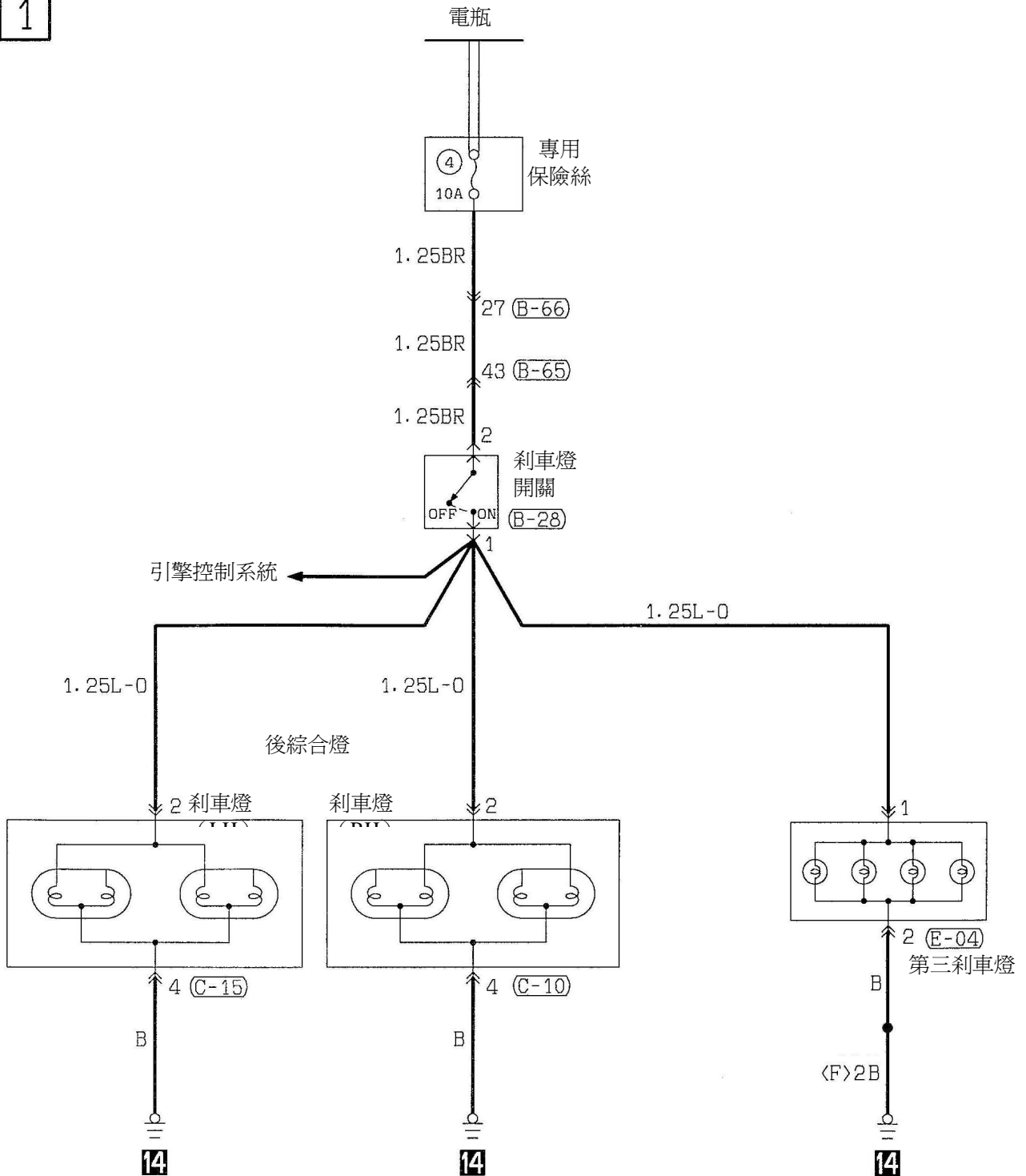

(B-28)



(B-65)

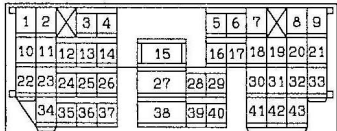

(B-66)

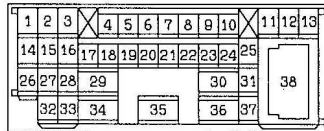

(C-10)



(C-15)



(E-04)



倒車燈

1

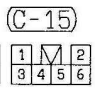
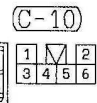
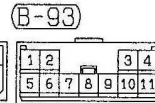
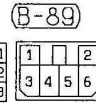
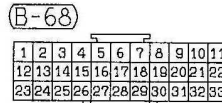
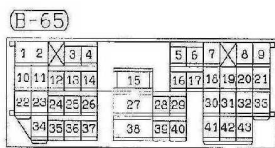
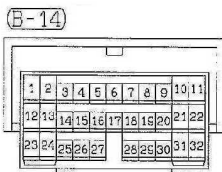
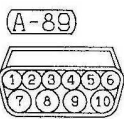
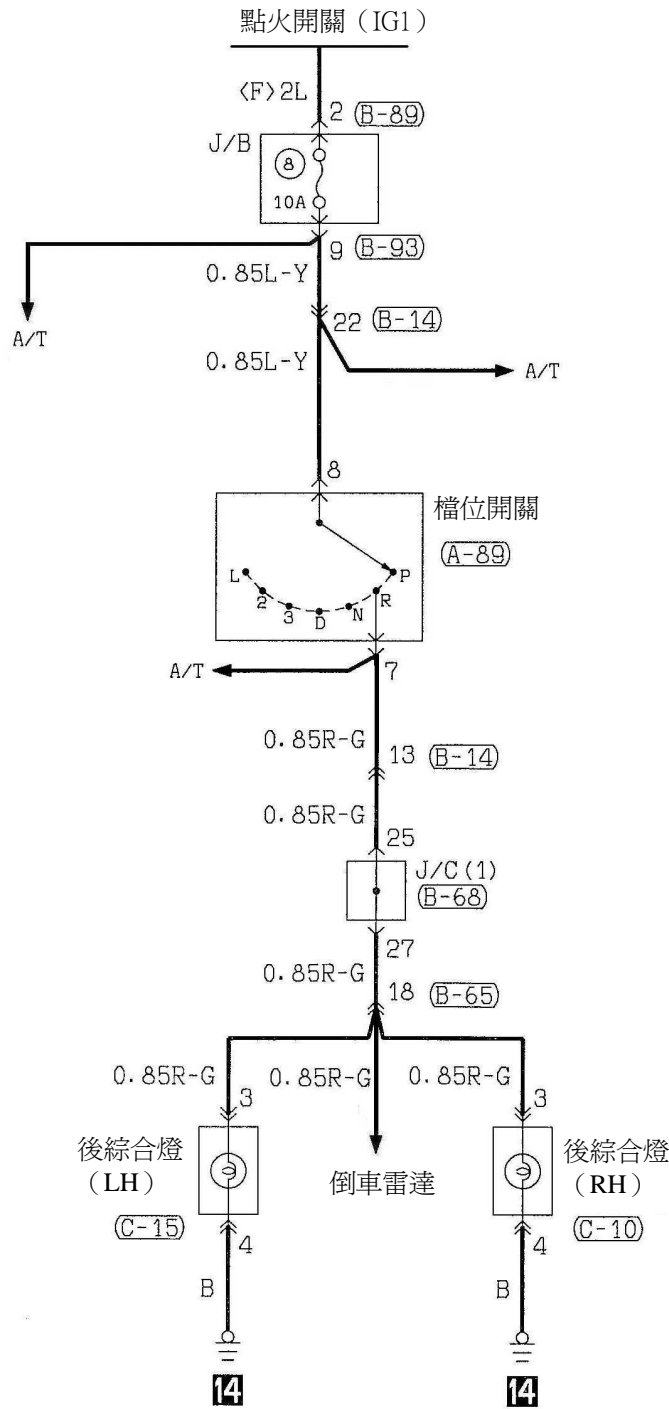

喇叭

1

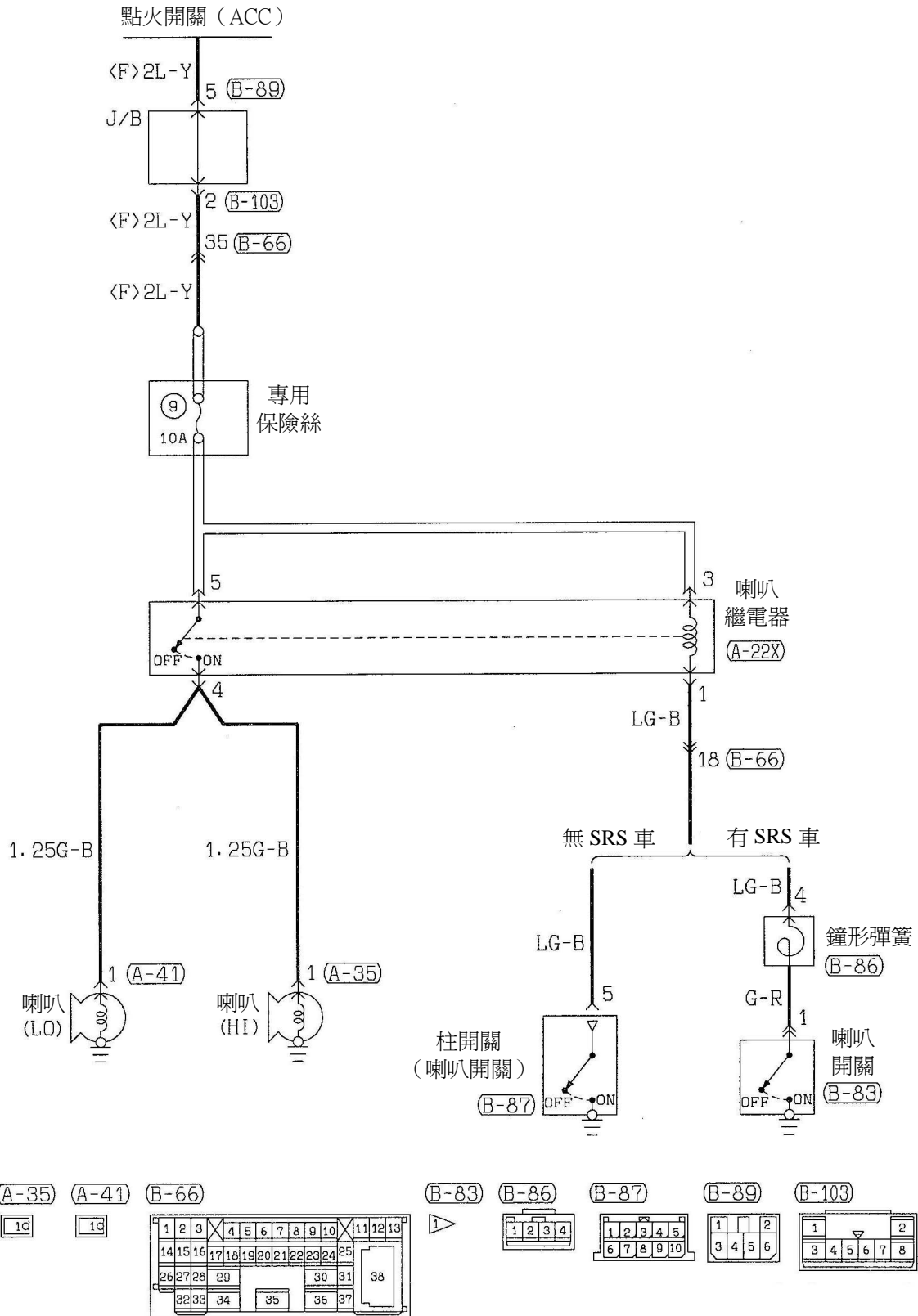

儀錶

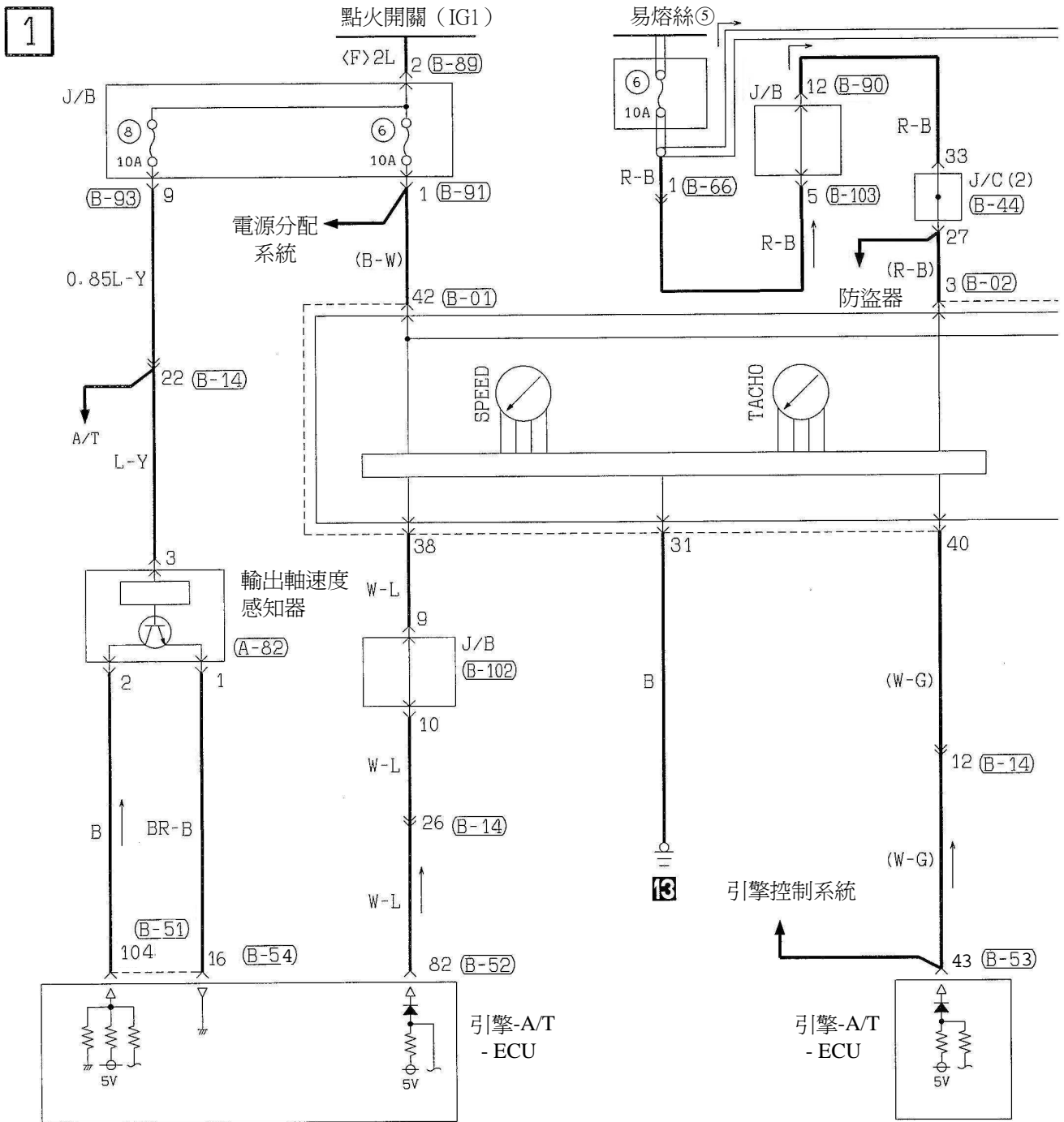

(A-24X) 1 2 3 4 5 6 7 8 9 10 11	(A-25X) 21 22 23 24 25 26 27 28 29 30 31	(A-82) ① ② ③	(A-83) ①	(B-01) 31 32 33 34 35 36 37 38 39	(B-02) 1 2 3 4 5 6 7 8 9 10 11 12 13	(B-51) 101 102 103 104 105 106 107 108 109 110 111 112 113 114 115 116 117 118 119 120 121 122 123 124 125 126 127 128 129 130
(B-52) 71 72 73 74 75 76 77 78 79 80 81 82 83 84 85 86 87 88 89 90 91 92 93 94 95 96 97 98	(B-53) 41 42 43 44 45 46 47 48 49 50 51 52 53 54 55 56 57 58 59 60 61 62 63 64 65 66	(B-89) 1 2 3 4 5 6	(B-90) 1 2 3 4 5 6 7 8 9 10 11 12 13	(B-91) 1 2 3 4 5 6 7 8 9 10 11 12 13	(B-93) MU801847 1 2 3 4 5 6 7 8 9 10 11	(B-102) 1 2 3 4 5 6 7 8 9 10
(B-103) 1 2 3 4 5 6 7 8						

2

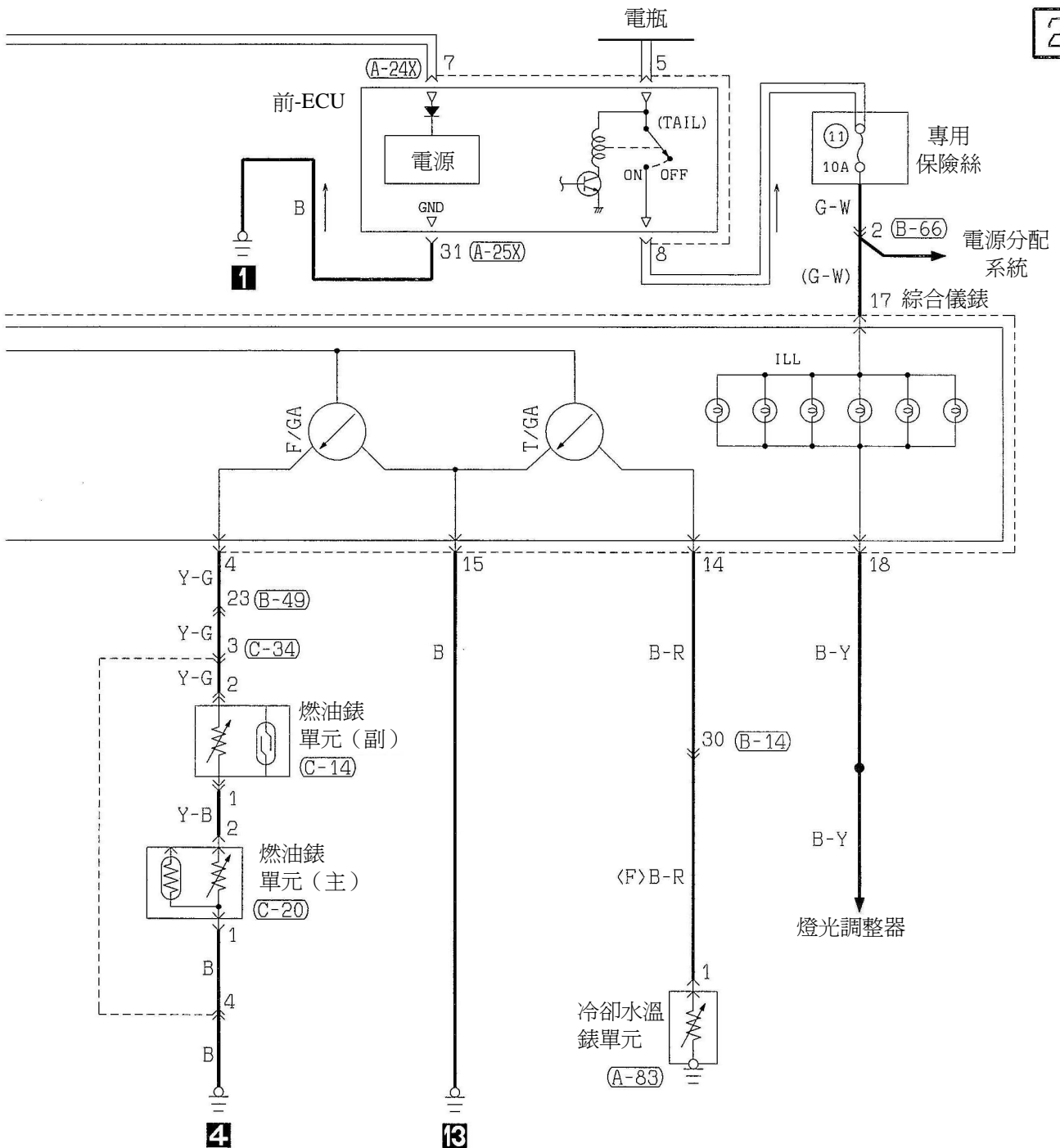

(B-14)

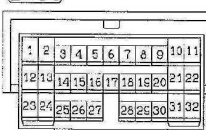

(B-44)

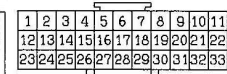

(B-49)

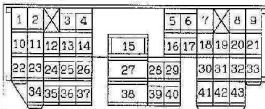

(B-66)

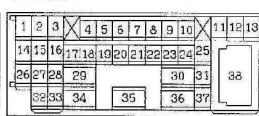

(C-14)



(C-20)



(C-34)

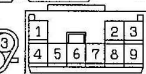

警告燈

剎車警告燈/燃油不足警告燈

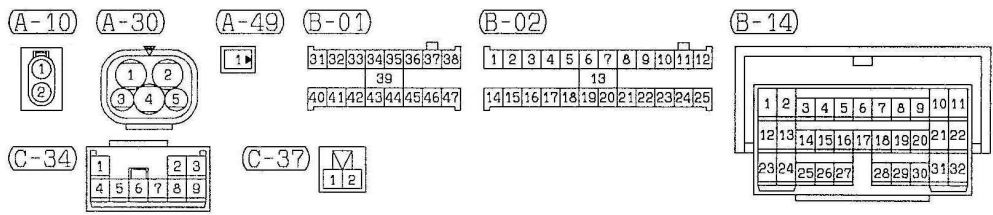
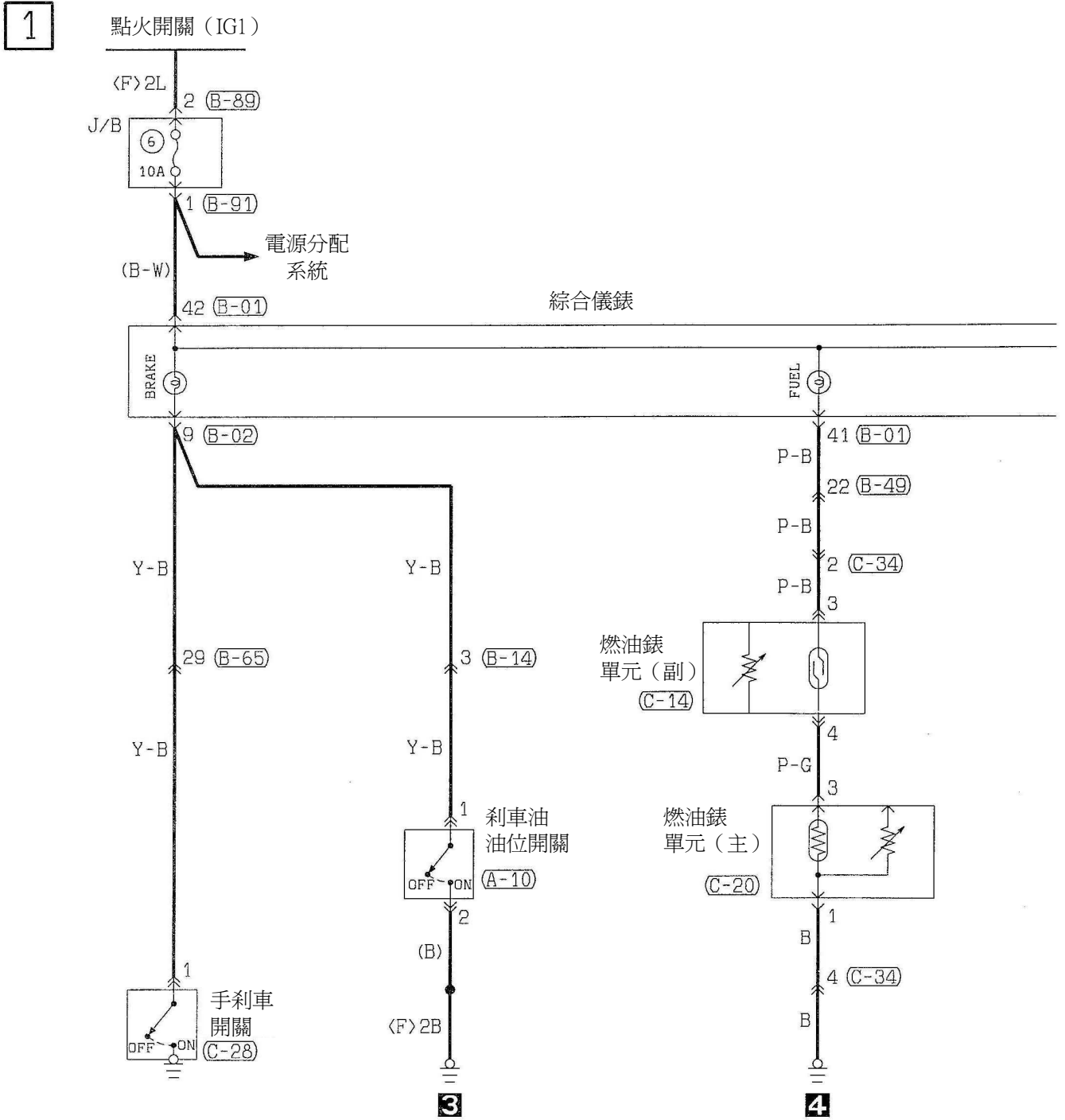

警告燈

機油壓力警告燈/安全帶未繫警告燈

2

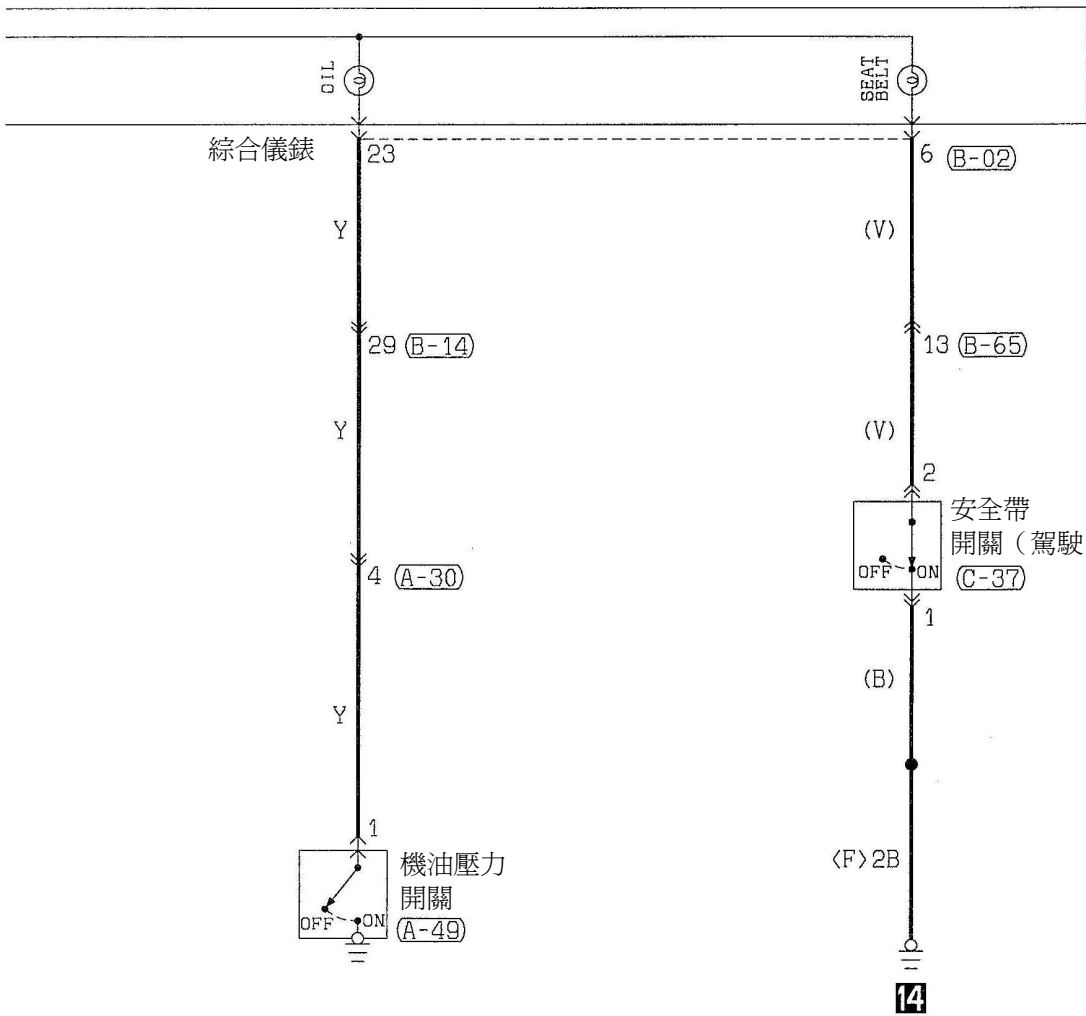

(B-49)

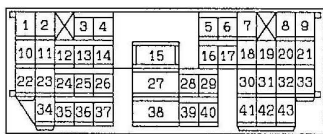

(B-65)

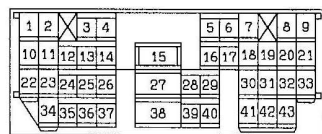

(B-89)



(B-91)

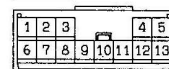

(C-14)



(C-20)



(C-28)



電動窗

1

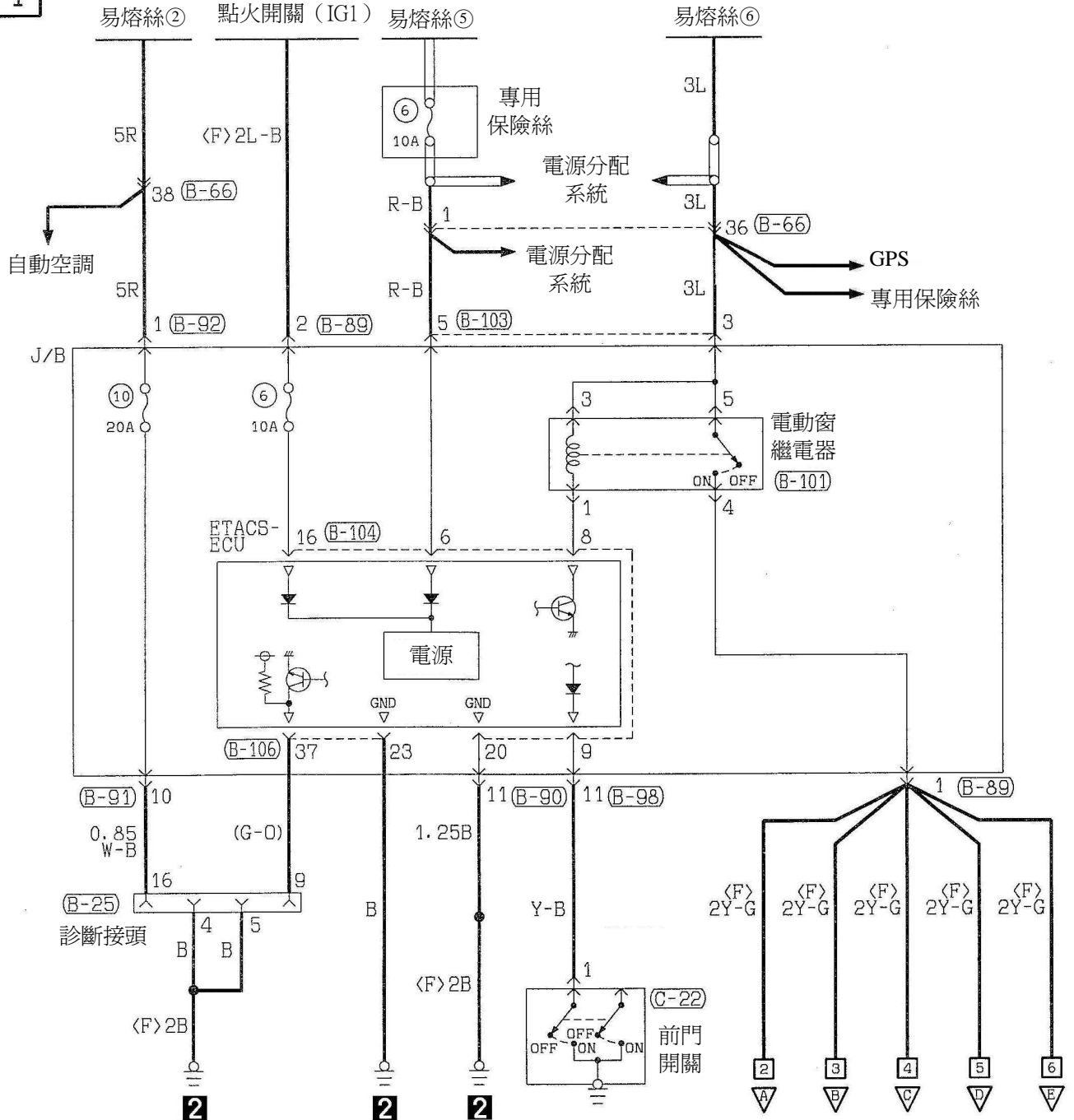

(B-25)

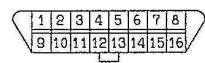

(D-04)



(D-05)



(B-47)

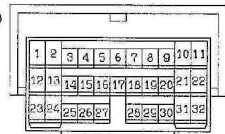

(B-66)

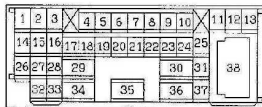

(B-89)



(B-90)

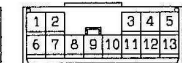

(B-91)

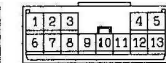

(B-92)



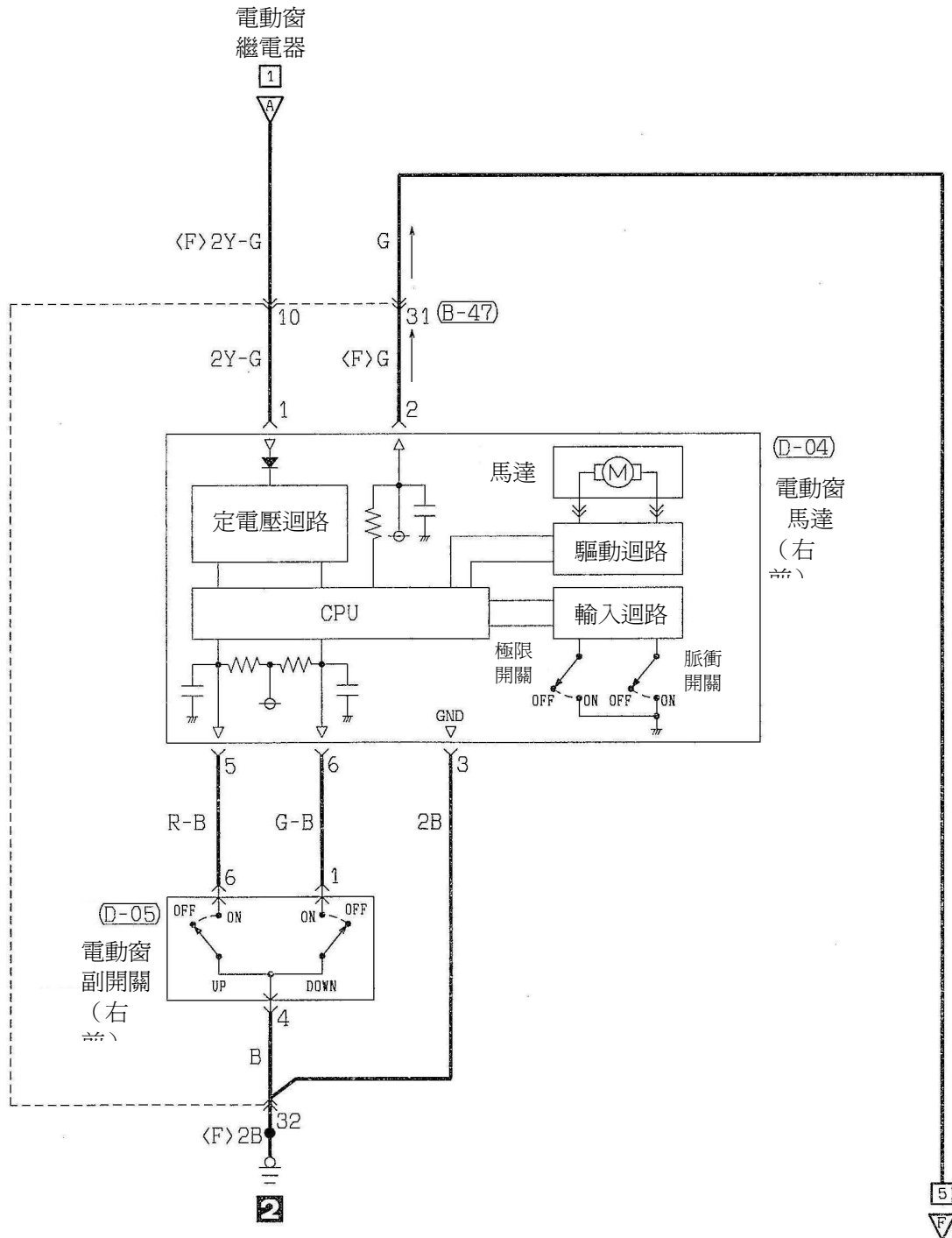

(B-98)

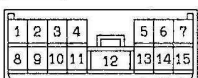

(B-101)



(B-103)

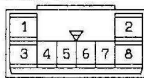

(B-104)

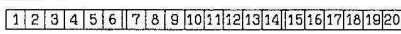

(B-106)

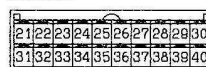

(C-22)



電動窗

3

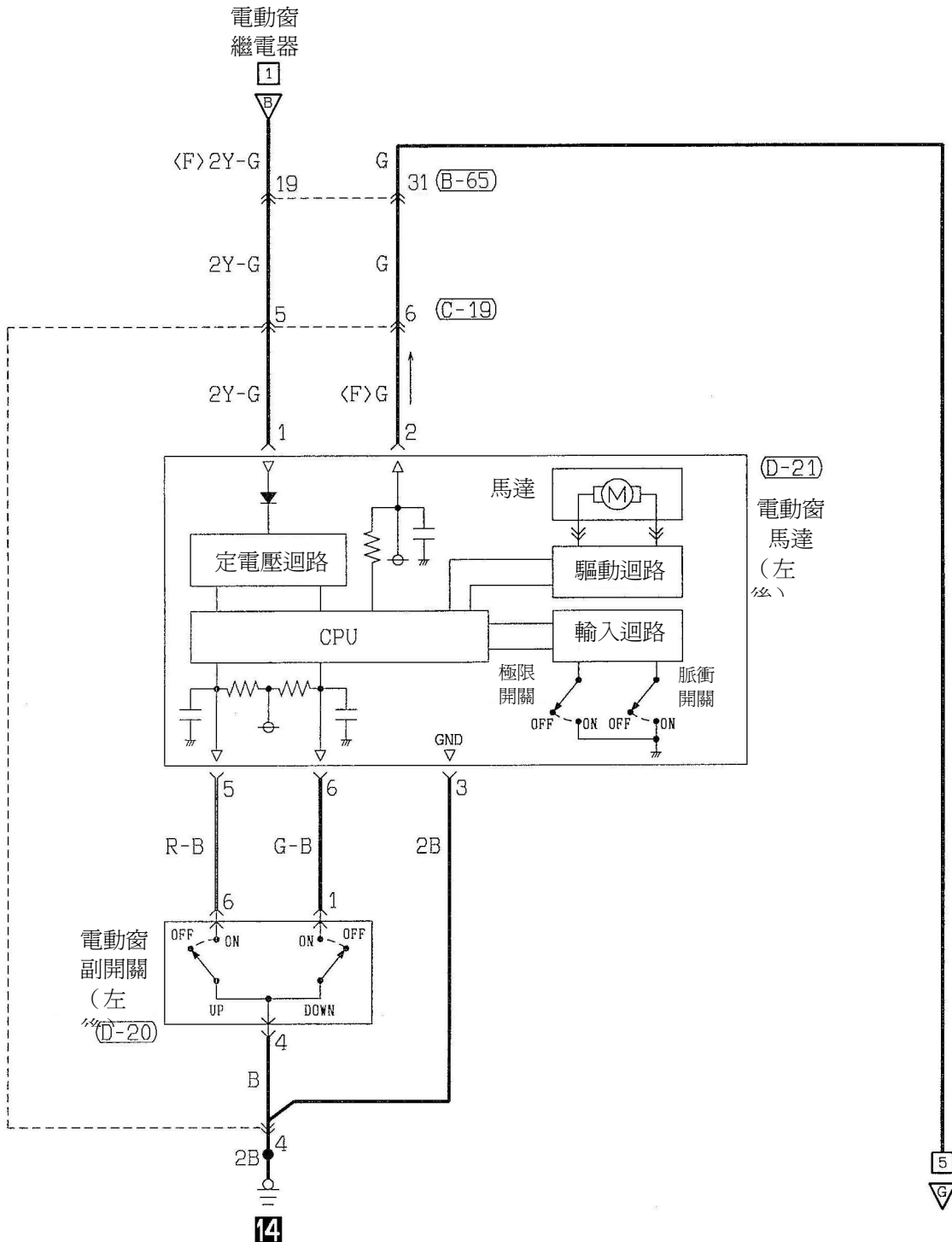

14

(B-49)

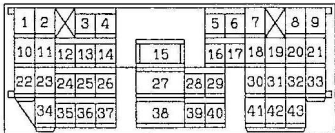

(B-65)

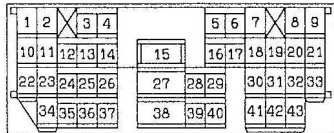

(C-03)

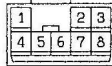

(C-19)



(D-09)



(D-10)



(D-20)



電動窗

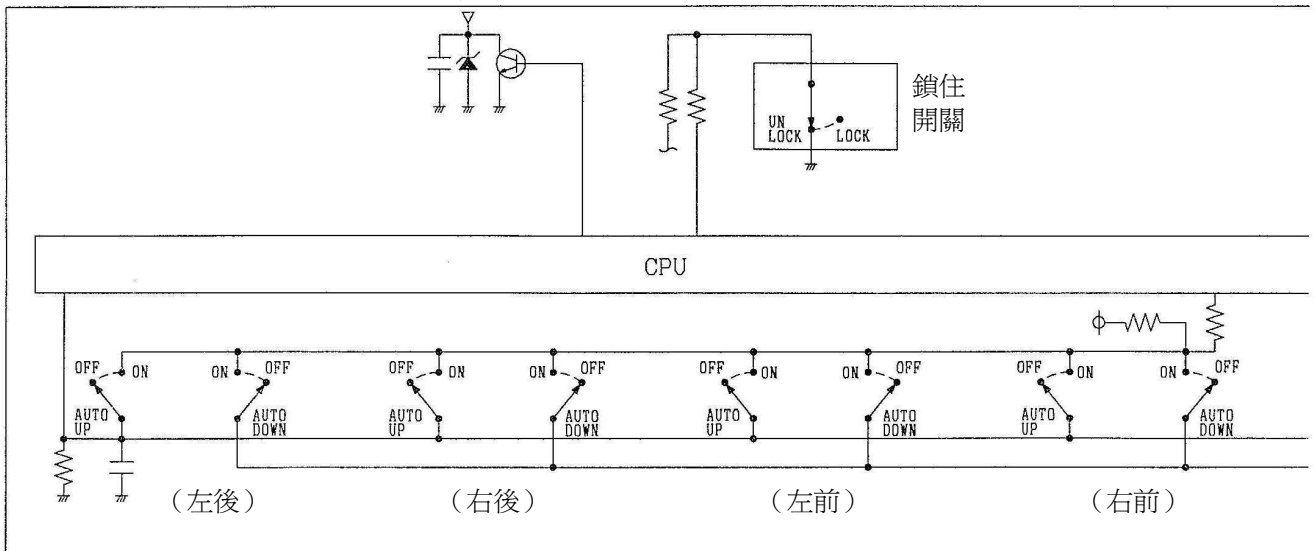
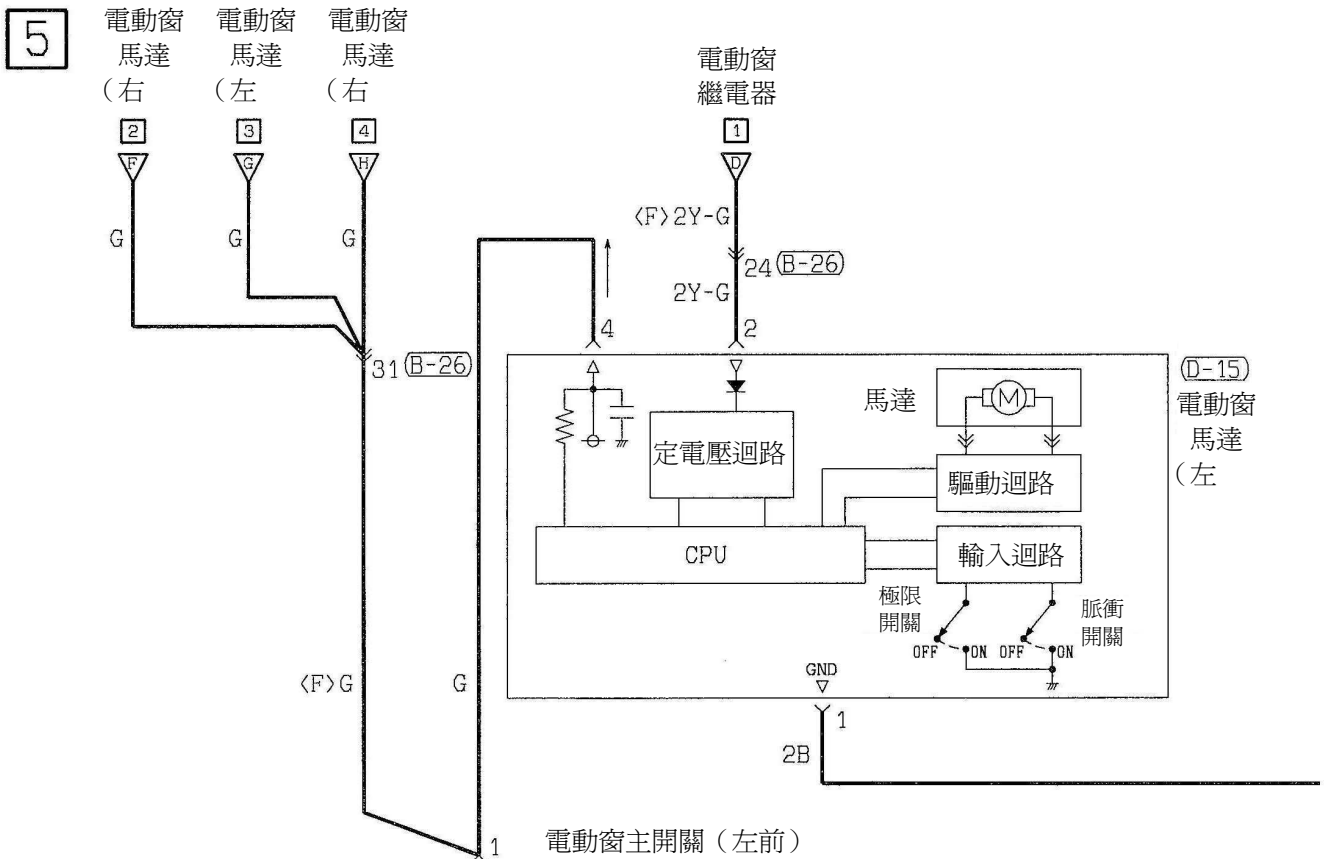

(B-68)

1	2	3	4	5	6	7	8	9	10	11
12	13	14	15	16	17	18	19	20	21	22
23	24	25	26	27	28	29	30	31	32	33

(B-26)

1	2	3	4	5	6	7	8	9	10	11
12	13	14	15	16	17	18	19	20	21	22
23	24	25	26	27	28	29	30	31	32	

(B-106)

21	22	23	24	25	26	27	28	29	30
31	32	33	34	35	36	37	38	39	40

(D-15)

1	2	3	4
---	---	---	---

(D-17)

1	2	3	4	5	6	7
8	9	10	11	12	13	14

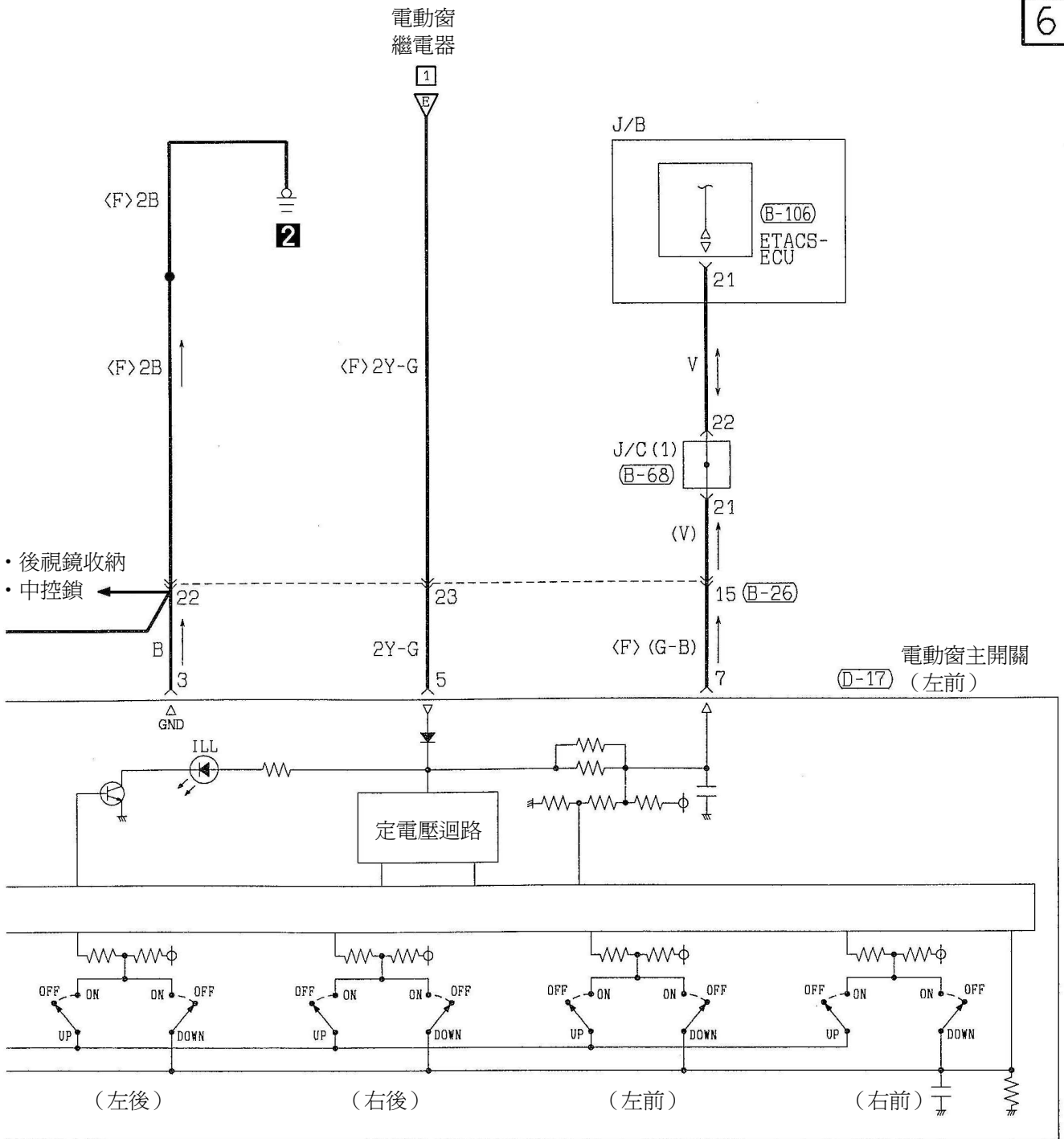

54D-84 DZL 迴路圖－中控鎖及防盜系統

中控鎖及防盜系統

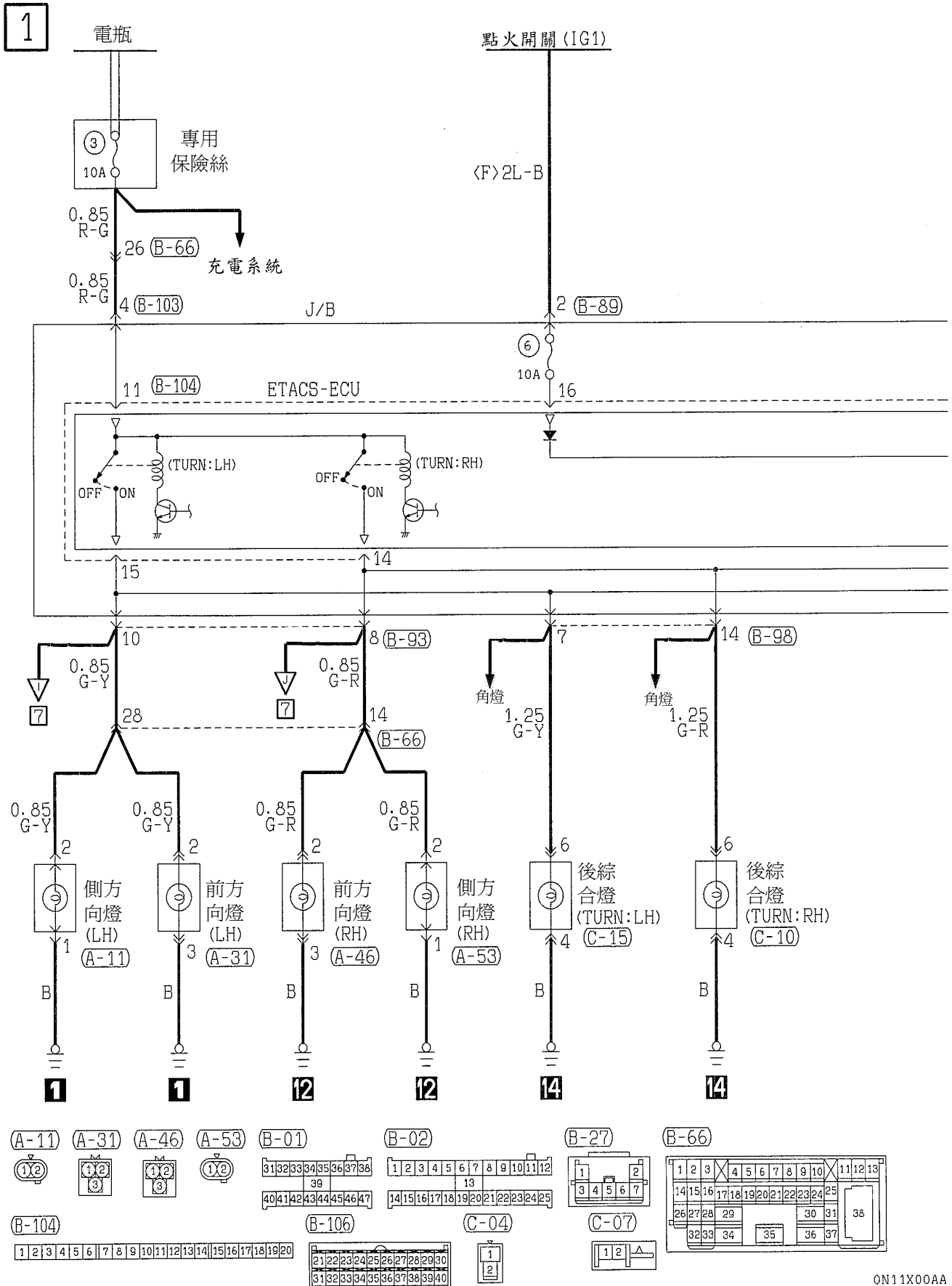

中控鎖及防盜系統

2

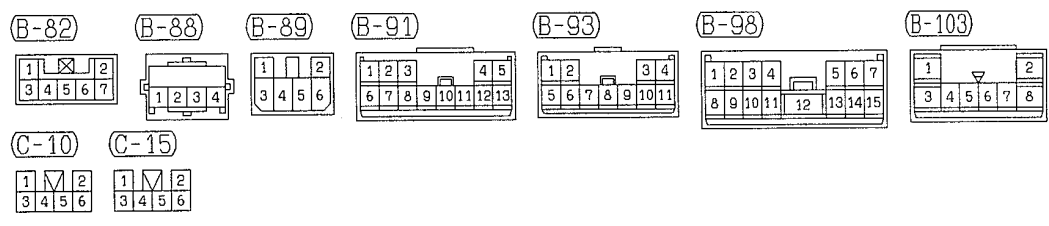
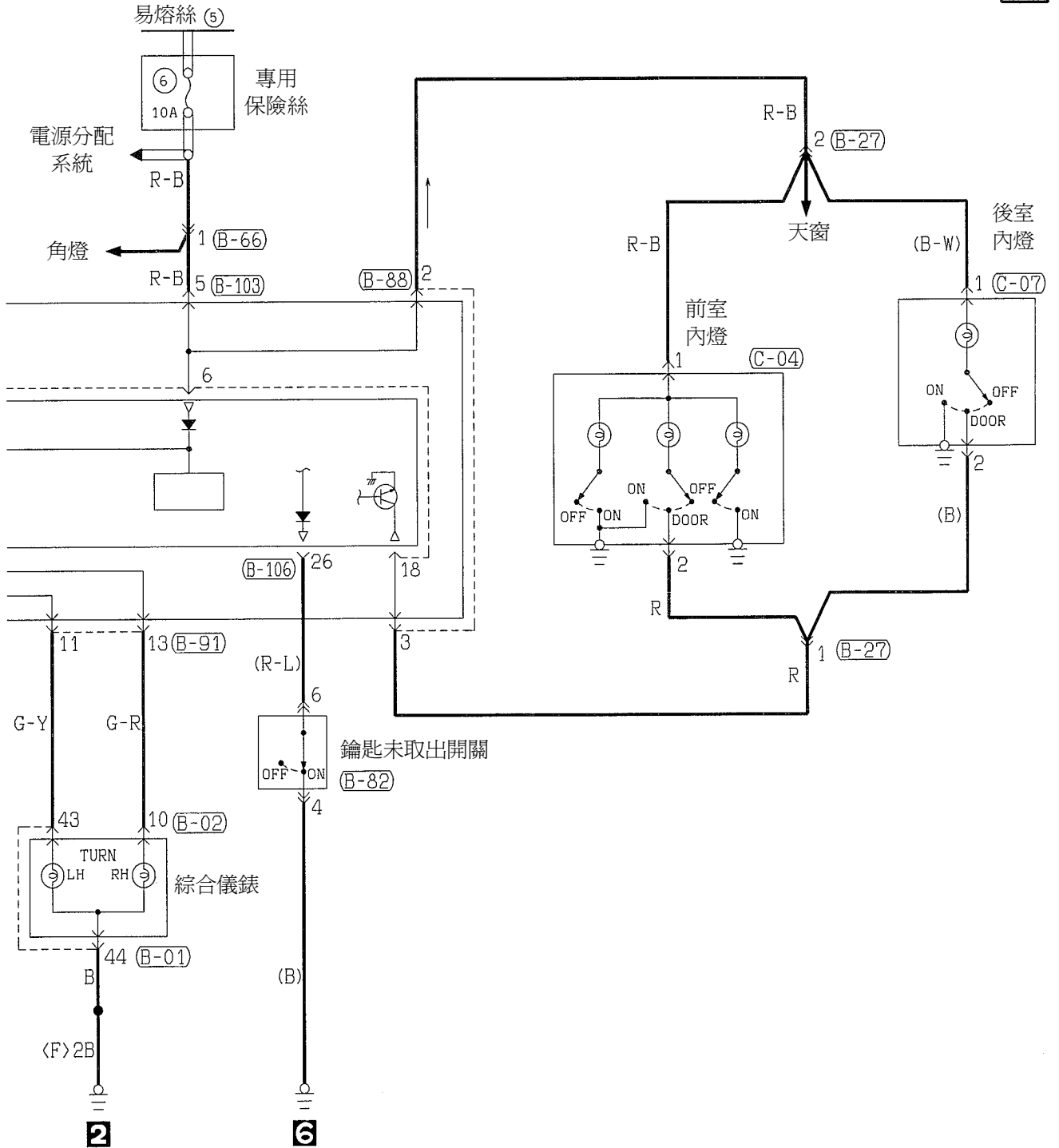

54D-86 DZL 迴路圖－中控鎖及防盜系統

中控鎖及防盜系統(續)

3

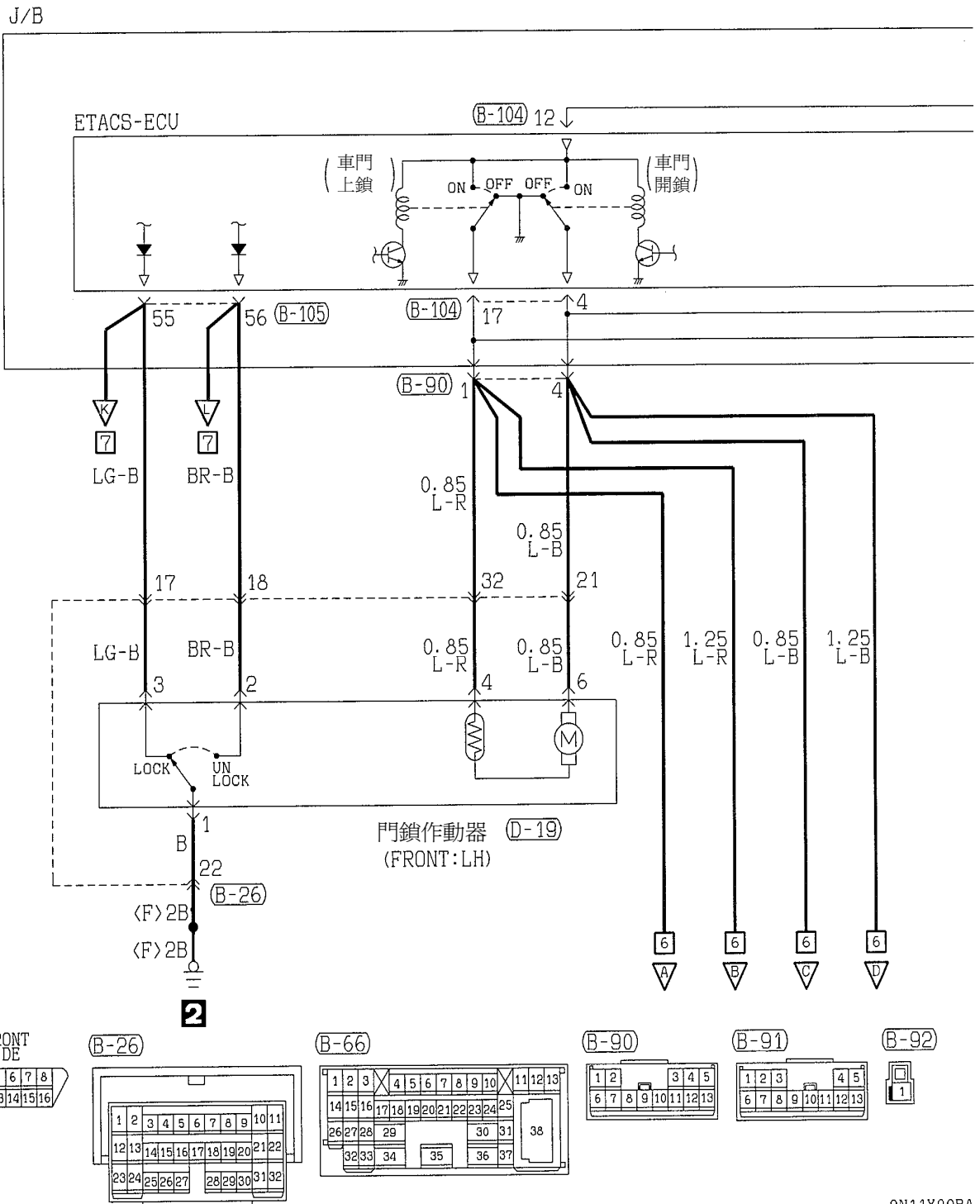

ON11X00BA

中控鎖及防盜系統(續)

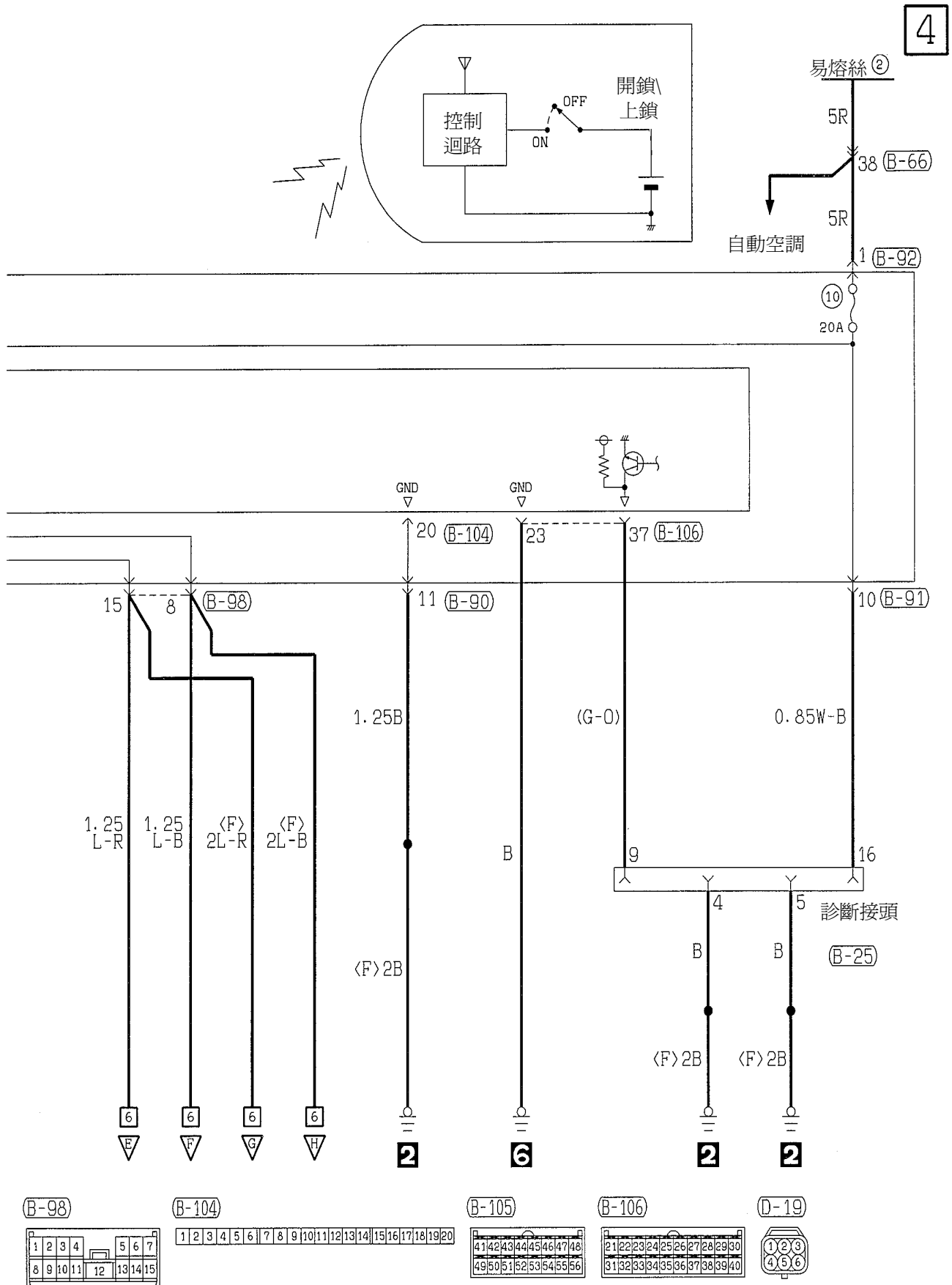

54D-88 DZL 迴路圖－中控鎖及防盜系統

中控鎖及防盜系統(續)

5

J/B

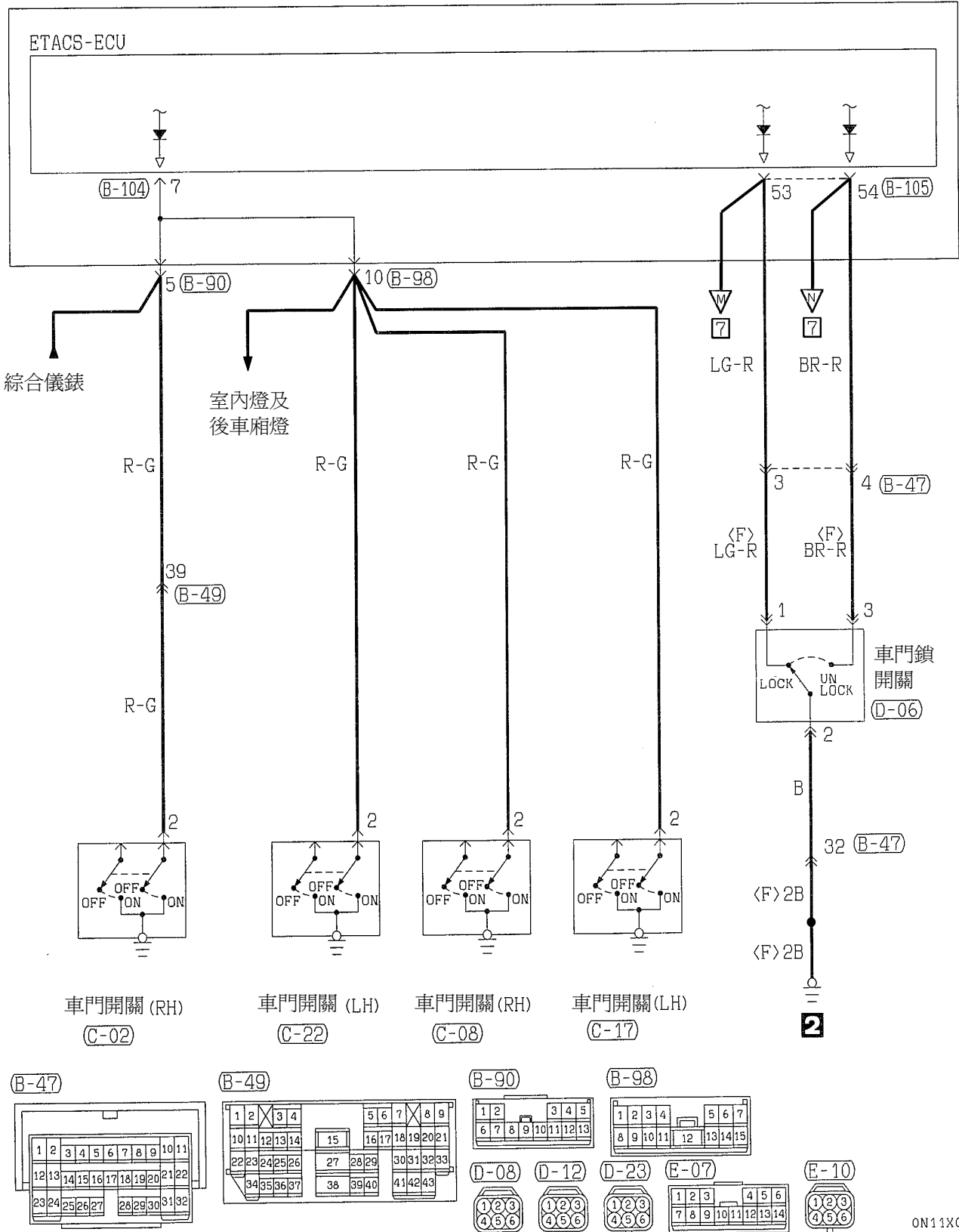

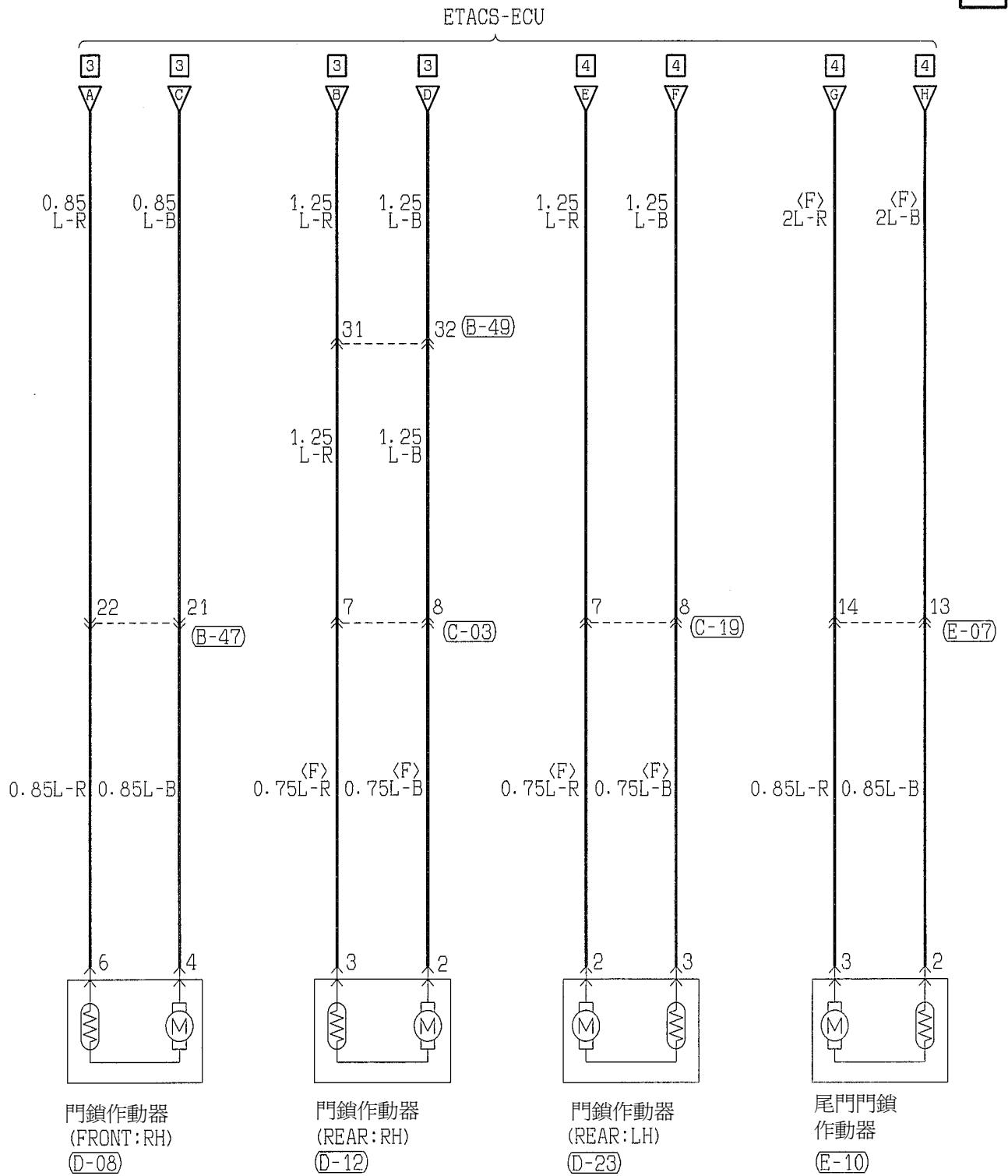

(B-104)

1 2 3 4 5 6 7 8 9 10 11 12 13 14 15 16 17 18 19 20

(B-105)

41	42	43	44	45	46	47	48
49	50	51	52	53	54	55	56

(C-02)

1	2	3
---	---	---

(C-03)

1	2	3		
4	5	6	7	8

(C-08)

1	2	3
---	---	---

(C-17)

1	2	3
---	---	---

(C-19)

1	2	3		
4	5	6	7	8

(C-22)

1	2	3
---	---	---

(D-06)

1	2	3
---	---	---

54D-90 DZL 迴路圖－中控鎖及防盜系統

中控鎖及防盜系統(續)

7

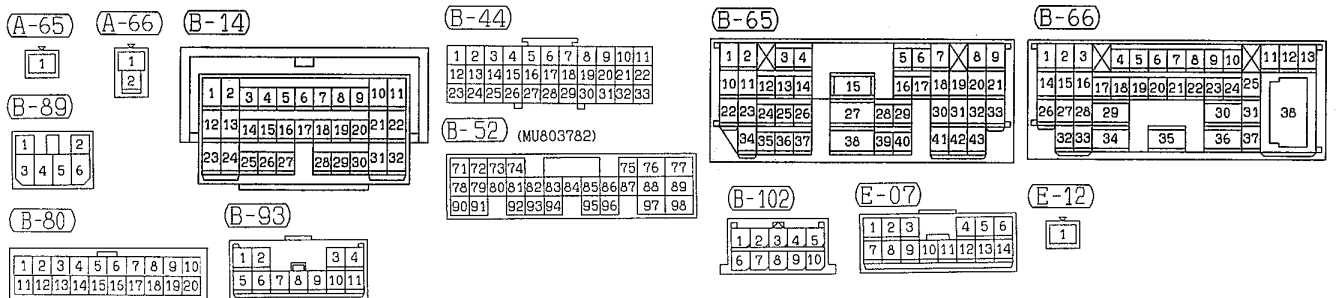
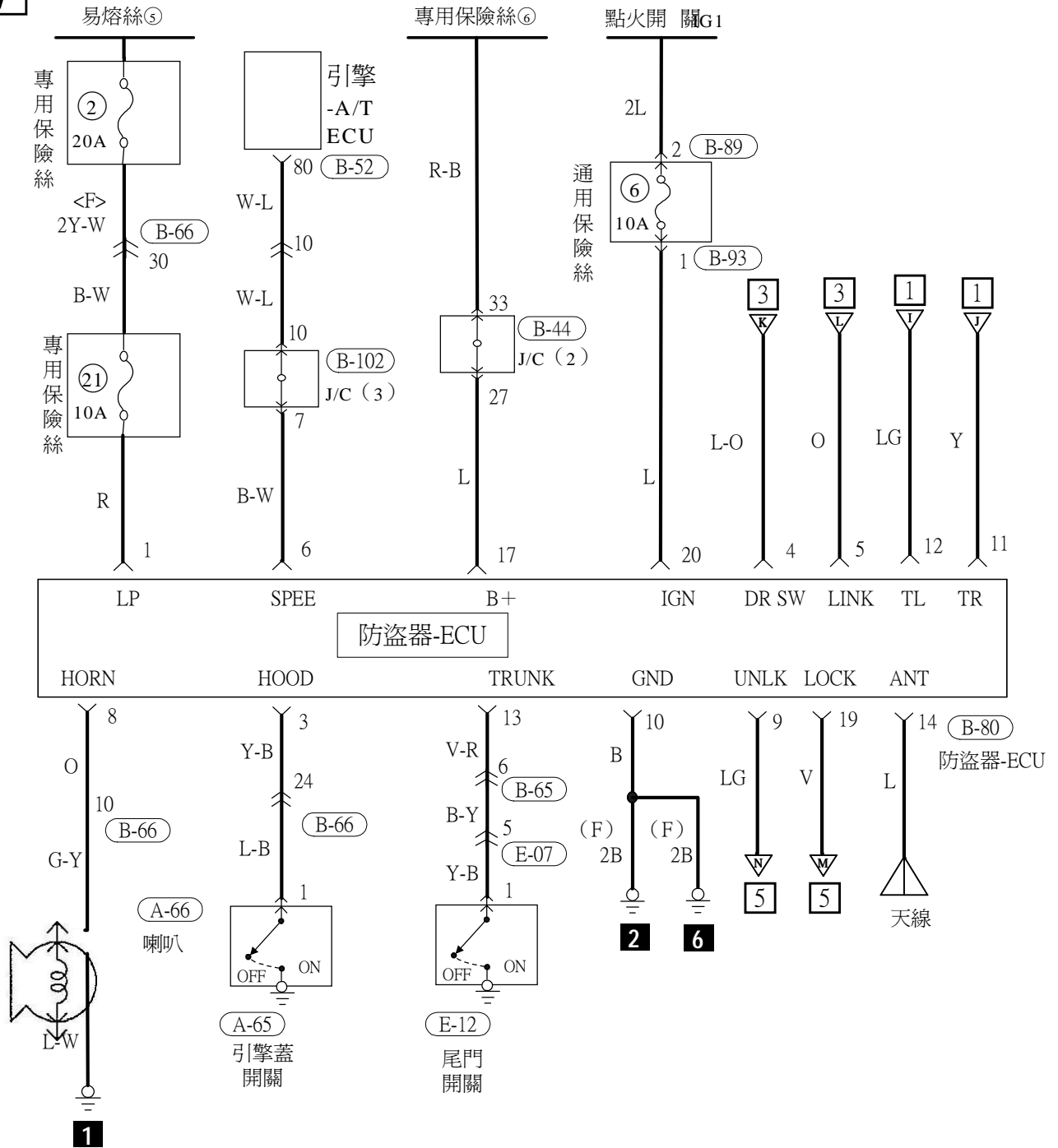

手動空調除霧系統

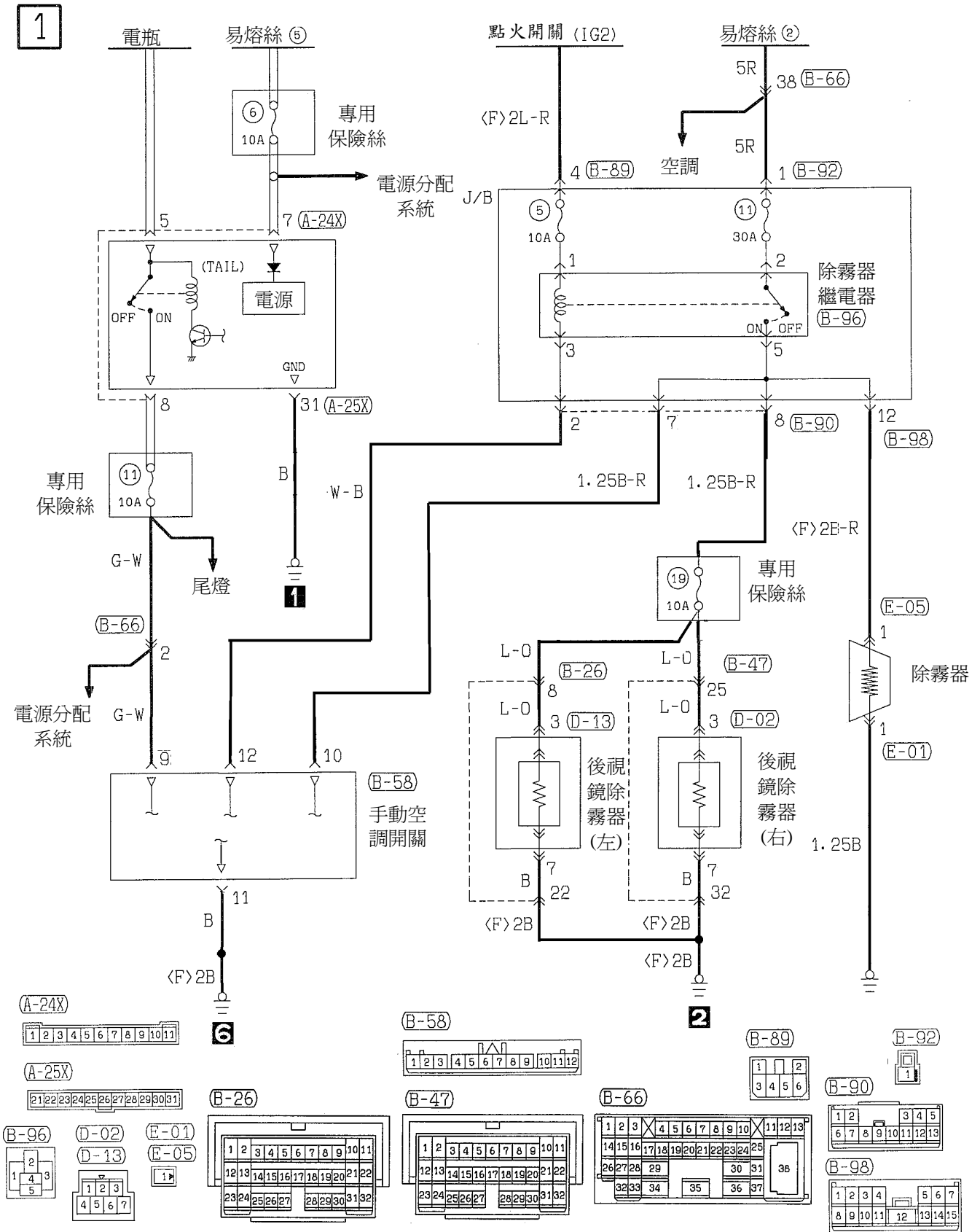

手動空調系統

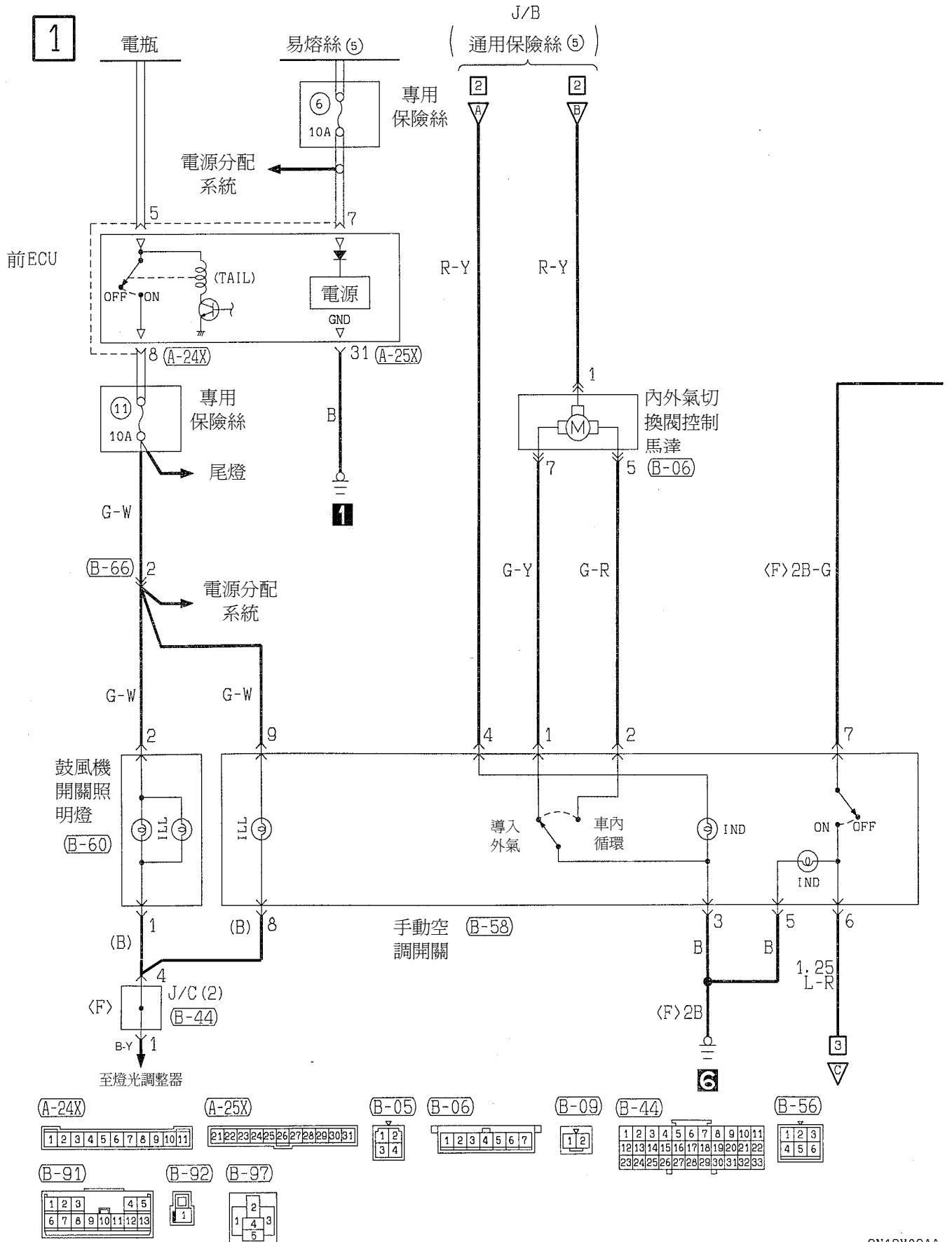

手動空調系統

2

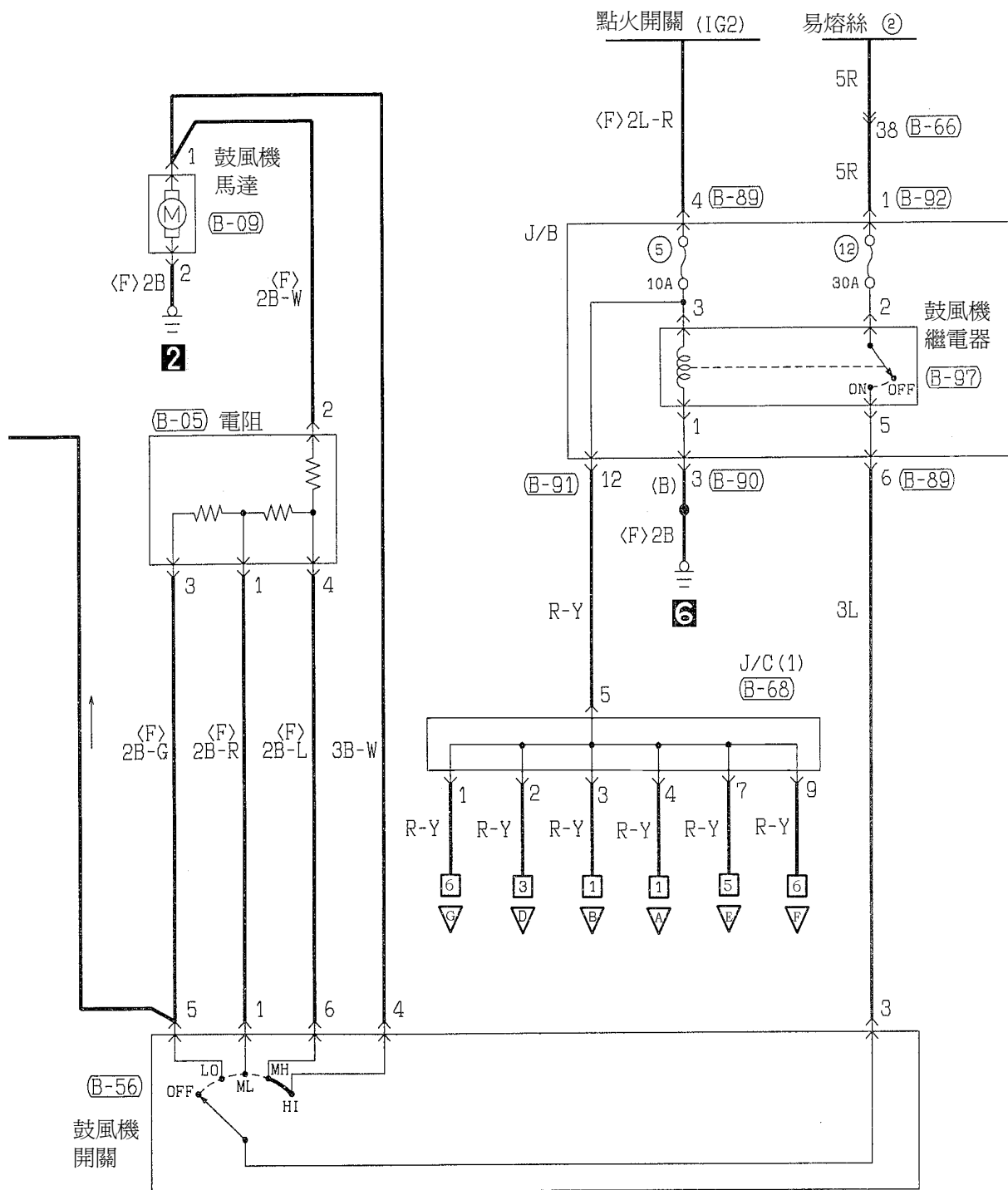

(B-58)

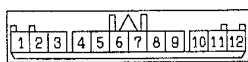

(B-60)



(B-66)

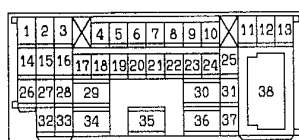

(B-68)



(B-89)



(B-90)

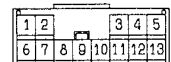

手動空調系統(續)

5

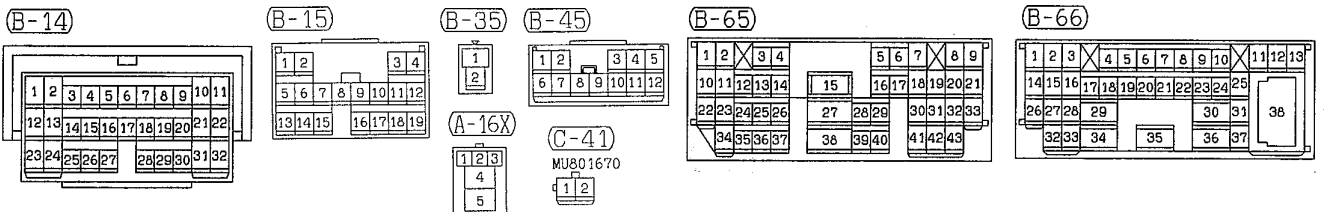
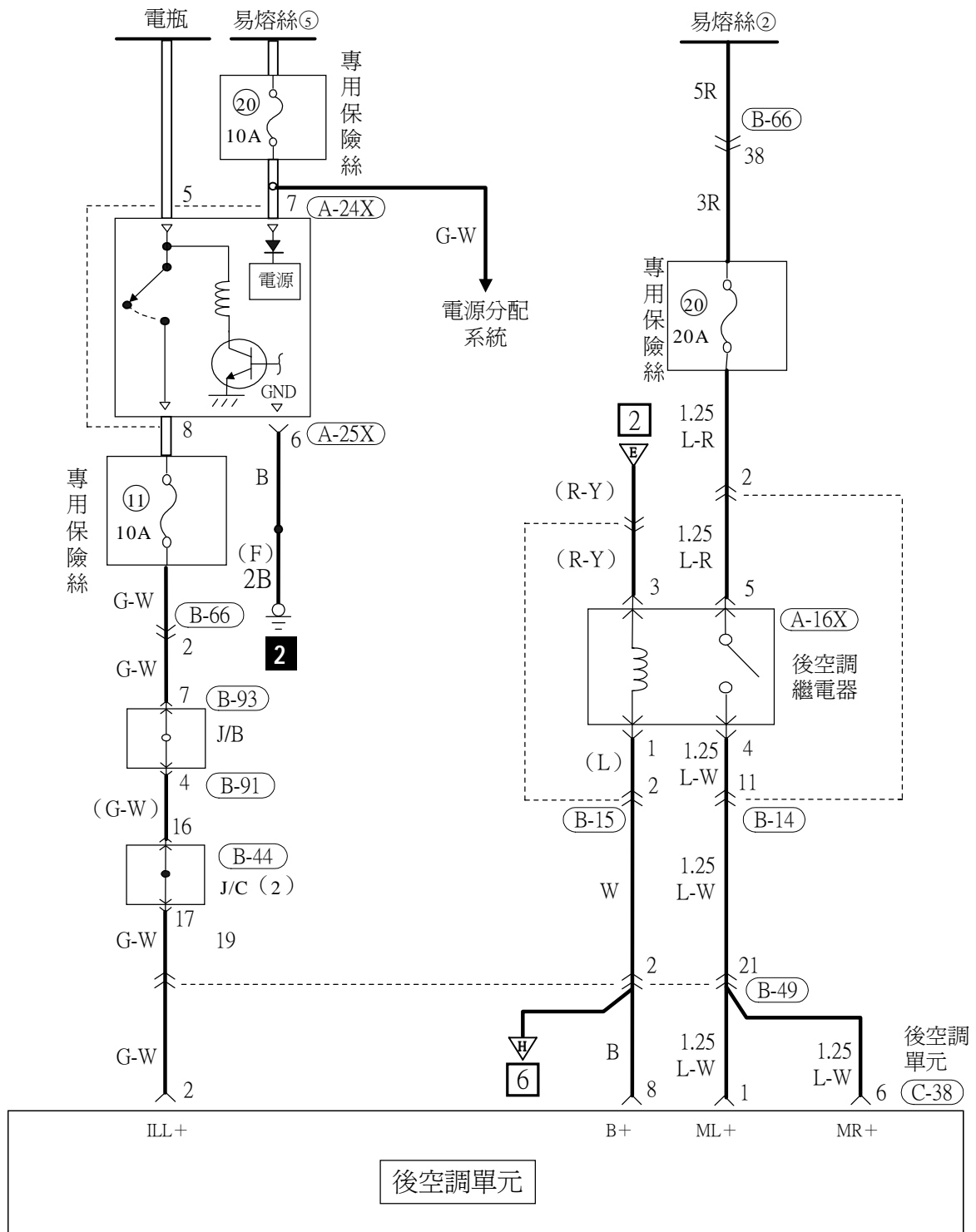

6

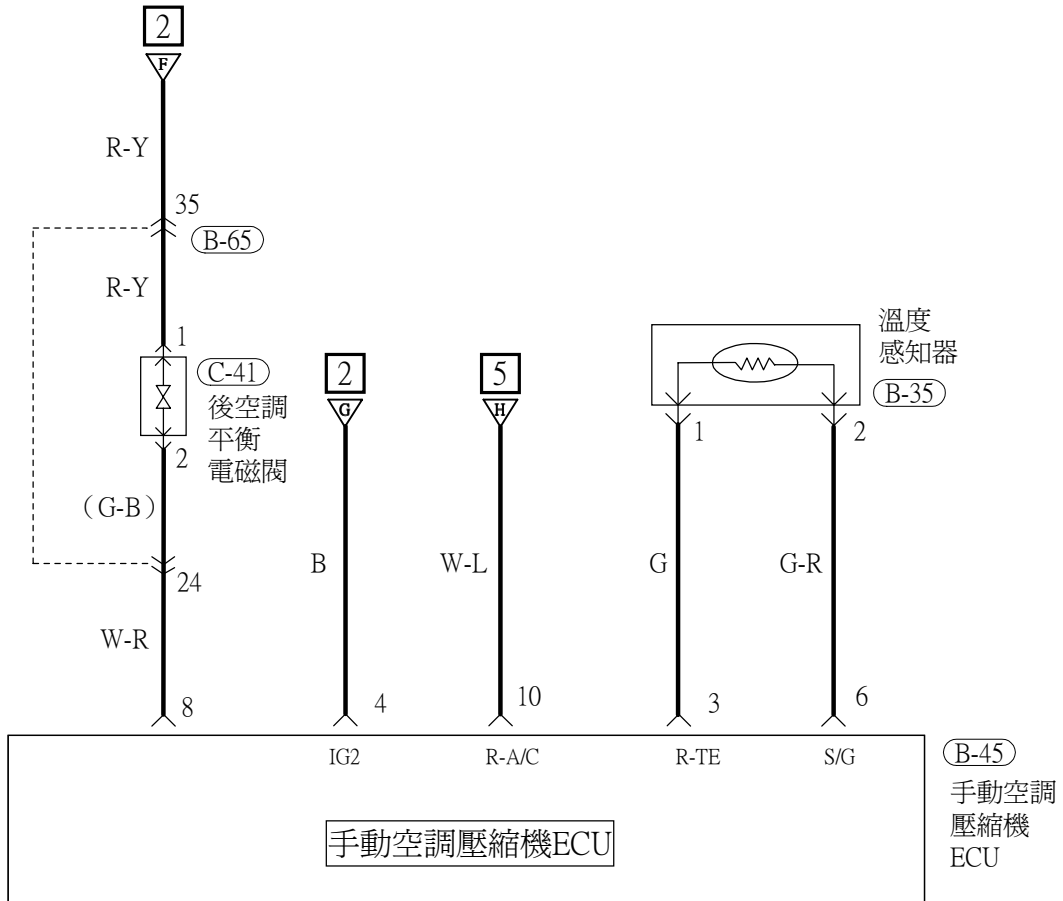

(B-15)

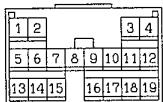

(B-44)



(B-49)

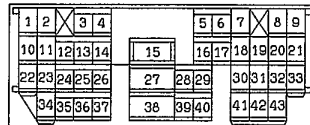

(B-66)

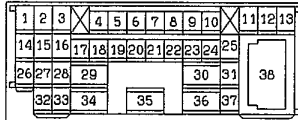

(B-91)

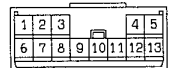

(C-38)

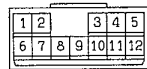

自動空調系統

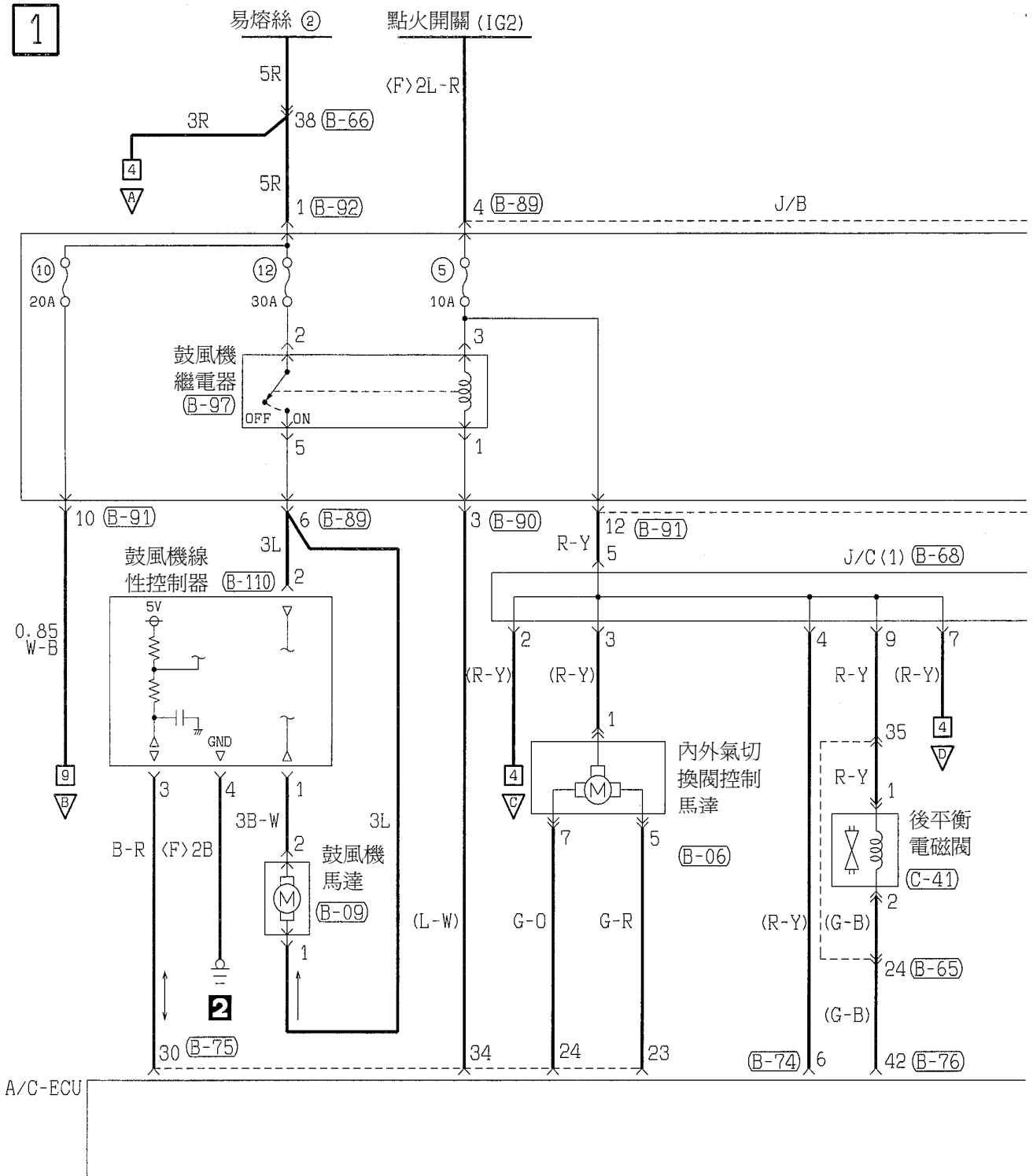

(A-24X)

1	2	3	4	5	6	7	8	9	10	11
---	---	---	---	---	---	---	---	---	----	----

(A-25X)

21	22	23	24	25	26	27	28	29	30	31
----	----	----	----	----	----	----	----	----	----	----

(B-06)

1	2	3	4	5	6	7
---	---	---	---	---	---	---

(B-09) (B-44)

1	2	3	4	5	6	7	8	9	10	11
12	13	14	15	16	17	18	19	20	21	22
23	24	25	26	27	28	29	30	31	32	33

(B-49)

1	2	3	4	5	6	7	8	9
10	11	12	13	14	15	16	17	18
19	20	21	22	23	24	25	26	27
28	29	30	31	32	33	34	35	36
37	38	39	40	41	42	43		

(B-76) (MU801583)

41	42	43	44	45	46
47	48	49	50	51	52

(B-89) MU801331

1	2
3	4
5	6

(B-90) MU801855

1	2	3	4	5
6	7	8	9	10
11	12	13		

(B-91) (MU801860)

1	2	3	4	5
6	7	8	9	10
11	12	13		

(B-92)

1

(B-93) MU801847

1	2	3	4
5	6	7	8
9	10	11	

(B-97)

1	2	3
4	5	

H1N12X00AA

自動空調系統

2

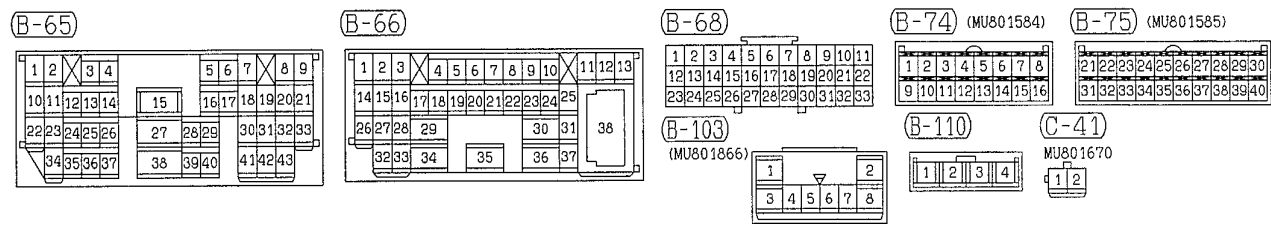
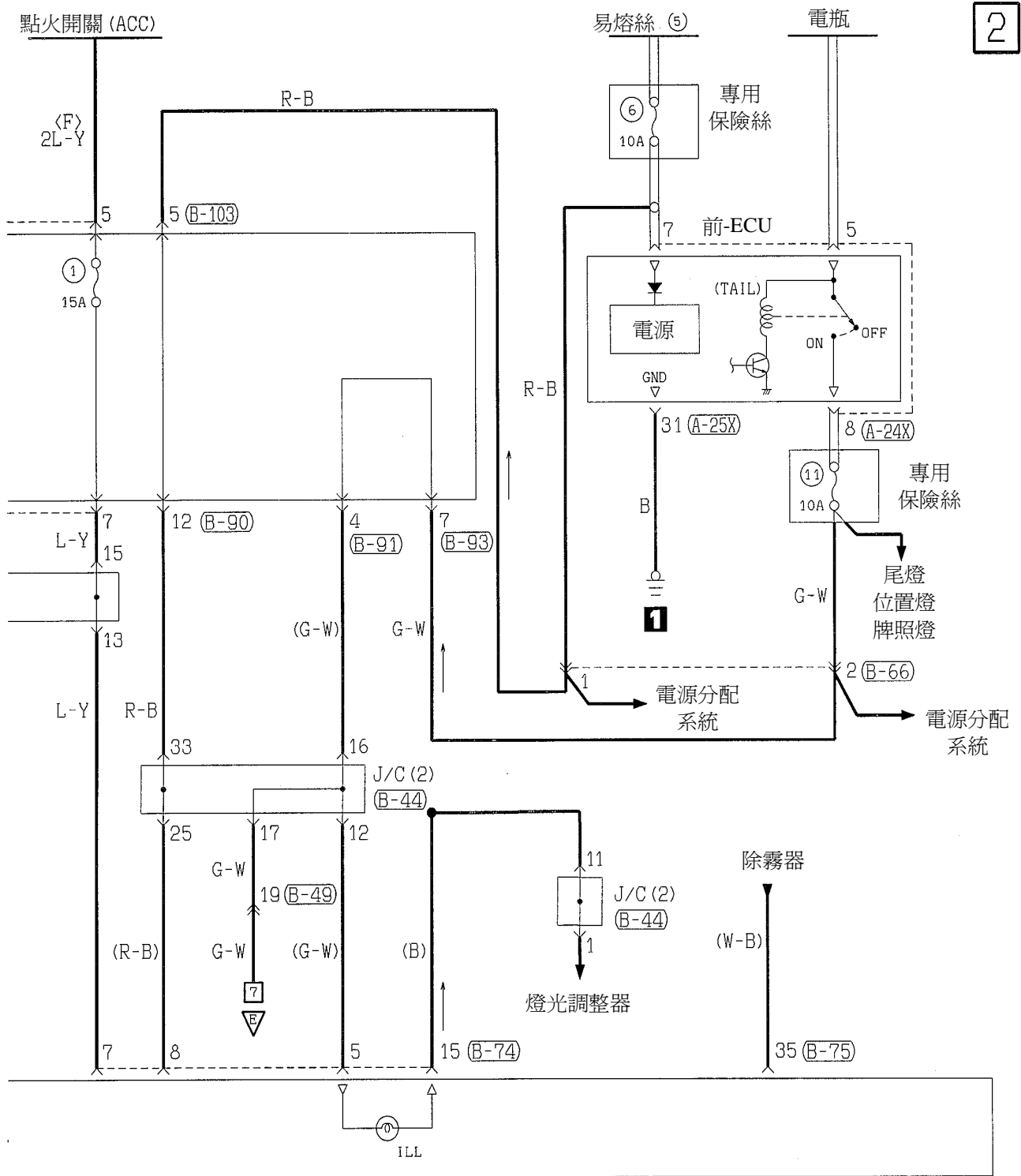

自動空調系統(續)

3

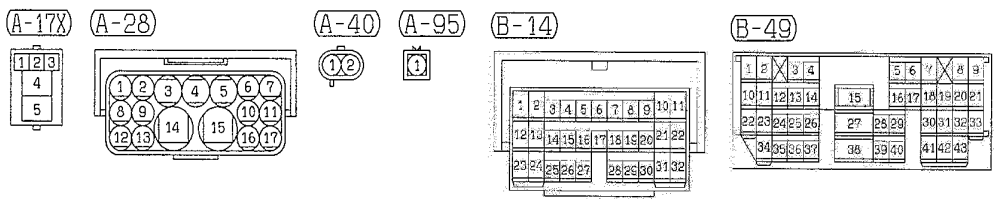
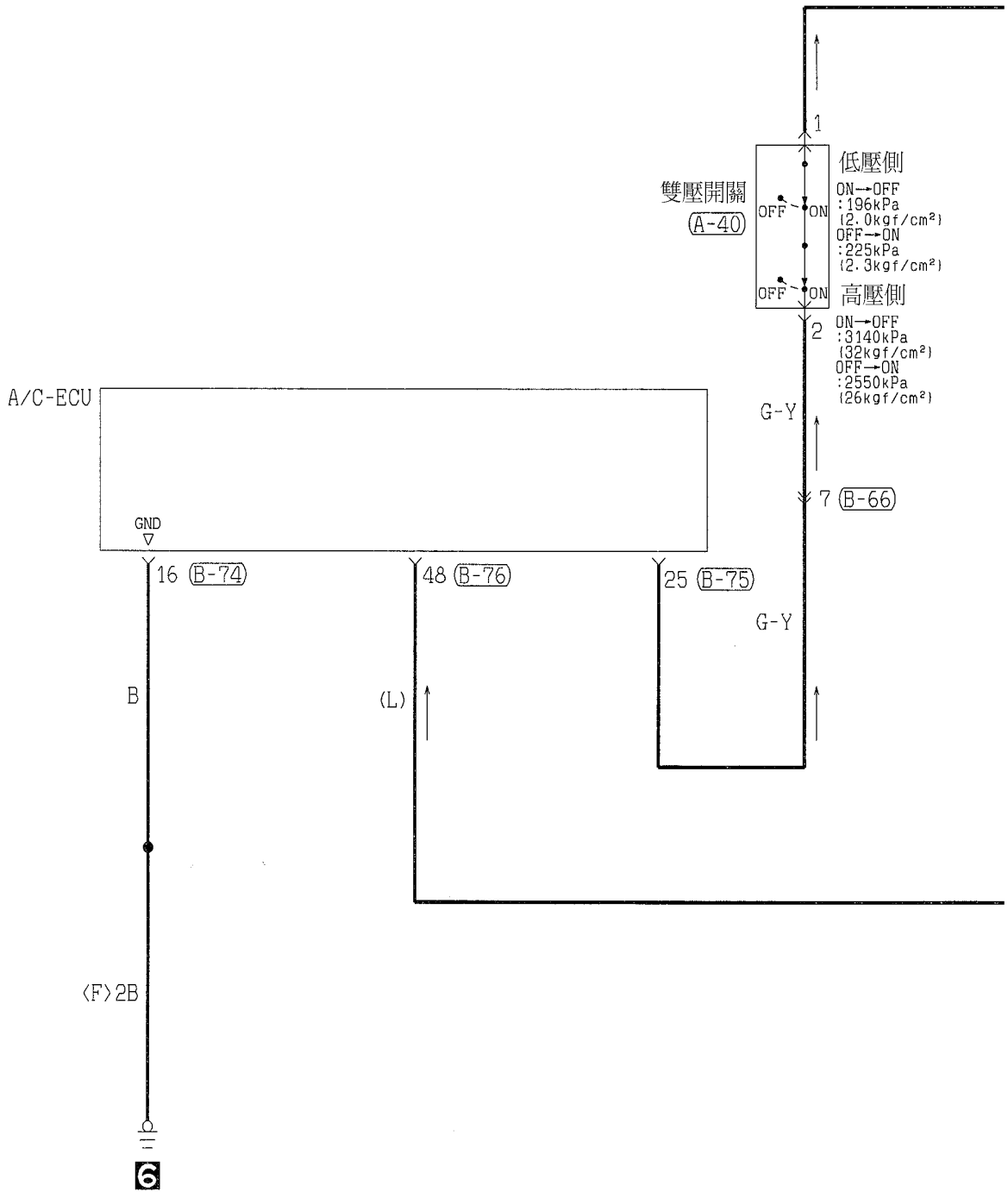

自動空調系統(續)

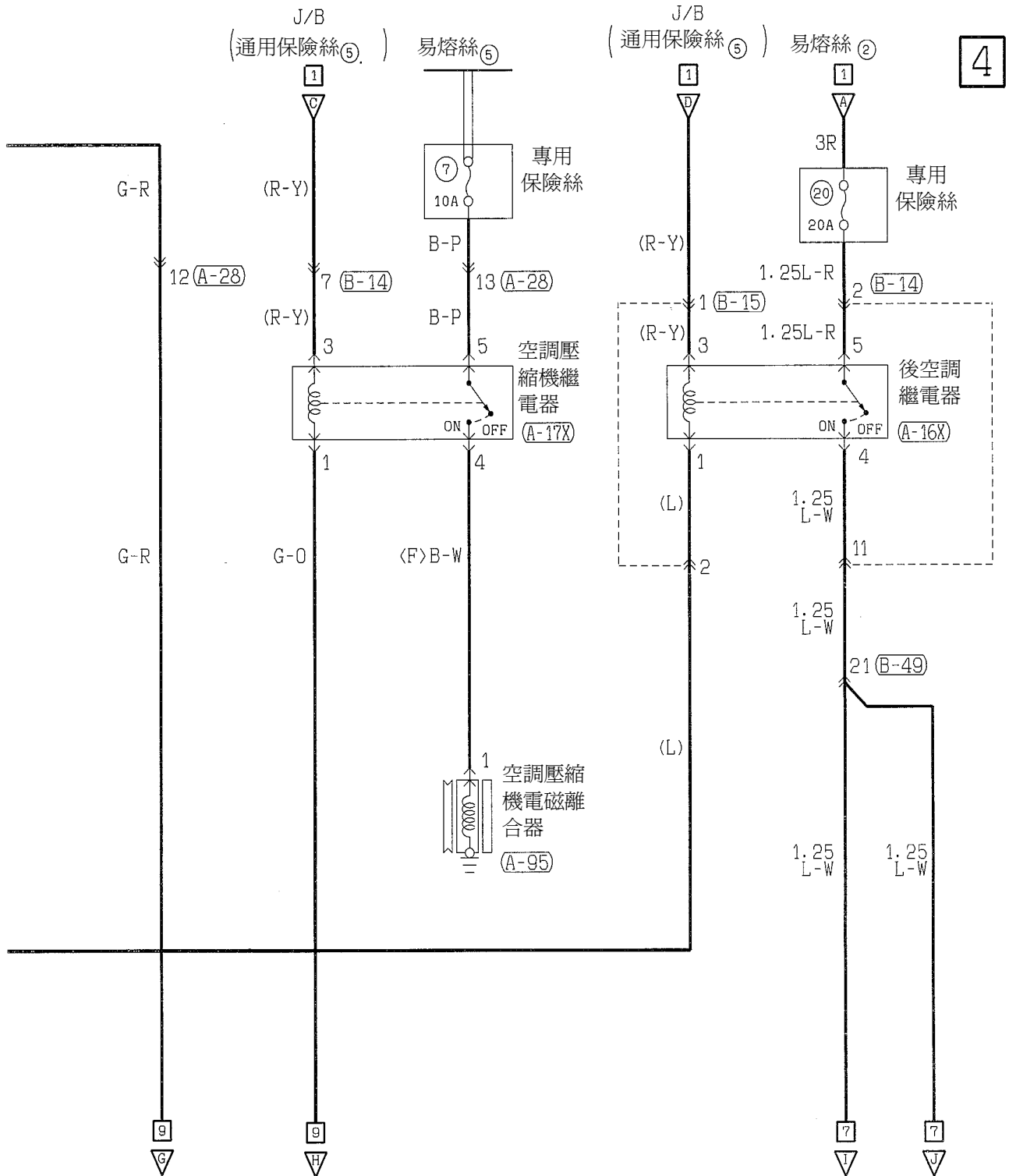

4

(B-15)

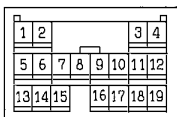

(B-66)

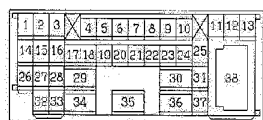

(B-74)

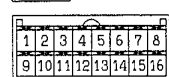

(B-75)

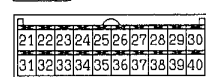

(B-76)

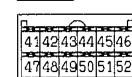

(A-16X)



自動空調系統(續)

5

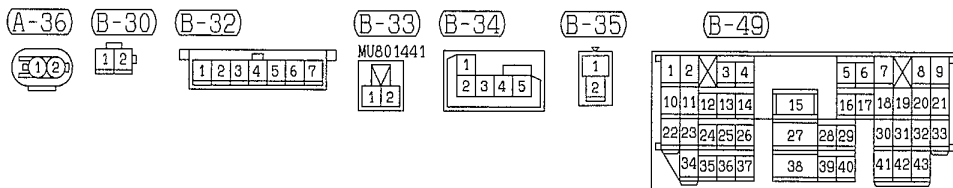
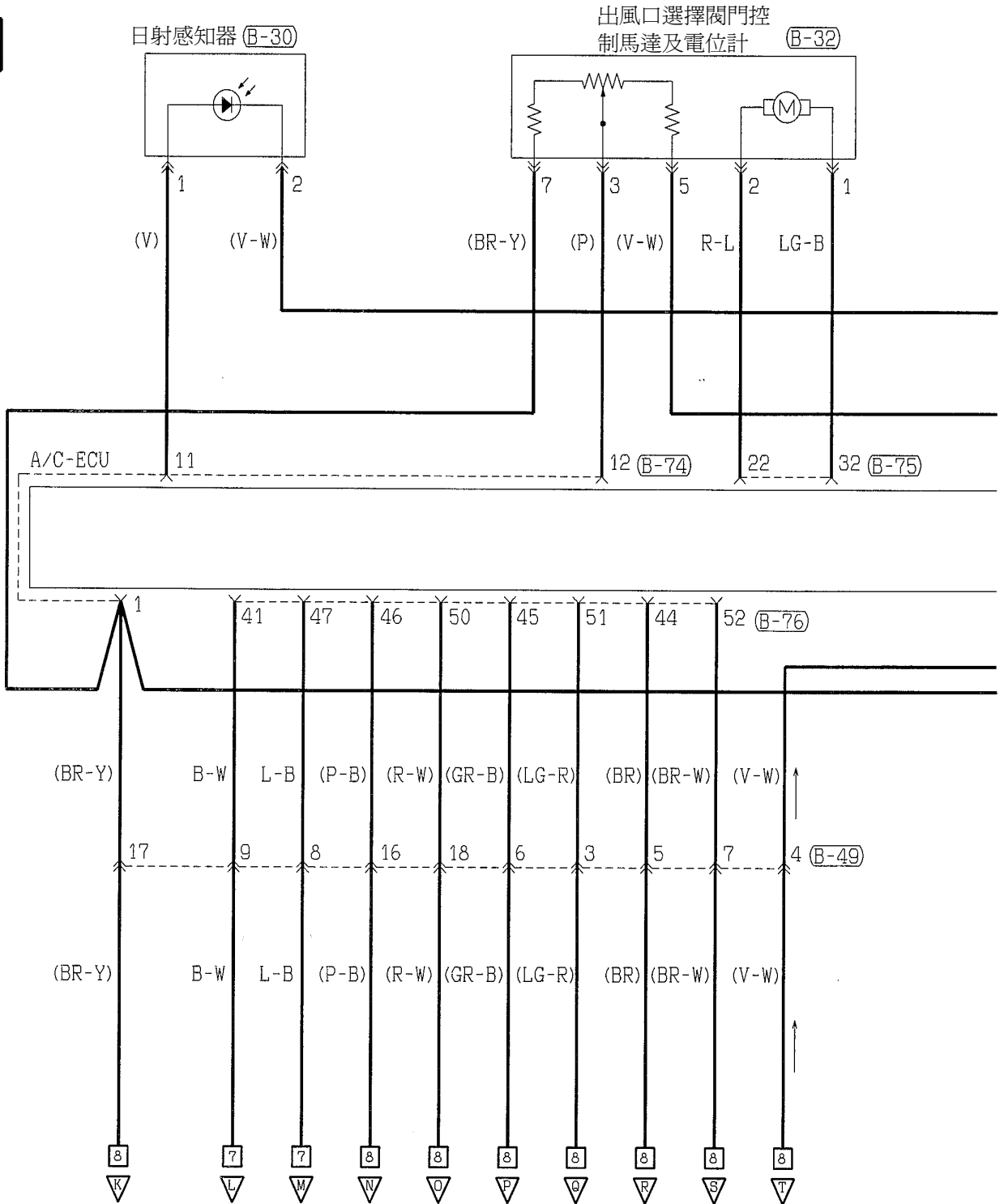

自動空調系統(續)

6

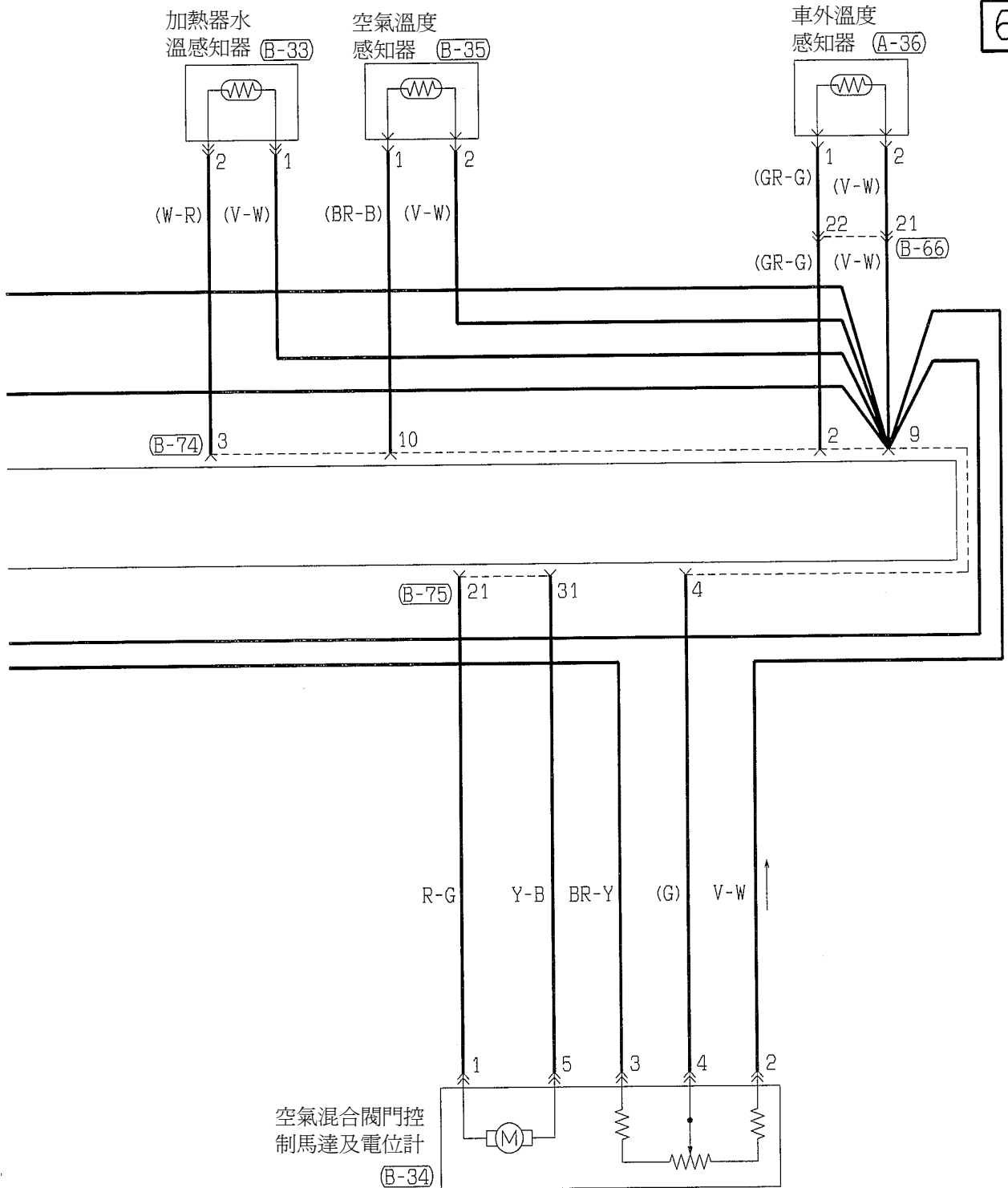

(B-66)

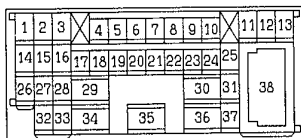

(B-74)

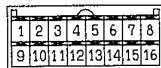

(B-75)

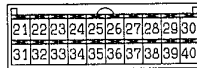

(B-76)

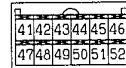

自動空調系統(續)

8

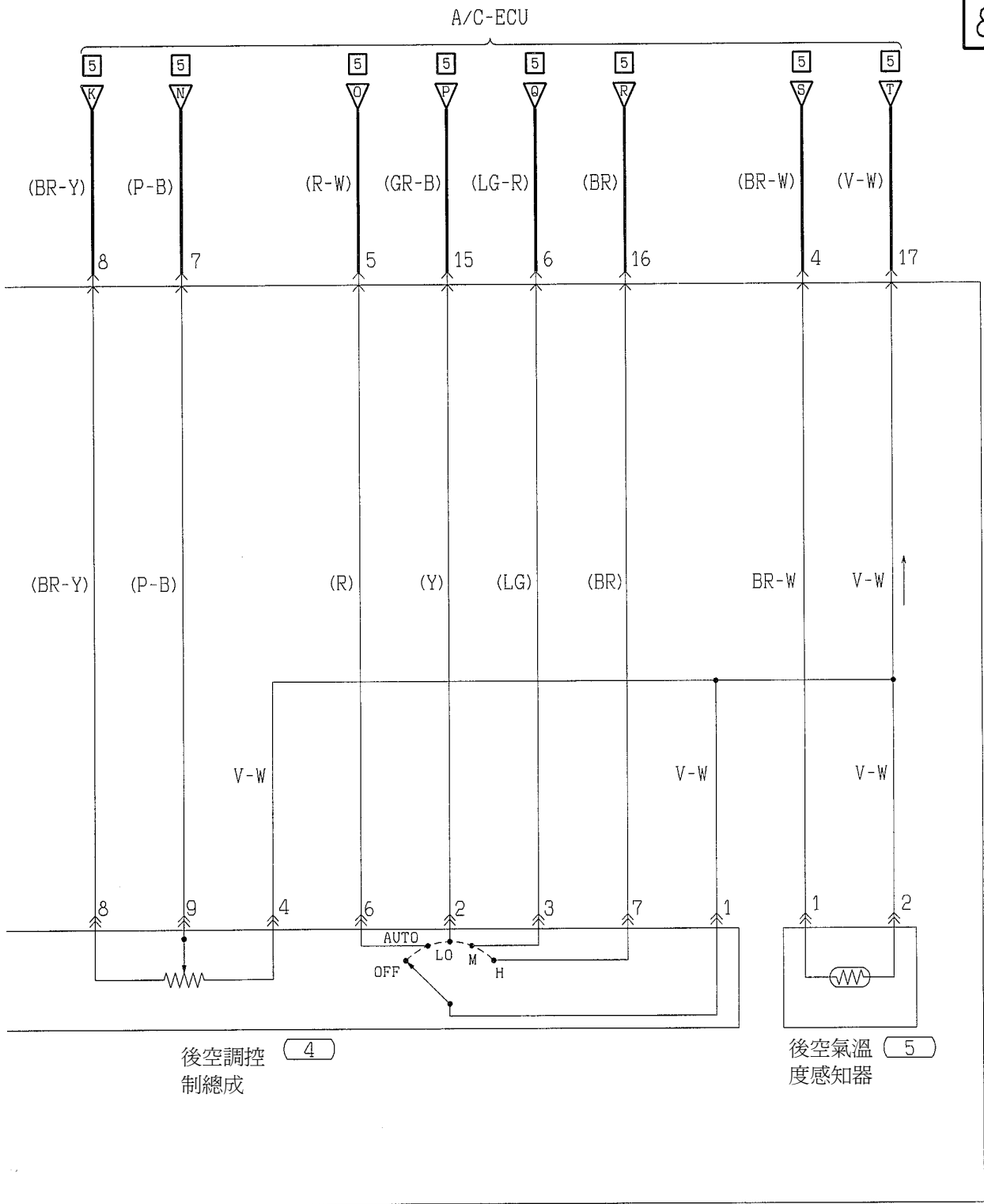

54D-106 DZL 迴路圖－自動空調系統

自動空調系統(續)

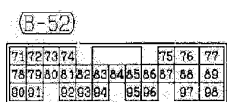
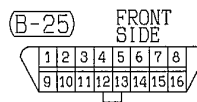
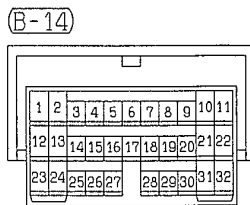
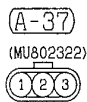
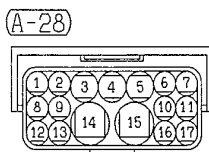
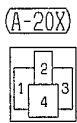
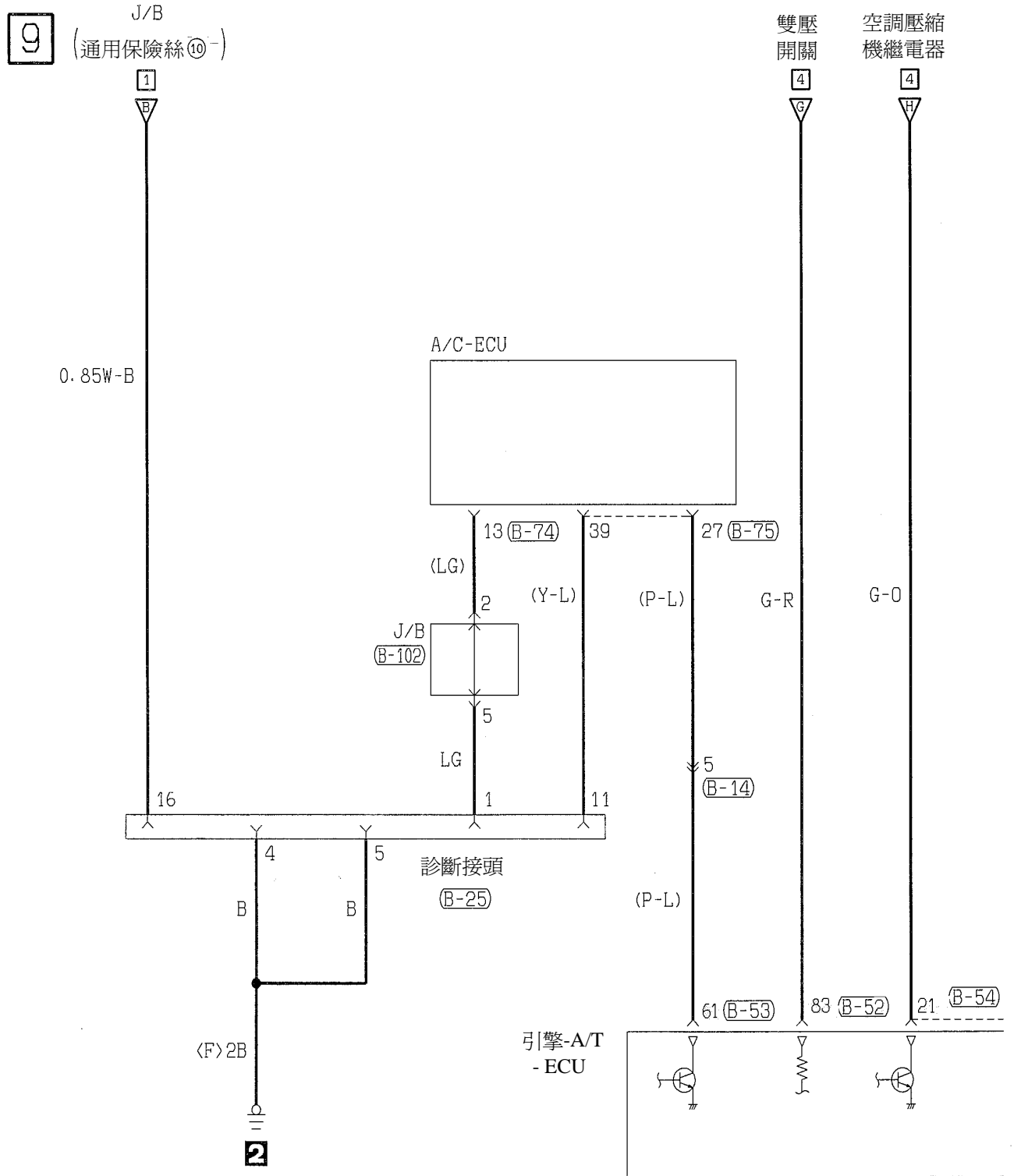

自動空調系統(續)

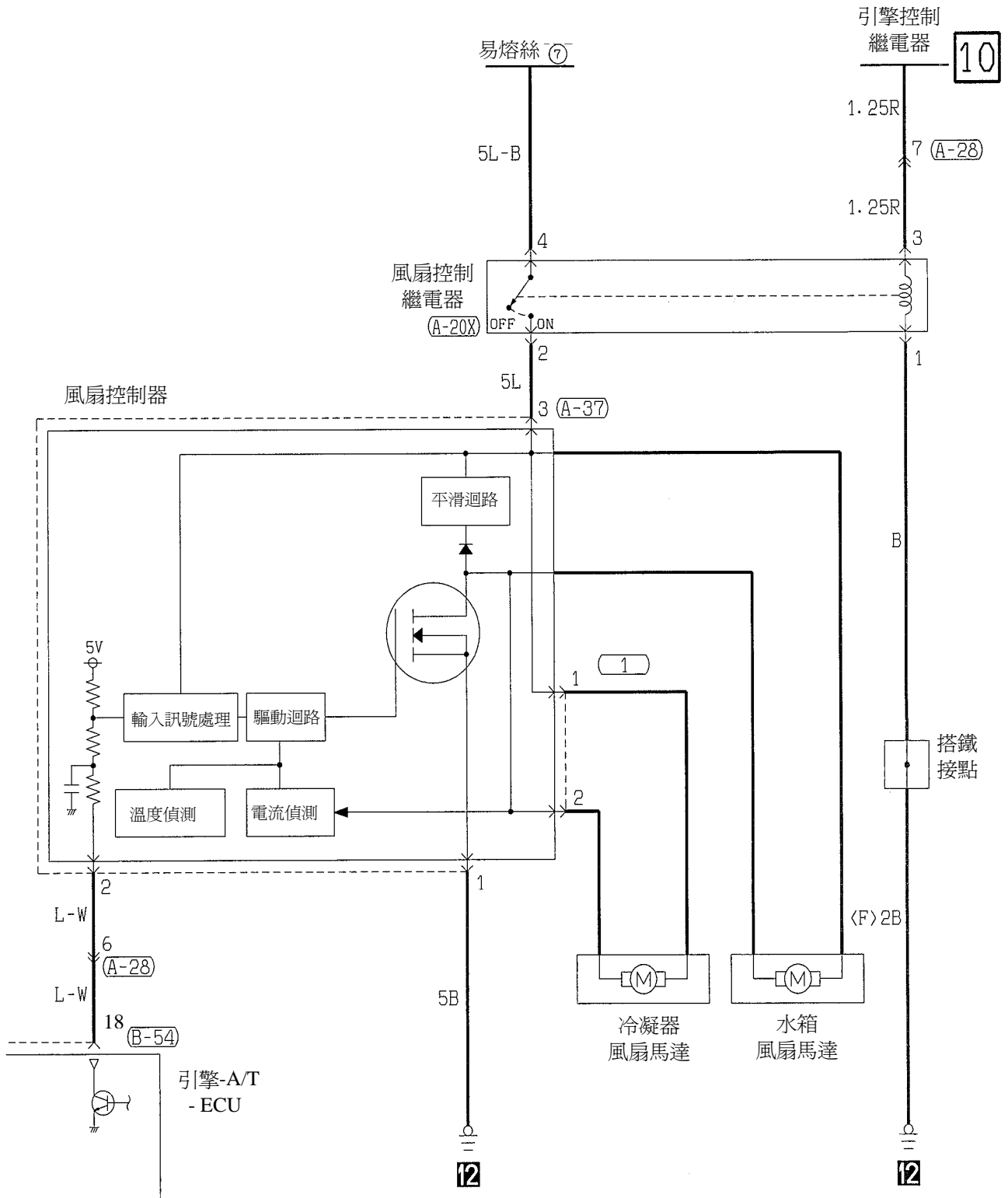

(B-53)

41	42	43	44	45	46
47	48	49	50	51	52
53	54	55	56	57	
58	59	60	61	62	63
64	65	66			

(B-54)

1	2	3	4	5	6	7	8
9	10	11	12	13	14	15	16
17	18	19	20	21	22	23	
24	25	26	27	28	29	30	31
32	33	34	35				

(B-74) (MU801584)

1	2	3	4	5	6	7	8
9	10	11	12	13	14	15	16

(B-75) (MU801585)

21	22	23	24	25	26	27	28	29	30
31	32	33	34	35	36	37	38	39	40

(B-102)

1	2	3	4	5
6	7	8	9	10

(1)

1	2
---	---

54D-108 DZL 迴路圖—前雨刷及噴水器

前擋風玻璃雨刷及噴水器

1

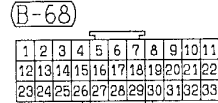
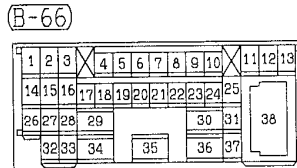
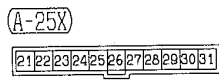
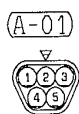
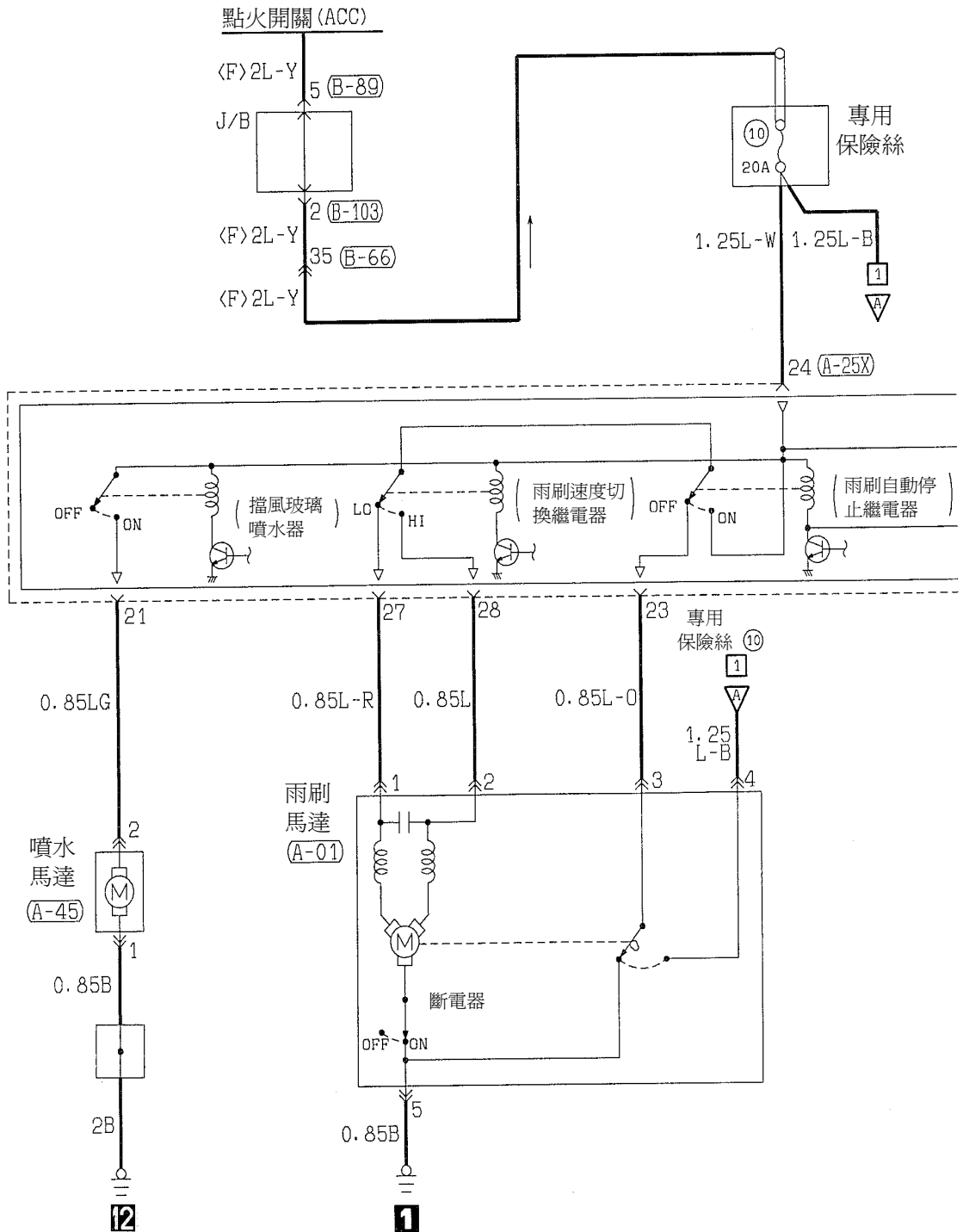

前擋風玻璃雨刷及噴水器

2

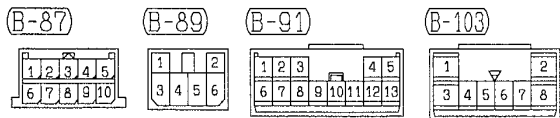
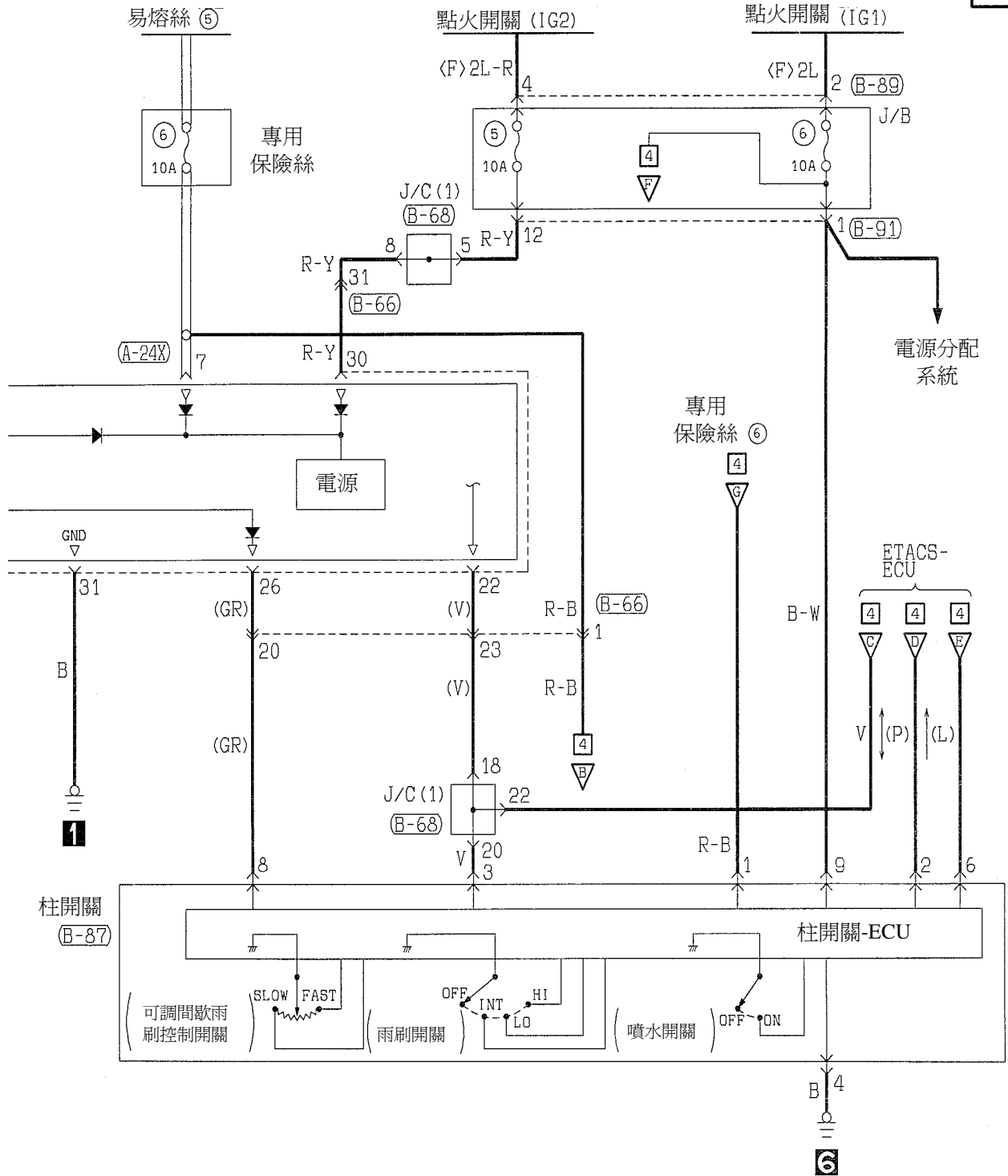

54D-110 DZL 迴路圖－前雨刷及噴水器

前擋風玻璃雨刷及噴水器(續)

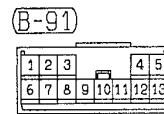
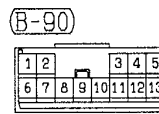
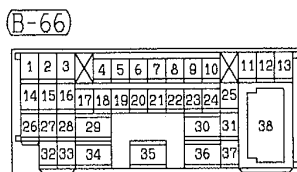
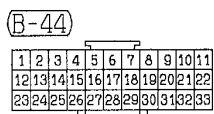
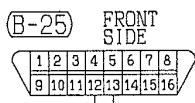
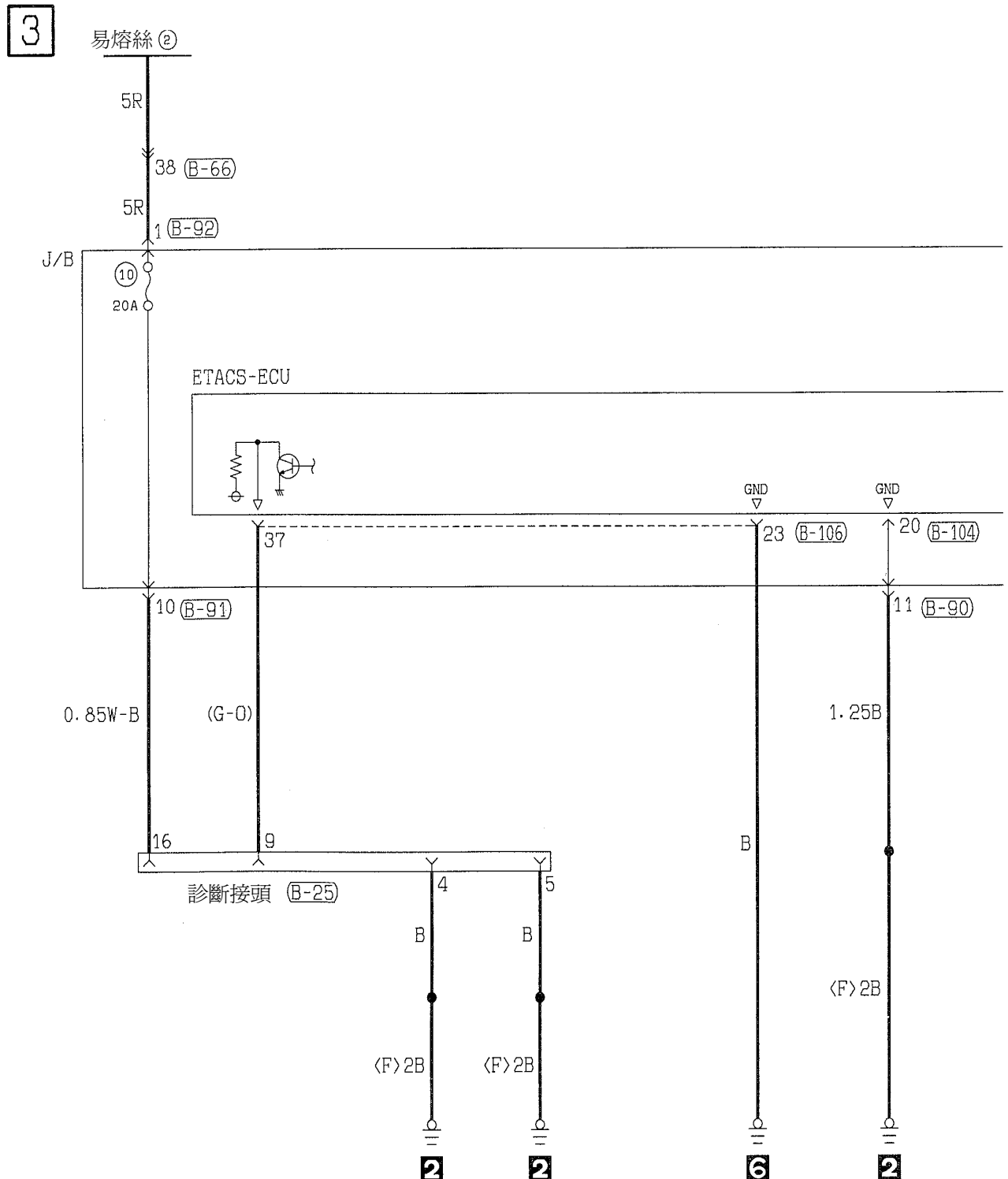

前擋風玻璃雨刷及噴水器(續)

4

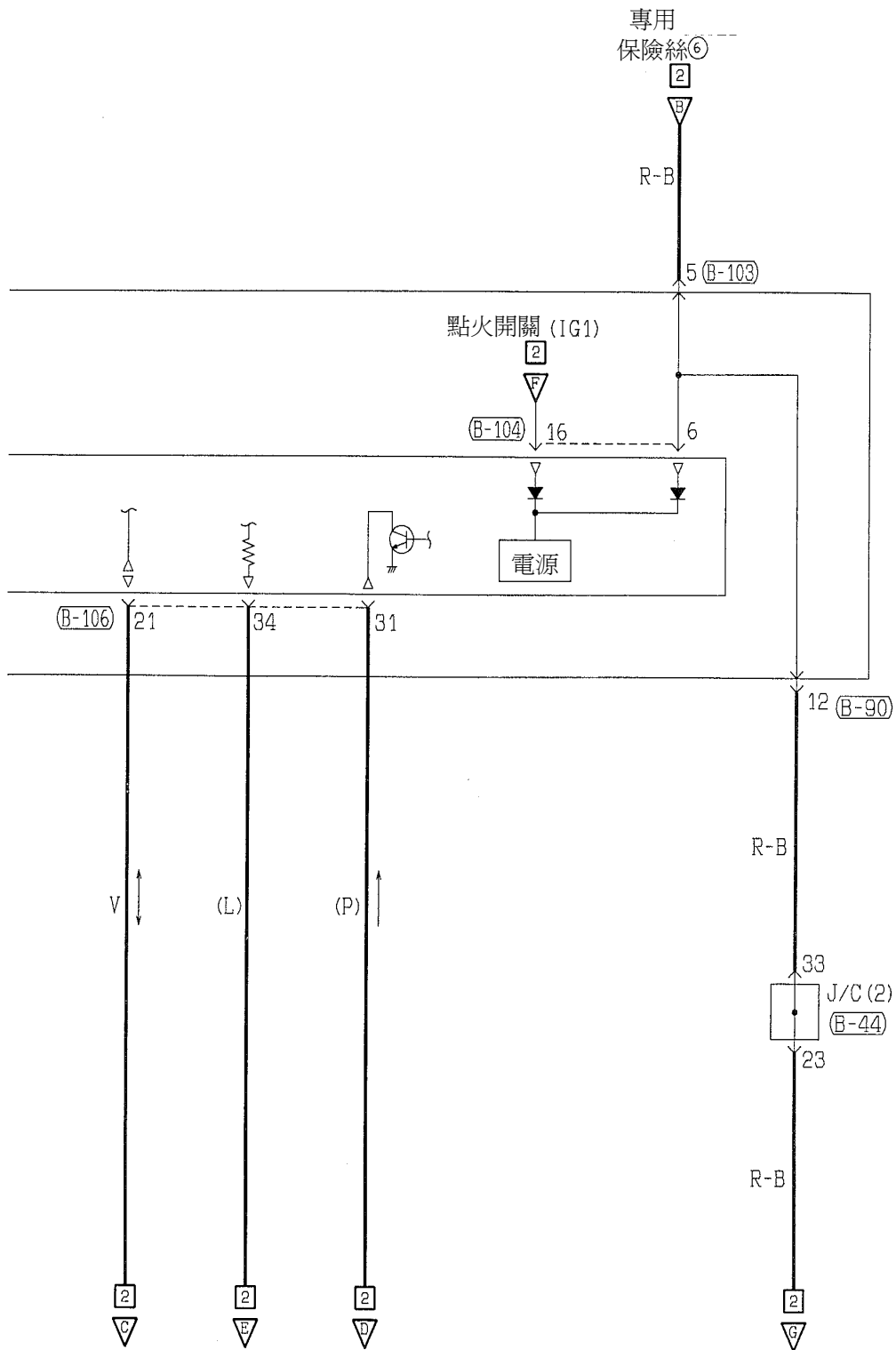

(B-103)

1	2
3	4
5	6
7	8

(B-104)

1	2	3	4	5	6	7	8	9	10	11	12	13	14	15	16	17	18	19	20
---	---	---	---	---	---	---	---	---	----	----	----	----	----	----	----	----	----	----	----

(B-106)

21	22	23	24	25	26	27	28	29	30
31	32	33	34	35	36	37	38	39	40

54D-112 DZL 迴路圖－前雨刷及噴水器

前擋風玻璃雨刷及噴水器(續)

5

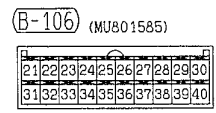
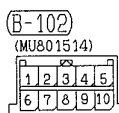
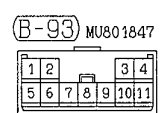
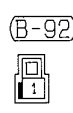
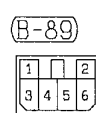
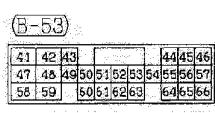
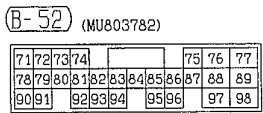
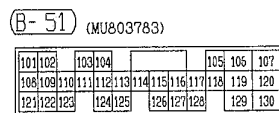
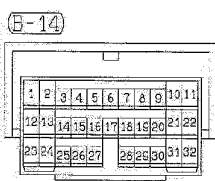
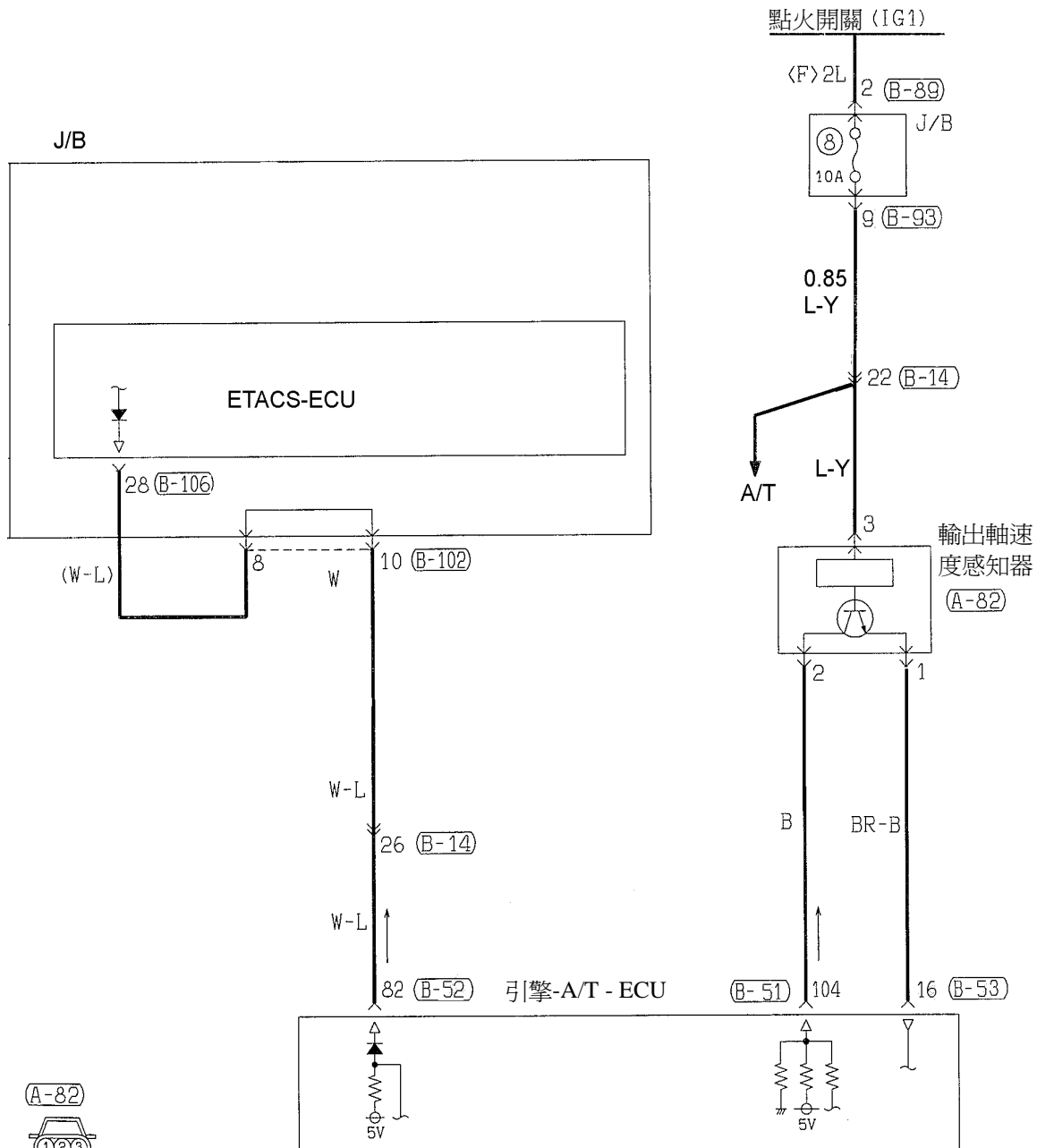

前擋風玻璃雨刷及噴水器(續)

備註

54D-114 DZL 迴路圖－後雨刷及噴水器

後擋風玻璃雨刷及噴水器

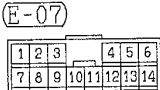
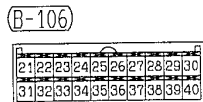
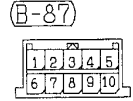
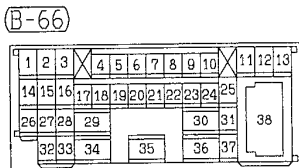
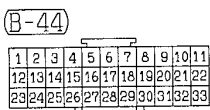
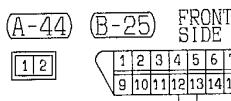
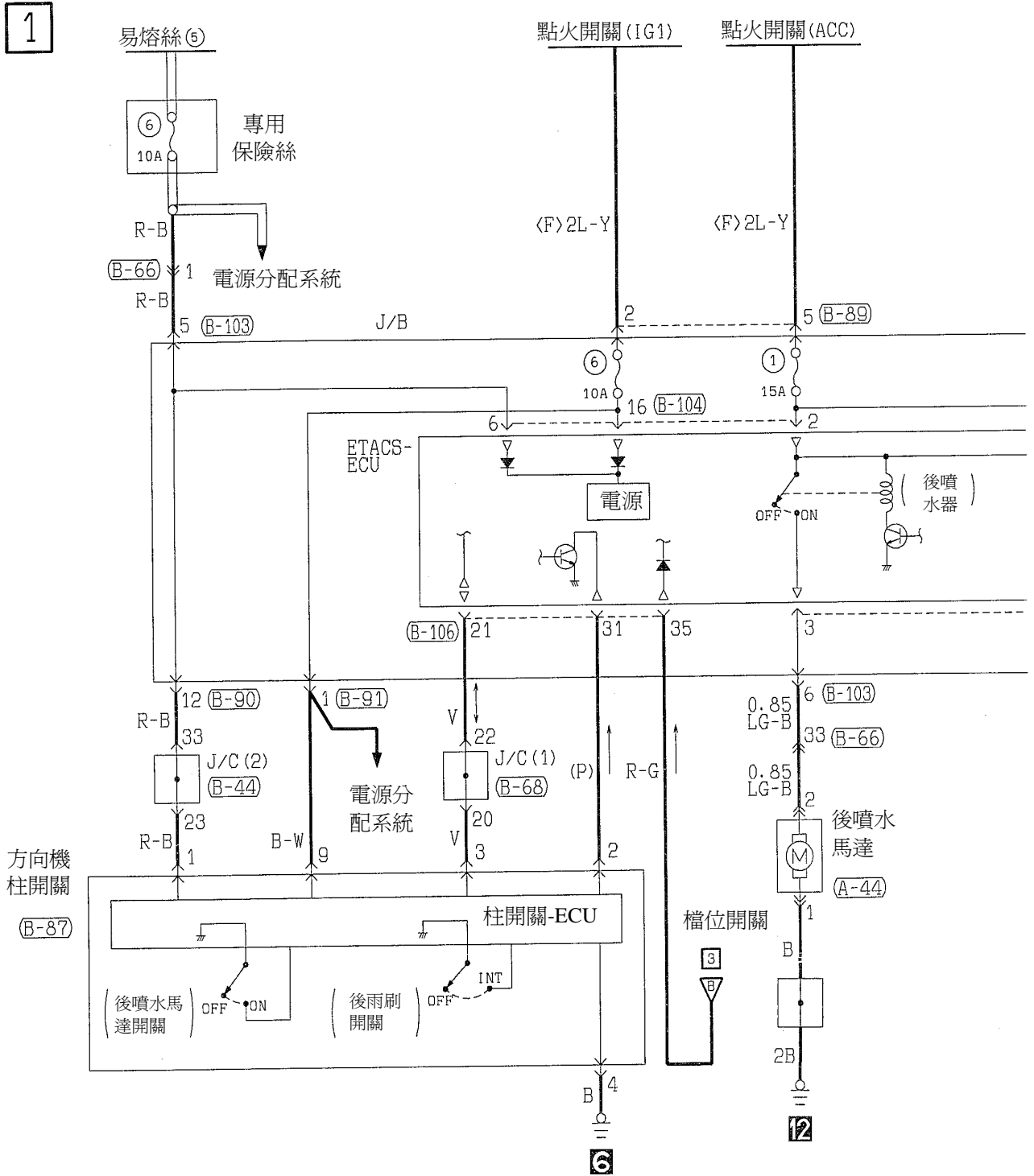

9N13X03AA

後擋風玻璃雨刷及噴水器

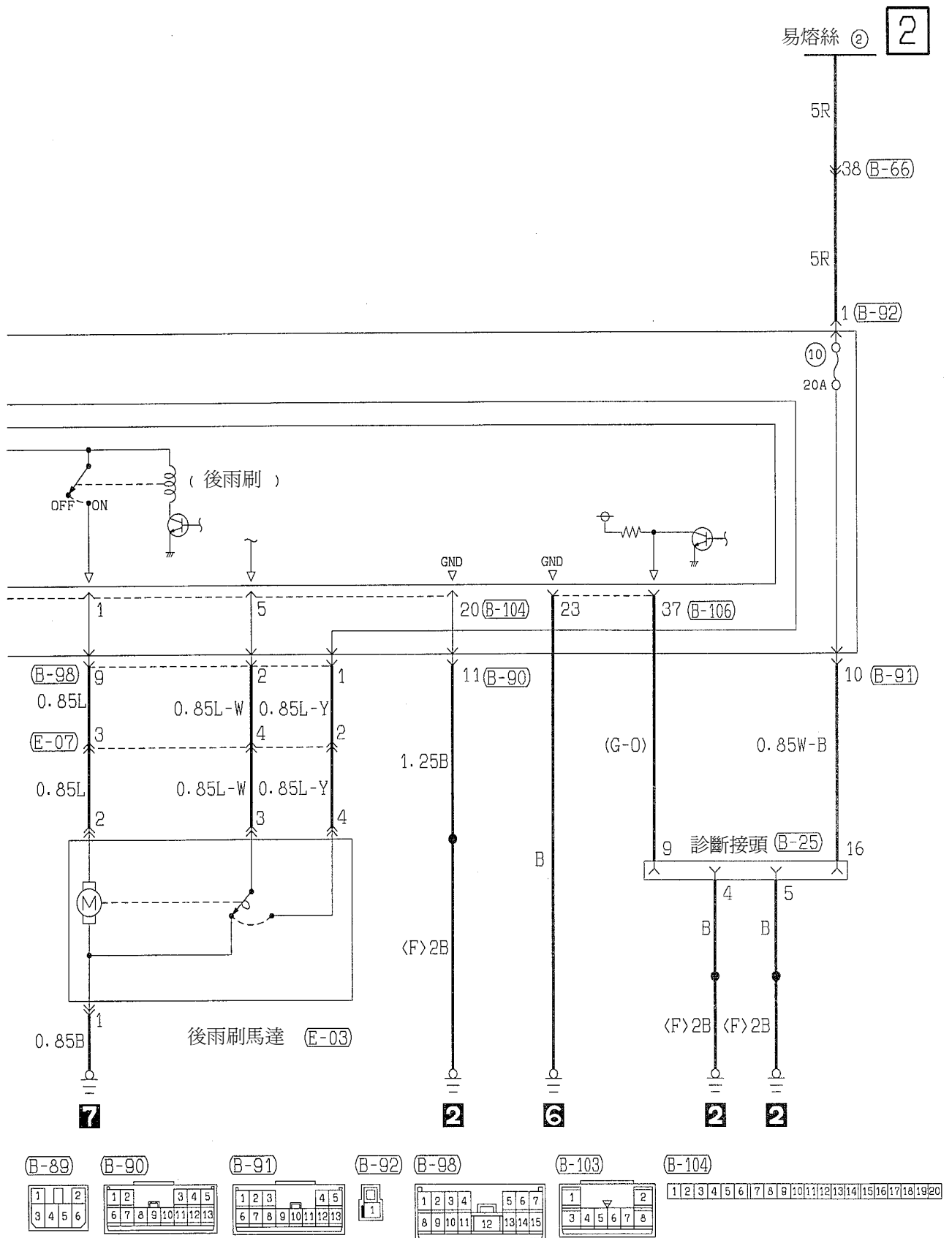

54D-116 DZL 迴路圖－後雨刷及噴水器

後擋風玻璃雨刷及噴水器(續)

3

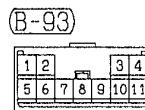
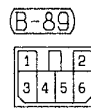
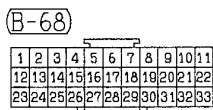
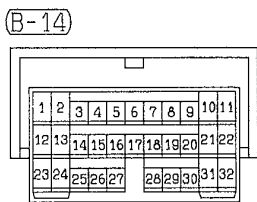
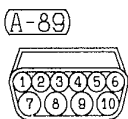
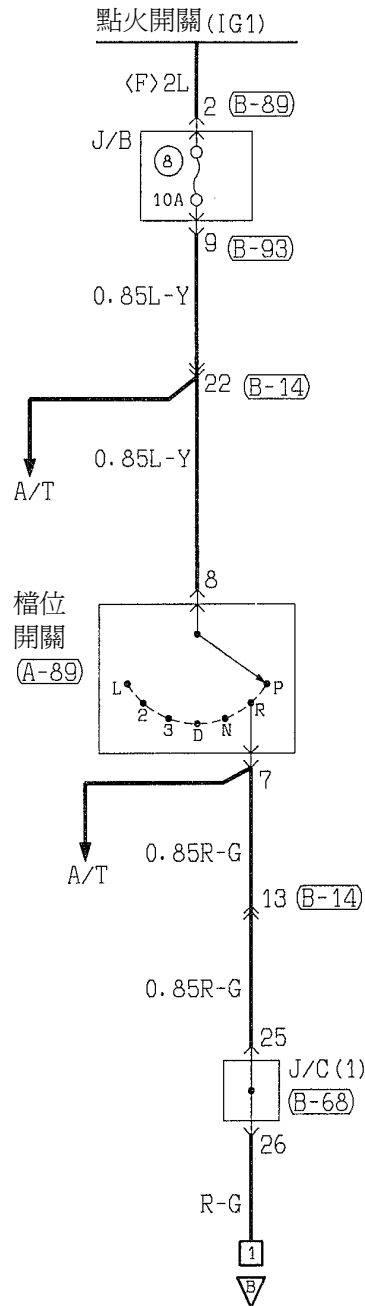

Wire colour code
 B : Black LG: Light green G : Green
 BR: Brown O : Orange GR: Gray
 W : White SB: Sky blue P : Pink
 V : Violet

L : Blue
 RL : Red
 Y : Yellow

9N13X03BA

後擋風玻璃雨刷及噴水器(續)

備註

電動摺疊式遙控後視鏡

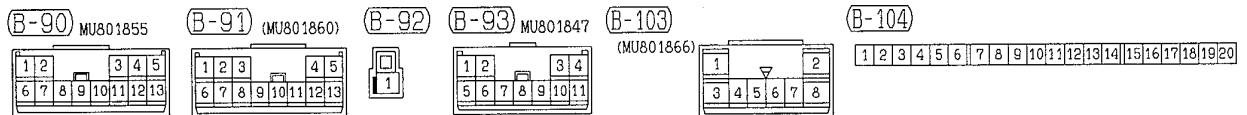
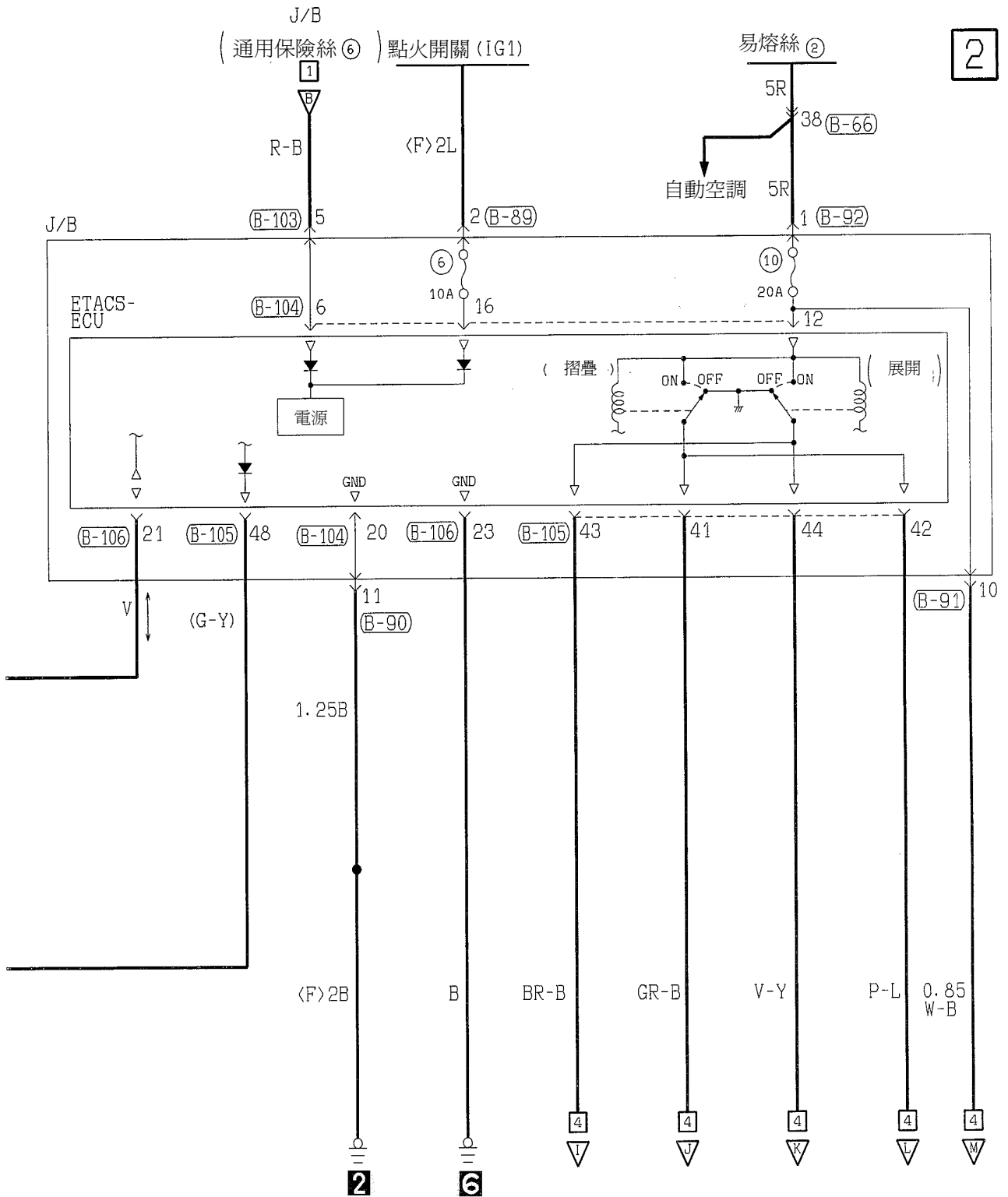

54D-120 DZL 迴路圖－電動遙控後視鏡

電動摺疊式遙控後視鏡(續)

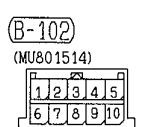
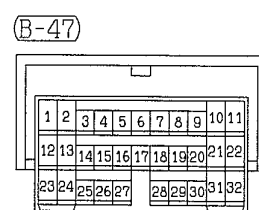
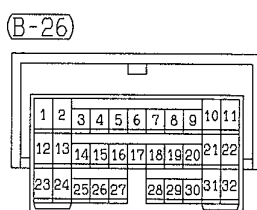
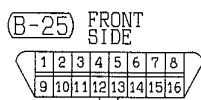
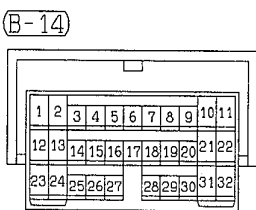
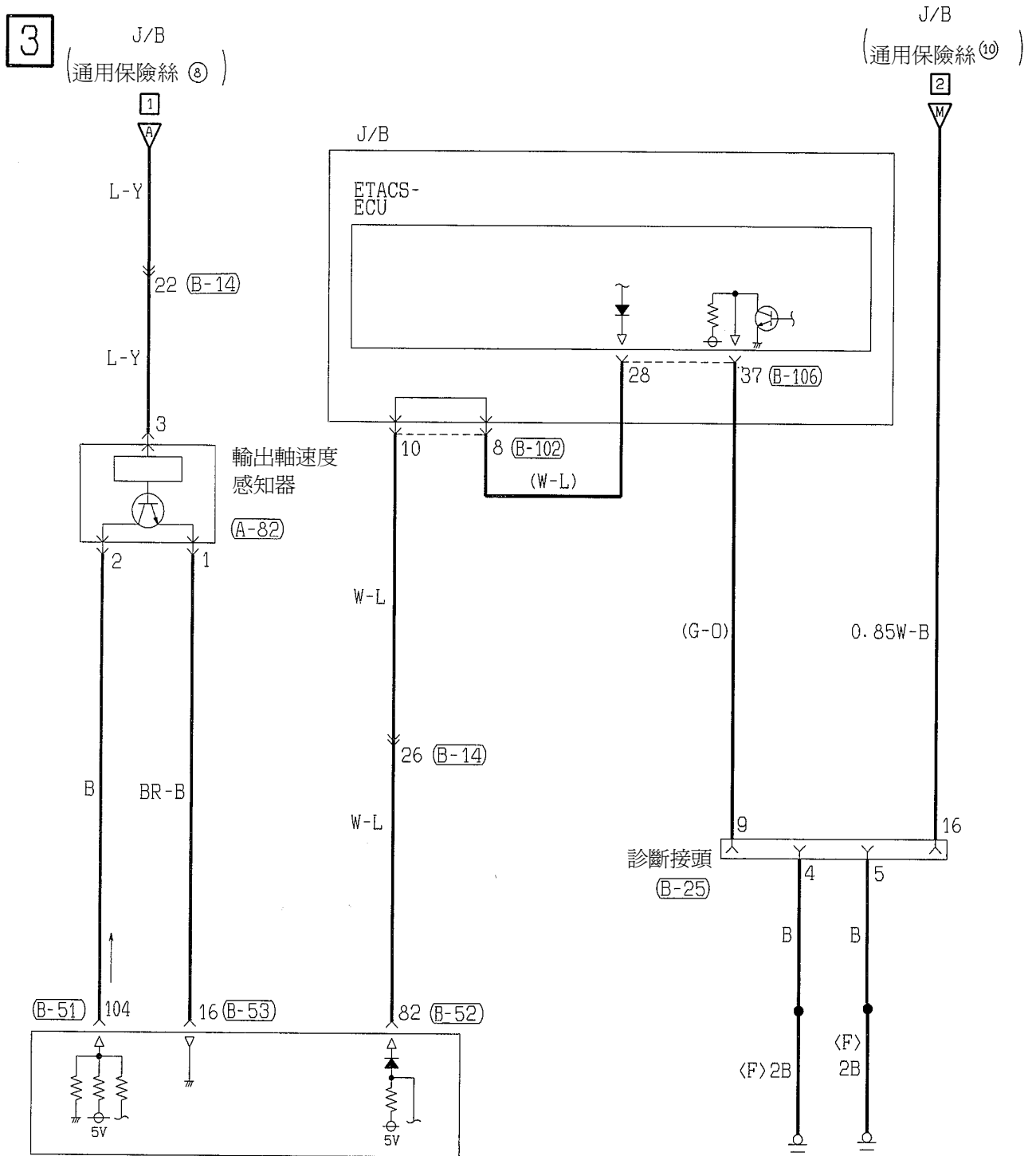

H1N13X01BA

電動摺疊式遙控後視鏡(續)

4

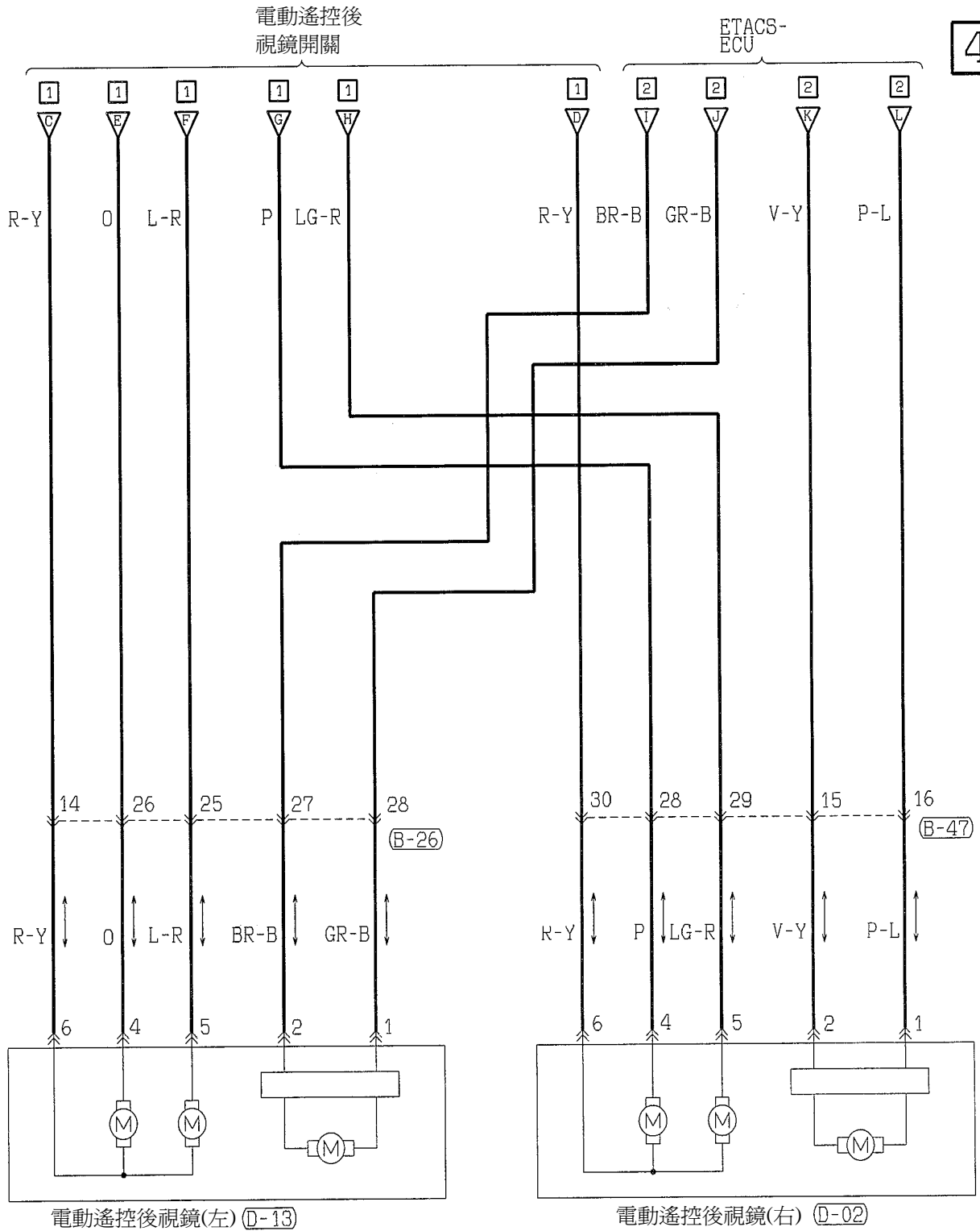

(B-106) (MU801585)

21	22	23	24	25	26	27	28	29	30
31	32	33	34	35	36	37	38	39	40

(B-51) (MU803783)

101	102	103	104	105	106	107						
108	109	110	111	112	113	114	115	116	117	118	119	120
121	122	123	124	125	126	127	128	129	130			

(B-52) (MU803782)

71	72	73	74	75	76	77					
78	79	80	81	82	83	84	85	86	87	88	89
90	91	92	93	94	95	96	97	98			

(B-53)

41	42	43	44	45	46					
47	48	49	50	51	52	53	54	55	56	57
58	59	60	61	62	63	64	65	66		

(D-02)

1	2	3	
4	5	6	7

(D-13)

1	2	3	
4	5	6	7

54D-122 DZL 迴路圖－後擋及後視鏡除霧

後擋風玻璃及後視鏡除霧

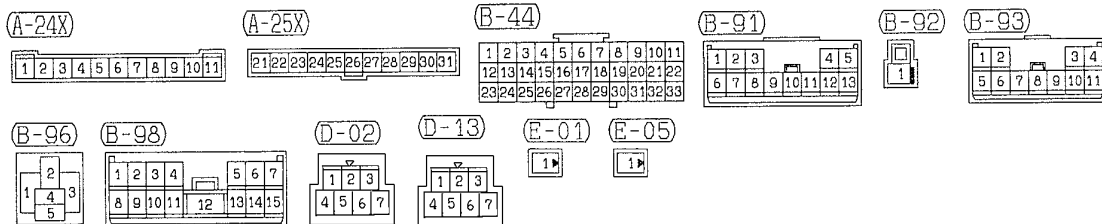
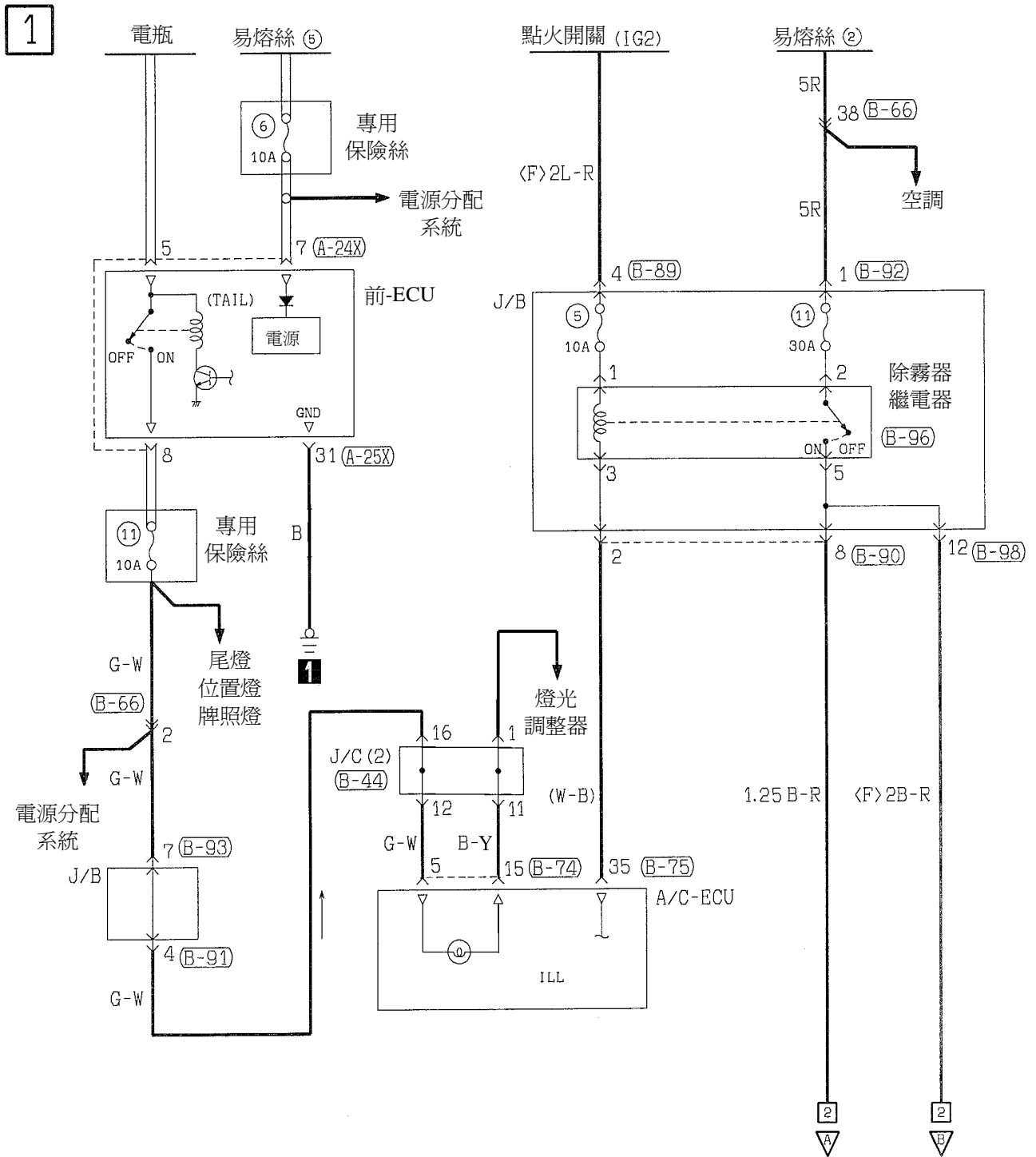

9N13X08AA

DZL 迴路圖－後擋及後視鏡除霧 54D-123

後擋風玻璃及後視鏡除霧

2

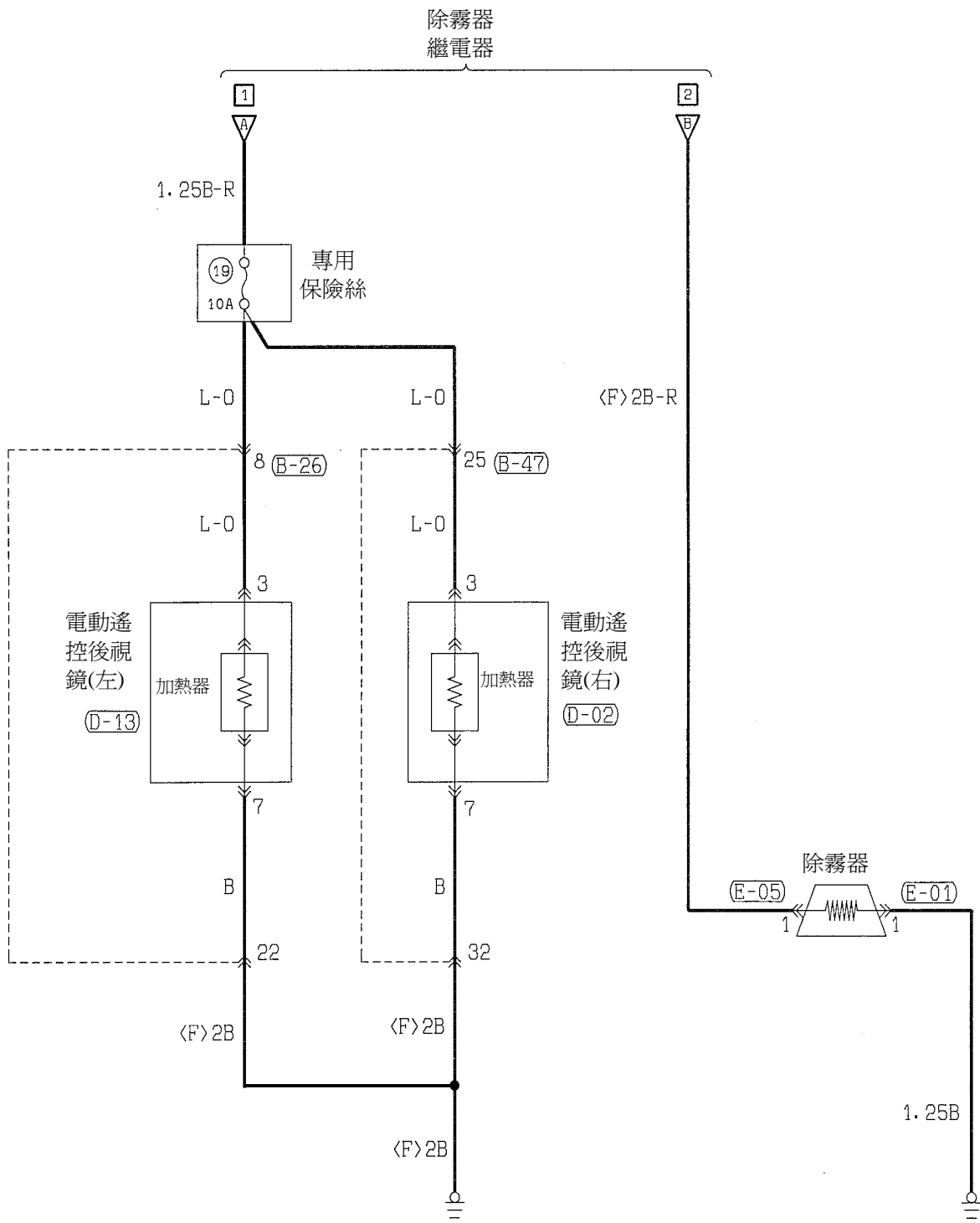

2

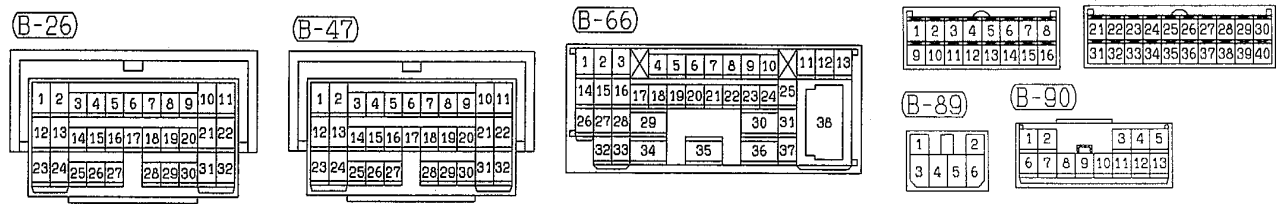

SRS

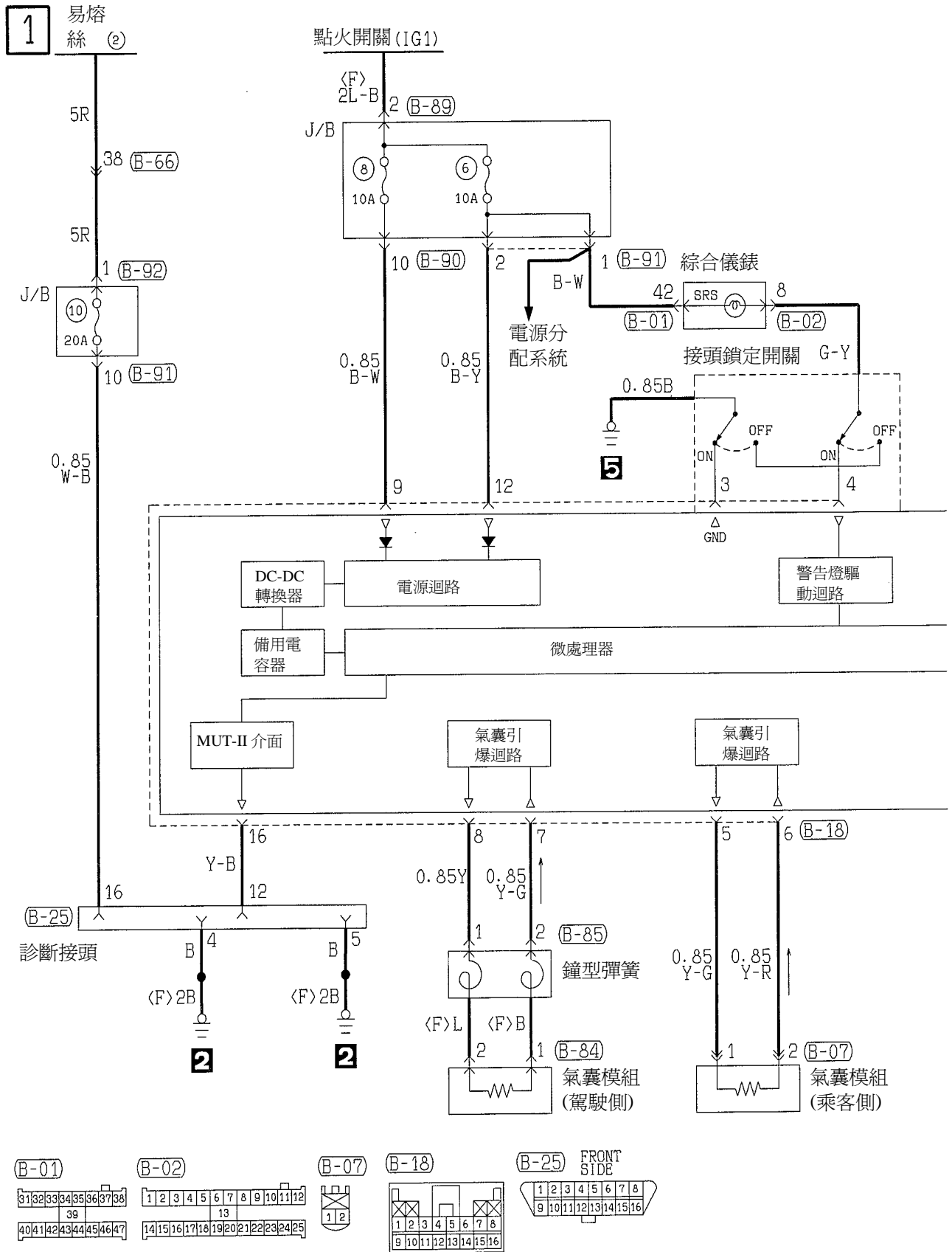

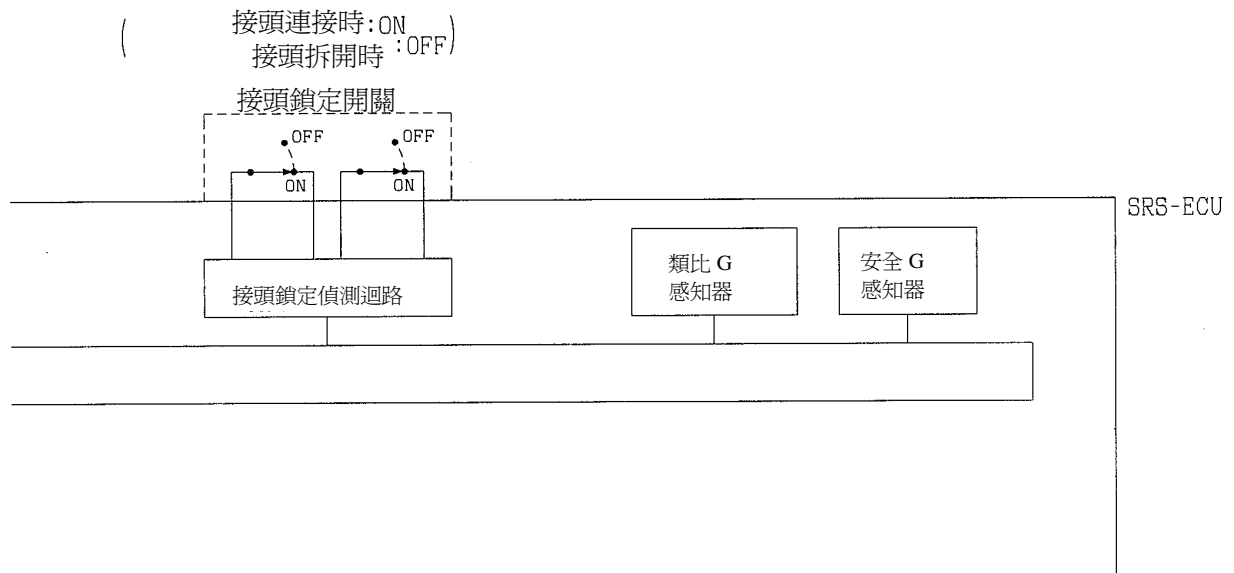

(B-66)

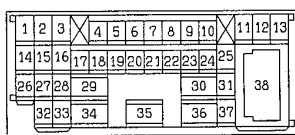

(B-84)



(B-85)



(B-89)



(B-90)

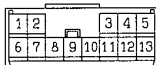

(B-91)

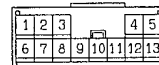

(B-92)



54D-126 DZL 迴路圖－防鎖死剎車系統

防鎖死剎車系統(ABS)

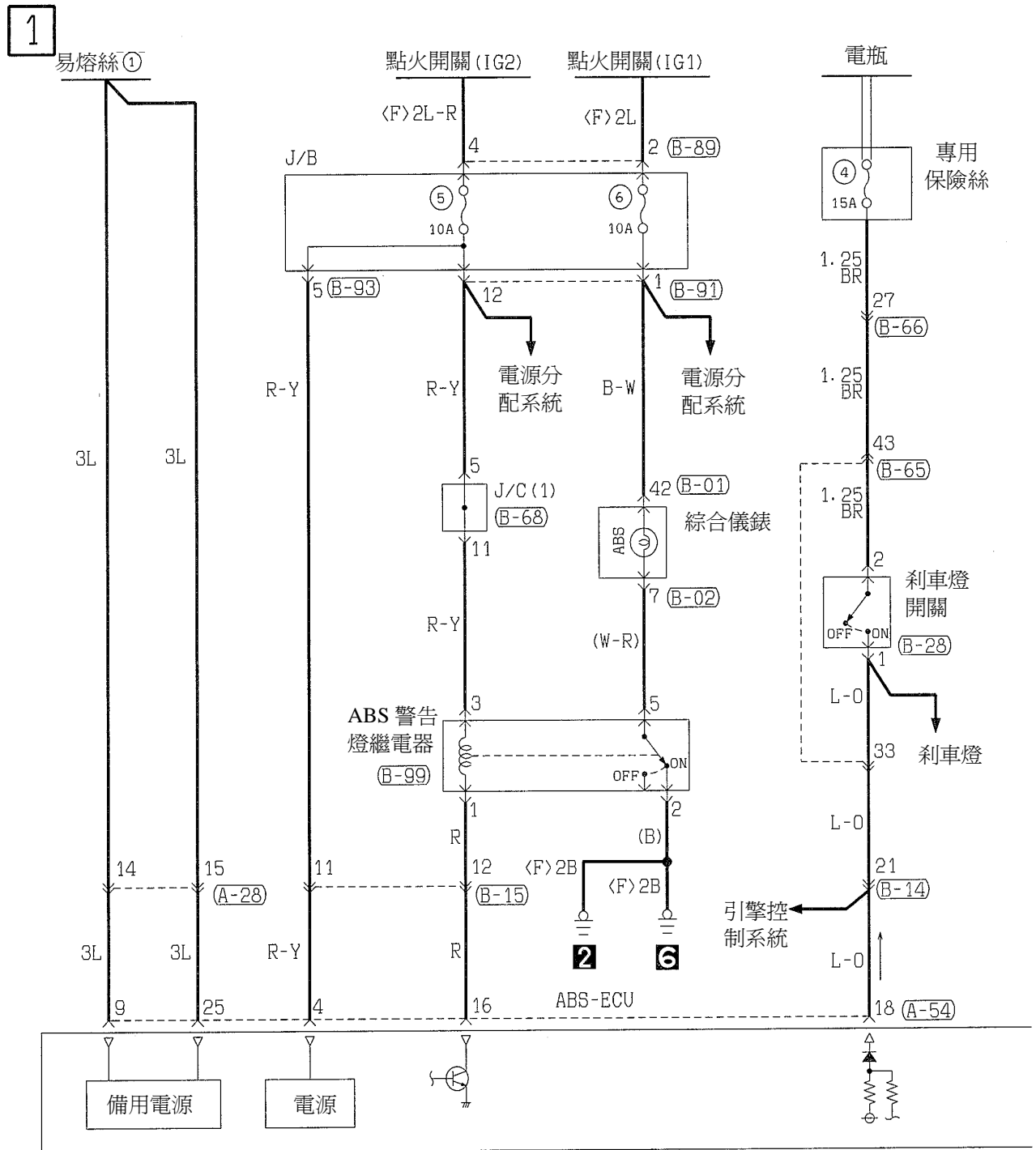

(A-28)

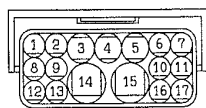

(A-54)

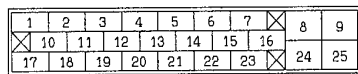

(B-01)

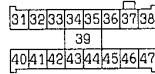

(B-02)

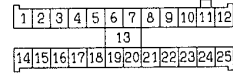

(B-28)



(B-93)

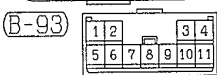

(B-99)

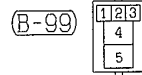

ON15X00AA

液壓單元

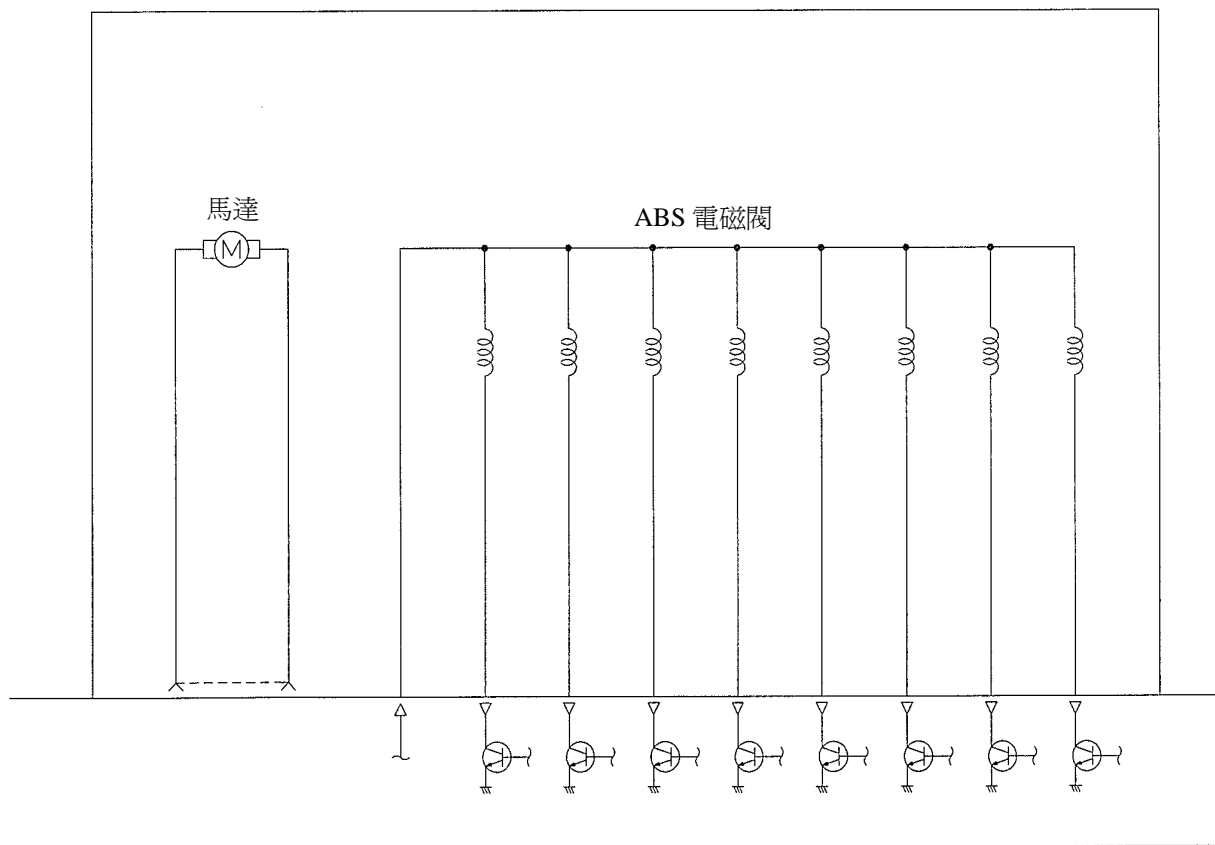

(B-14)

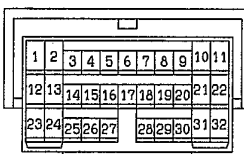

(B-15)

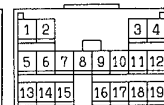

(B-65)

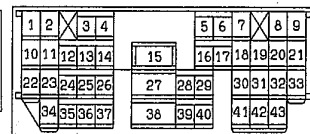

(B-66)

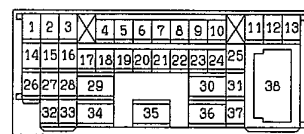

(B-68)



(B-89)



(B-91)

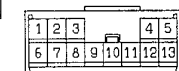

防鎖死剎車系統(ABS)(續)

3

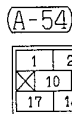
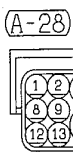
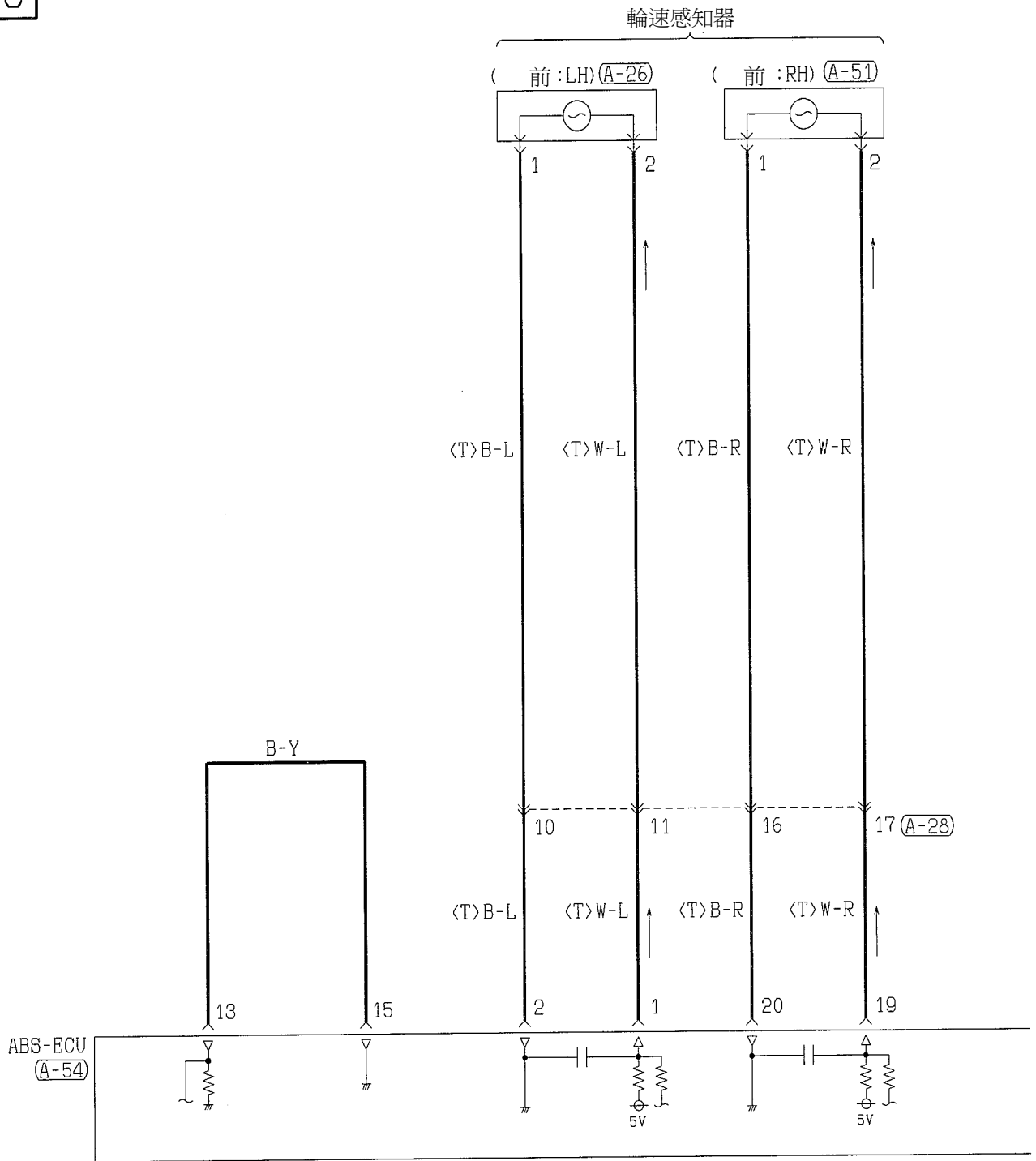

防鎖死剎車系統(ABS)(續)

4

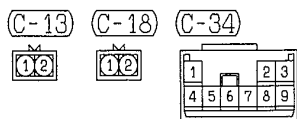
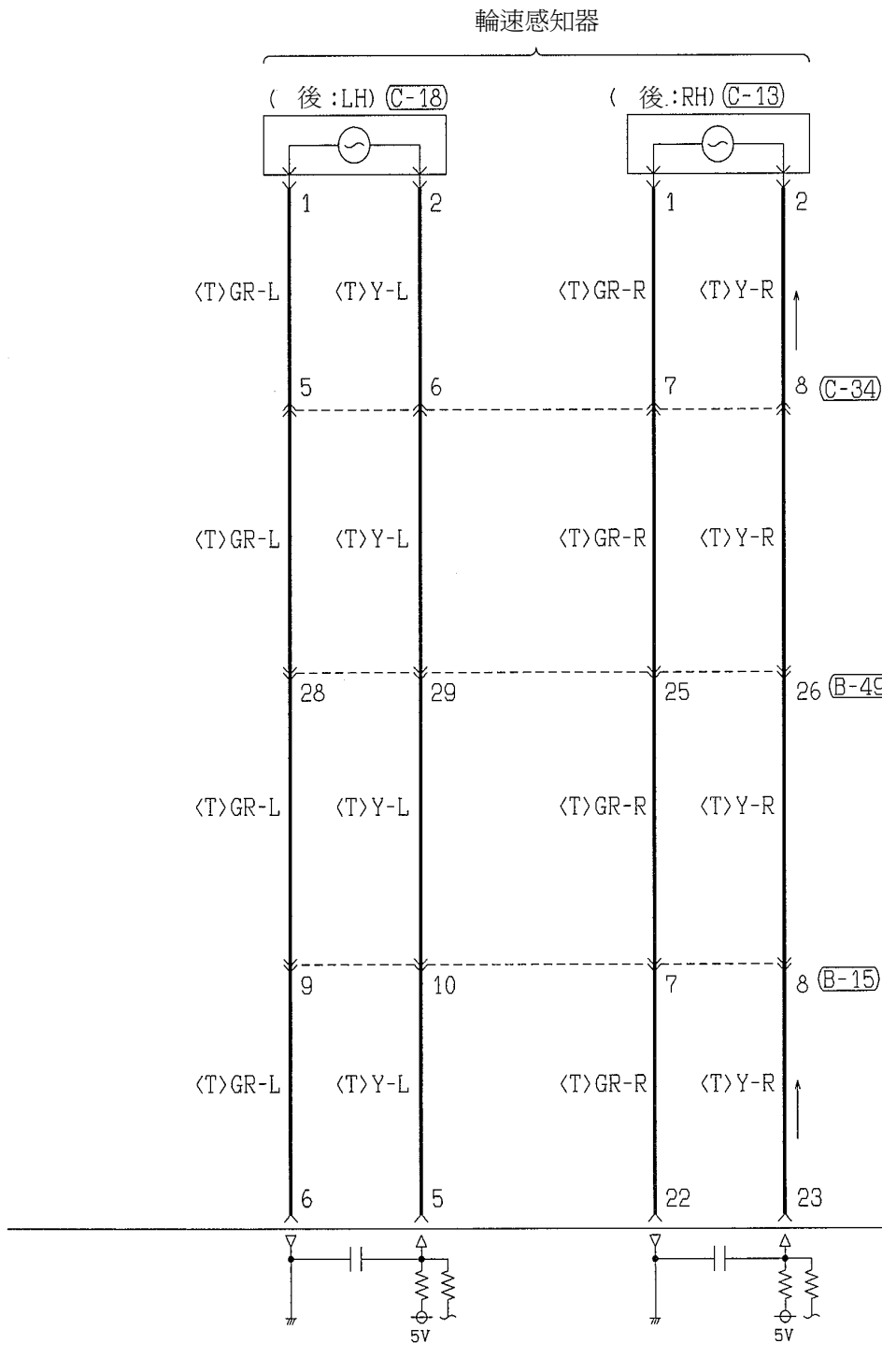

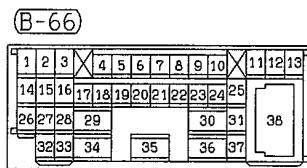
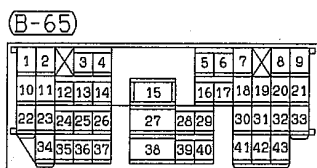
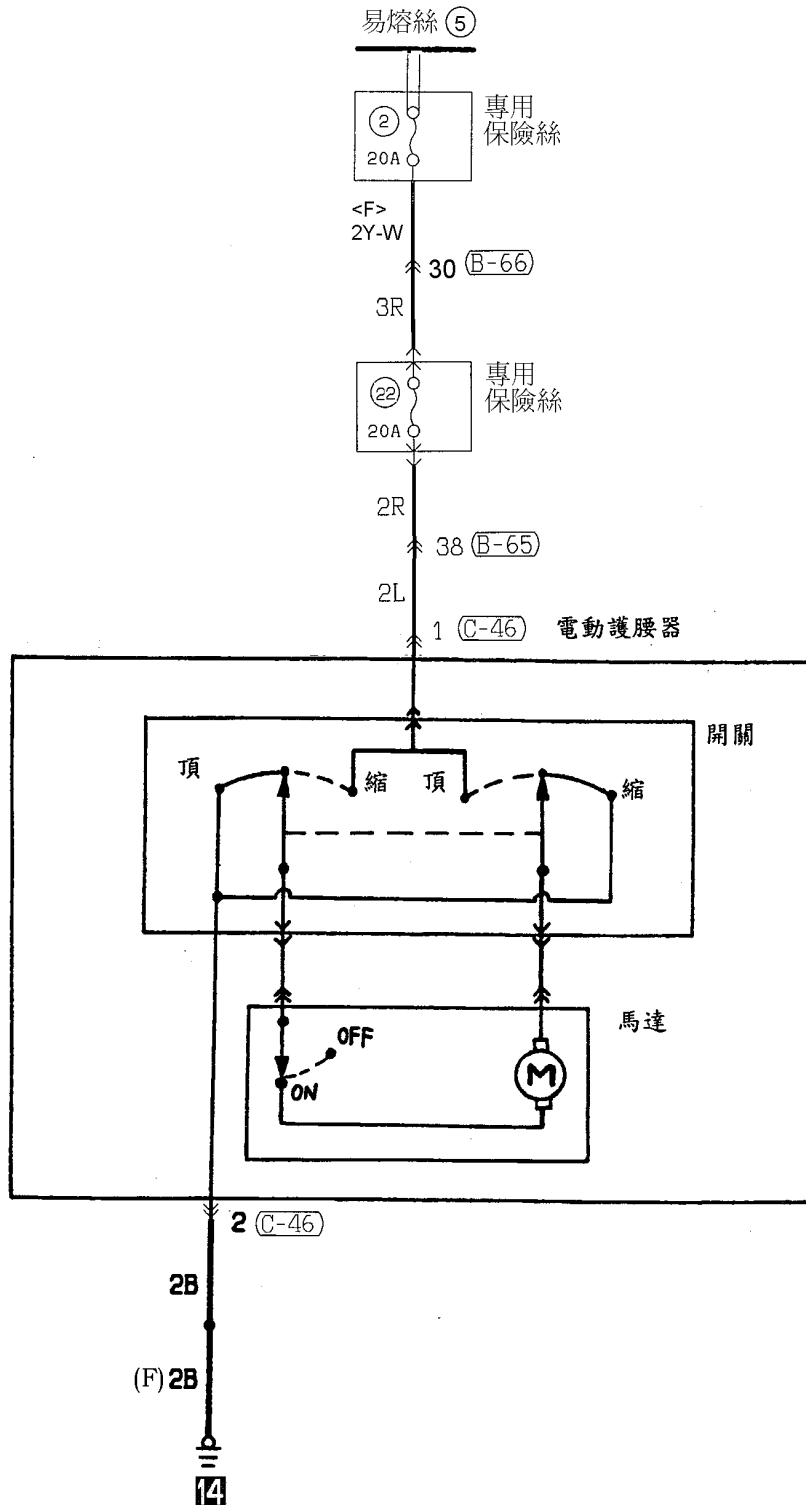

電動座椅

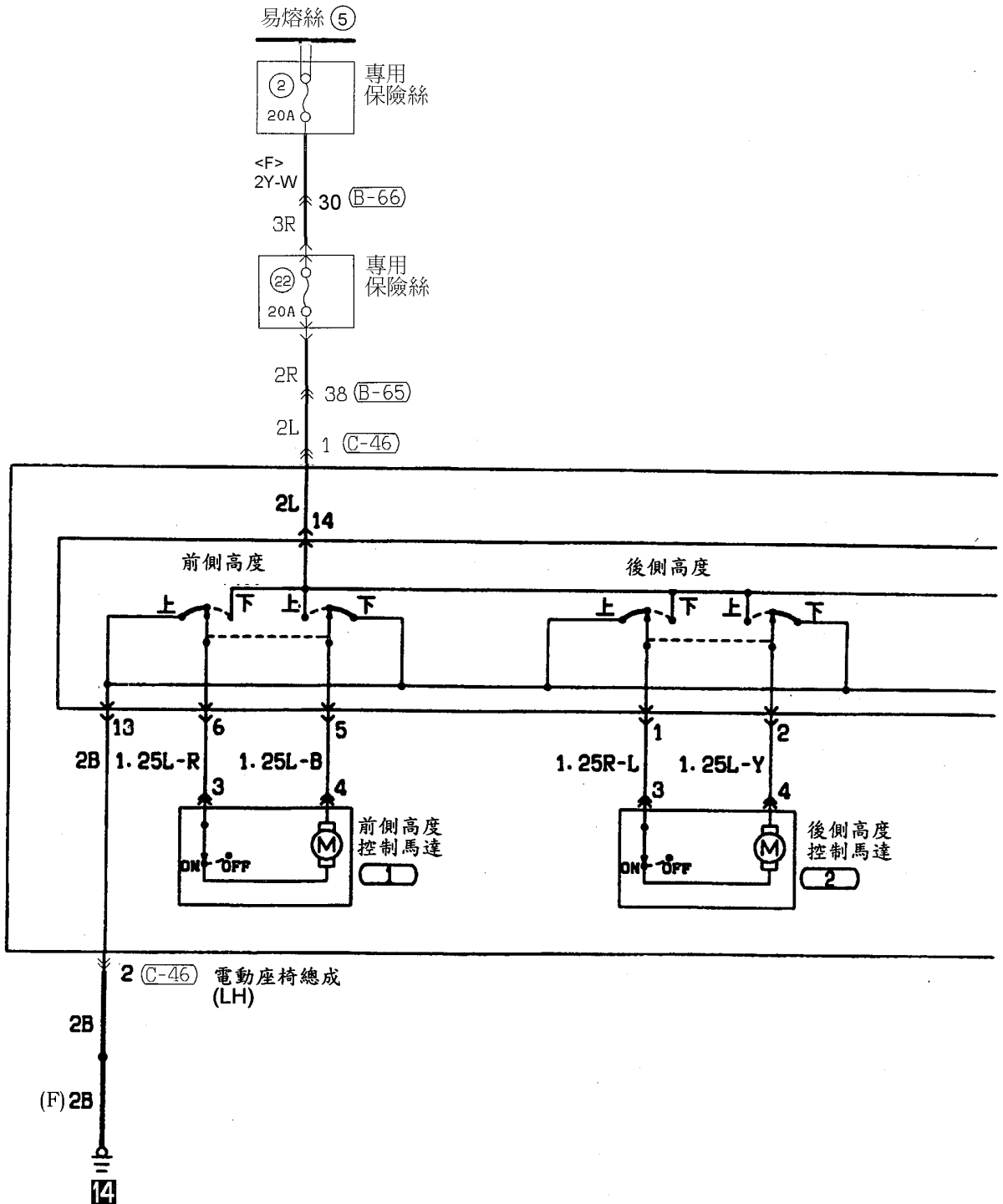

B-65

1	2	3	4		5	6	7	8	9		
10	11	12	13	14	15	16	17	18	19	20	21
22	23	24	25	26	27	28	29	30	31	32	33
34	35	36	37		38	39	40	41	42	43	

B-66

1	2	3	4	5	6	7	8	9	10	11	12	13
14	15	16	17	18	19	20	21	22	23	24	25	
26	27	28	29		30	31						
32	33	34		35		36	37					

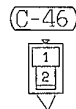

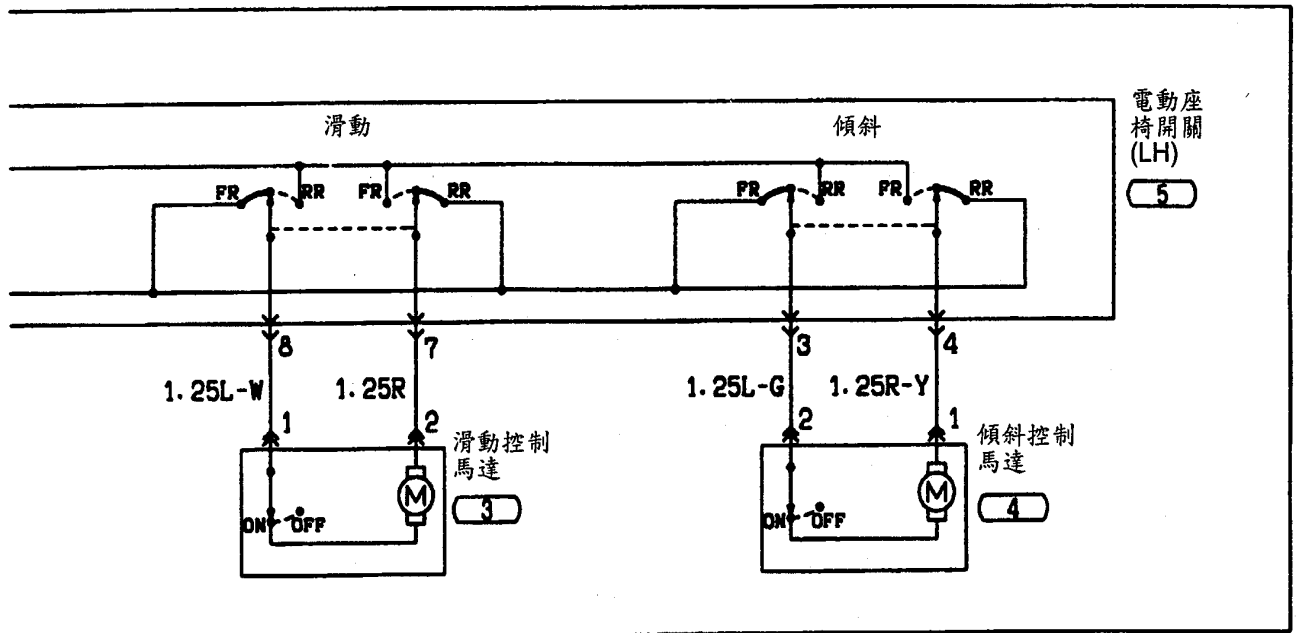

54D-134 DZL 迴路圖－儀錶燈光亮度調整器

儀錶燈光亮度調整器

1

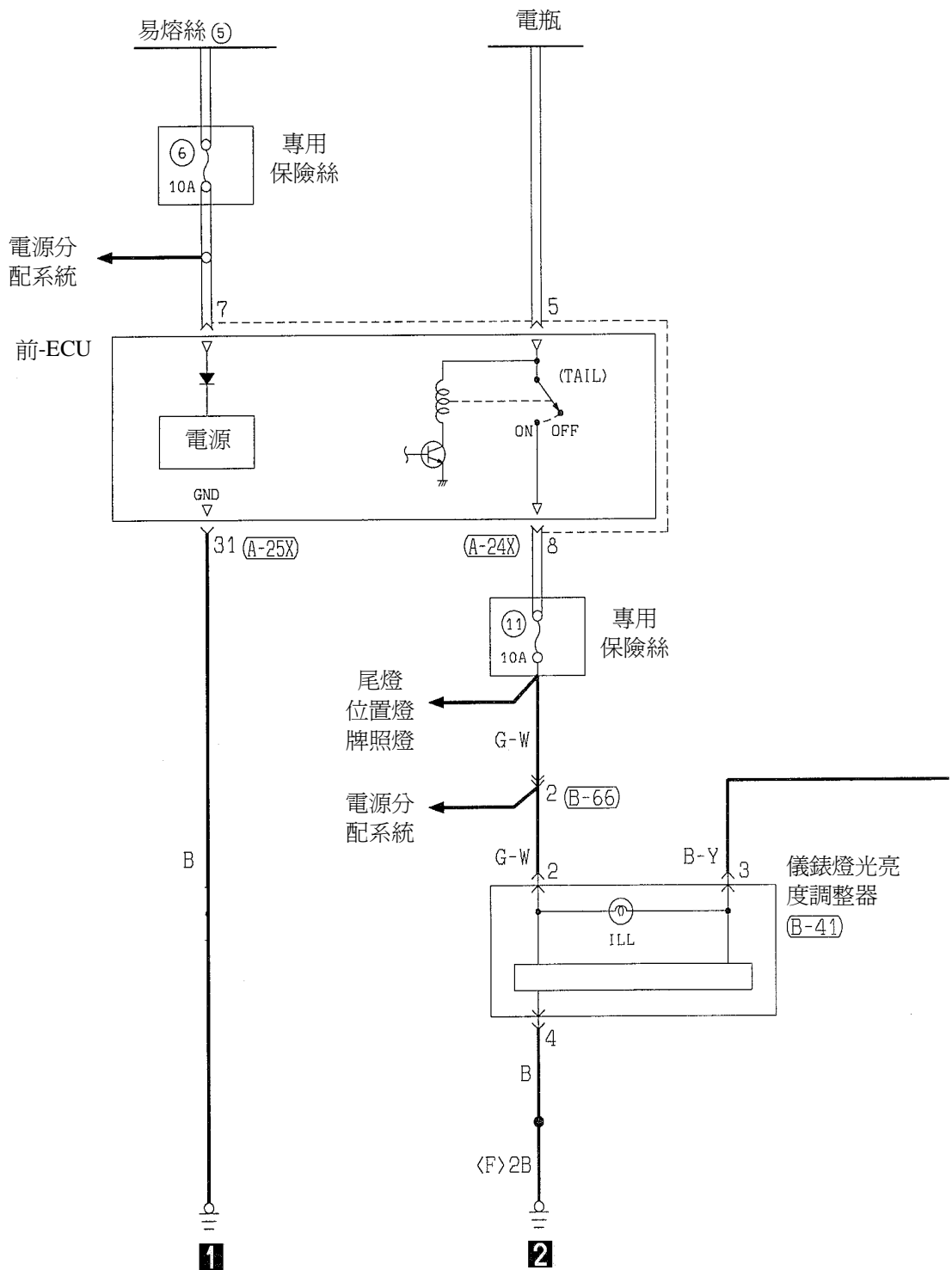

(A-24X)

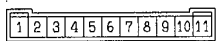

(A-25X)

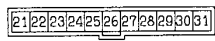

(B-41)

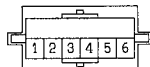

(B-44)



(B-66)

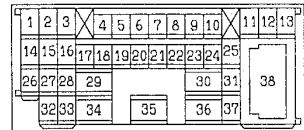

儀錶燈光亮度調整器

2

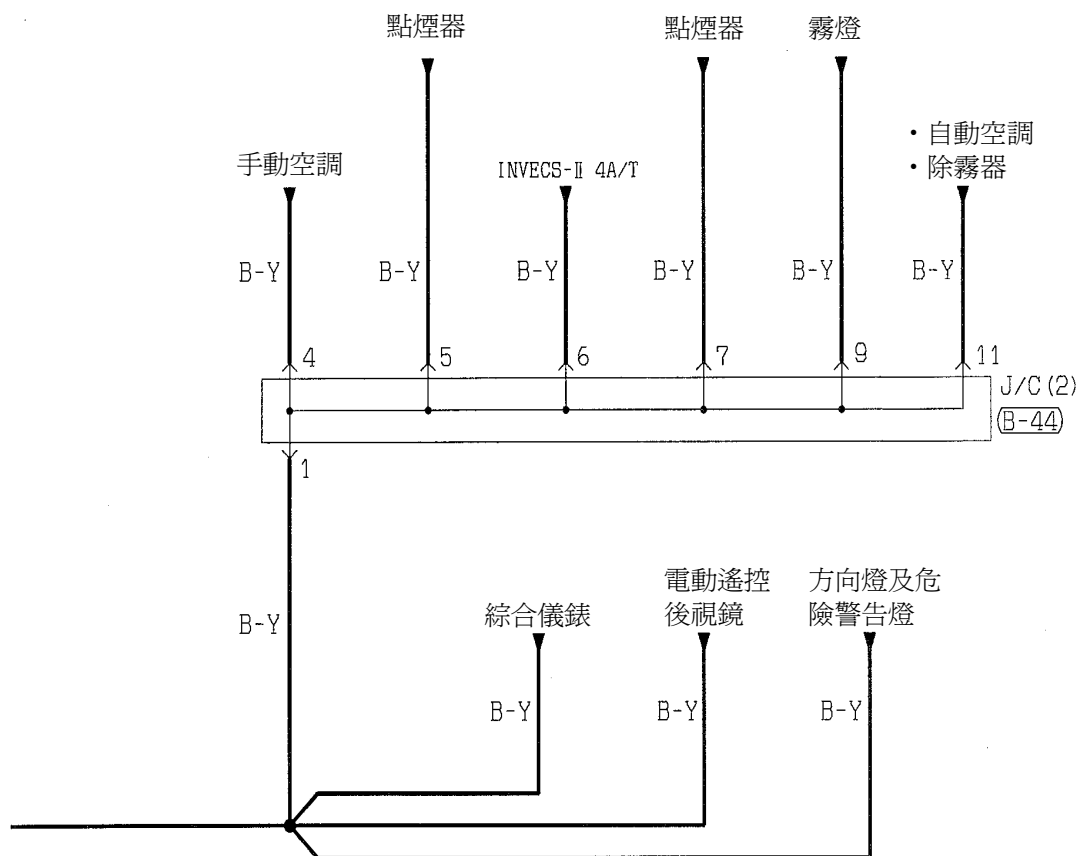

54D-136 DZL 迴路圖－燈光監視蜂鳴器

燈光監視蜂鳴器

1

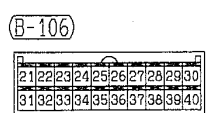
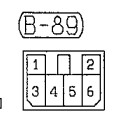
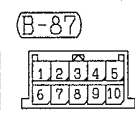
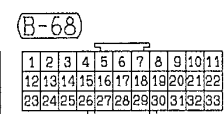
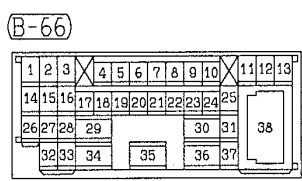
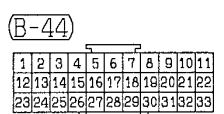
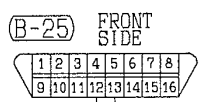
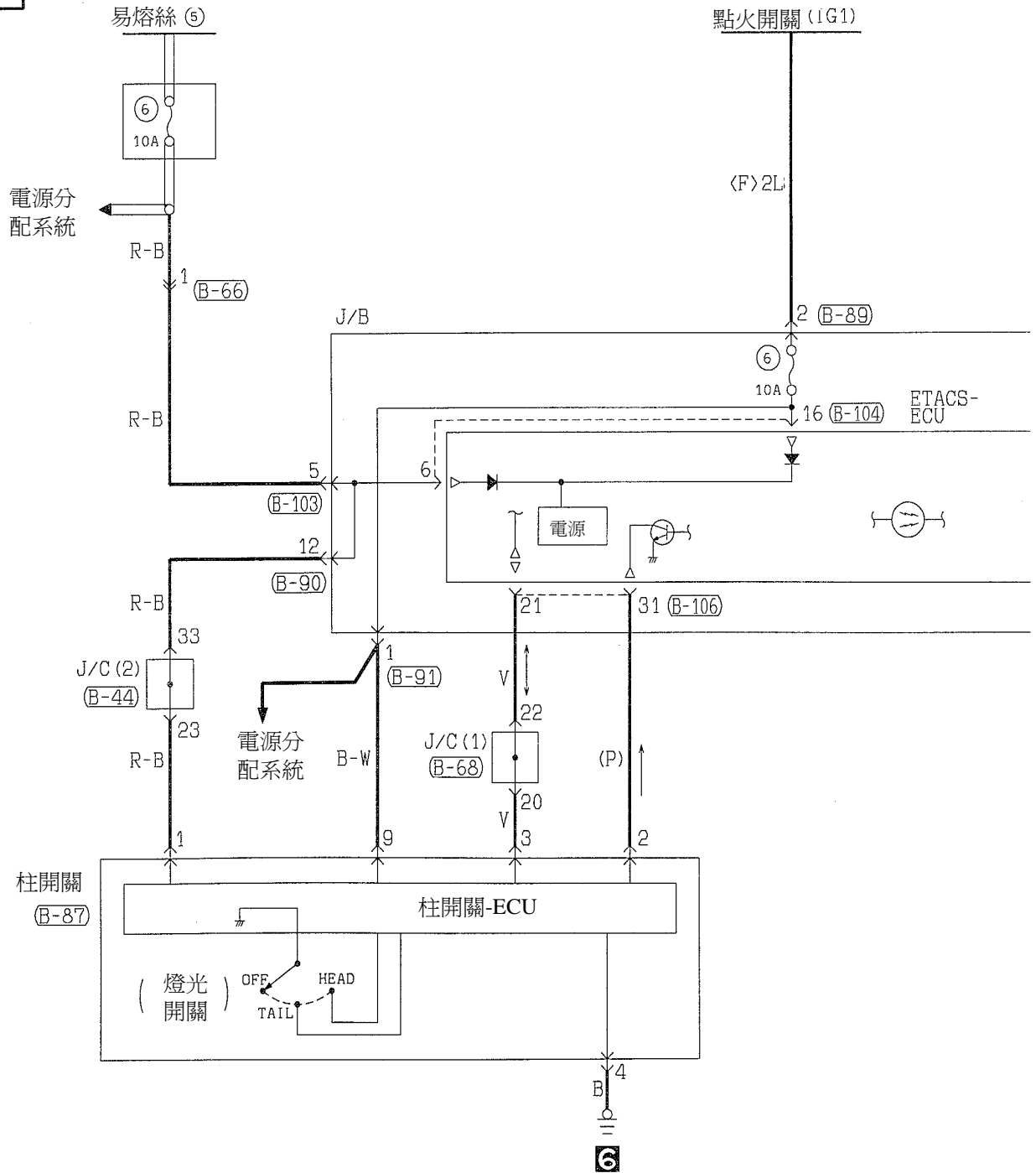

燈光監視蜂鳴器

2

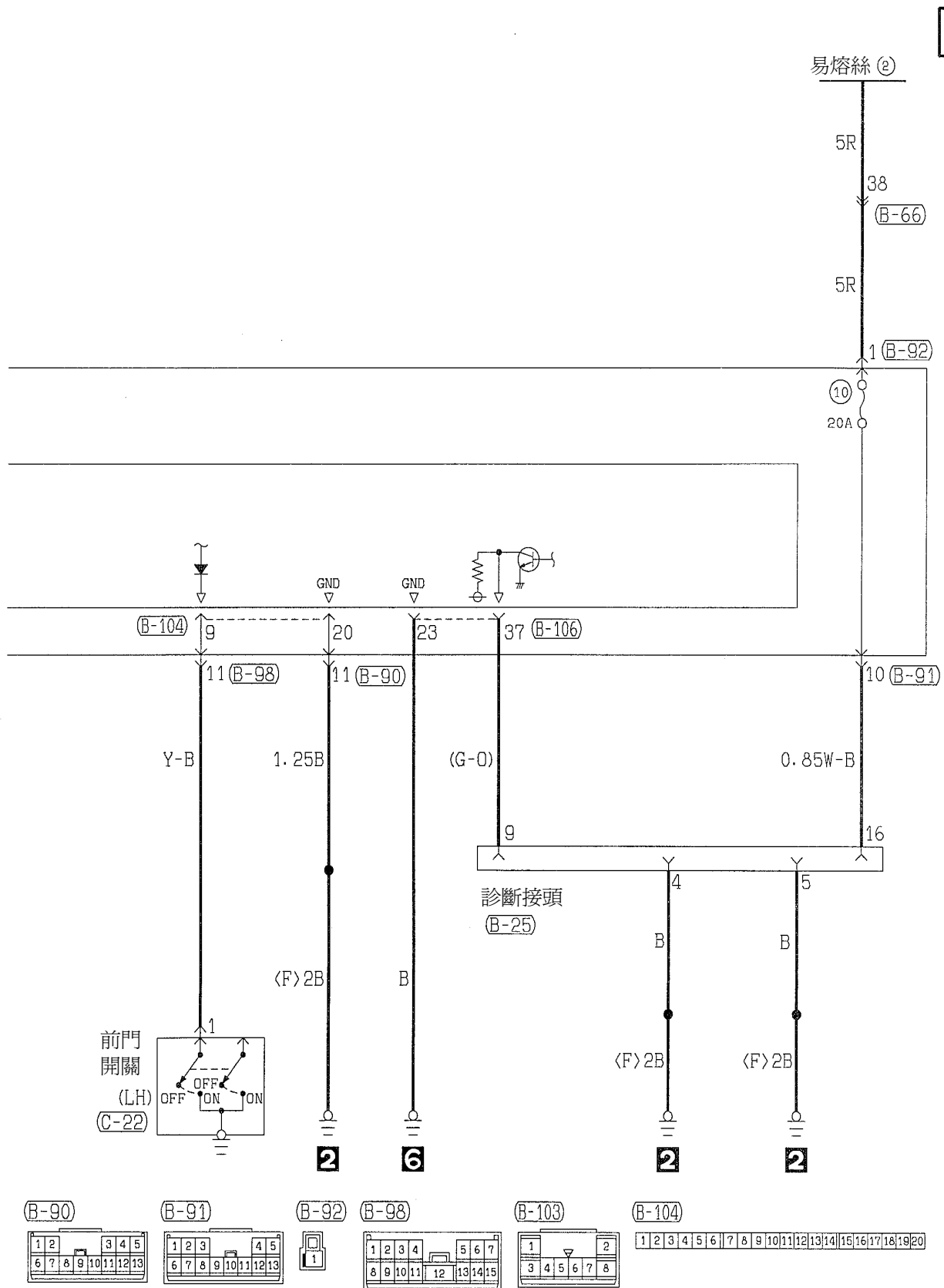

54D-138 DZL 迴路圖－鑰匙未取出蜂鳴器

鑰匙未取出蜂鳴器

1

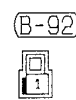
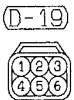
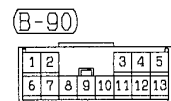
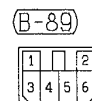
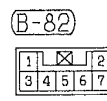
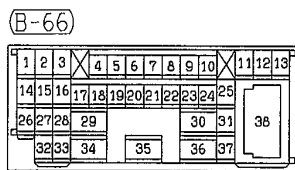
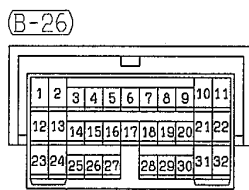
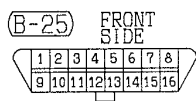
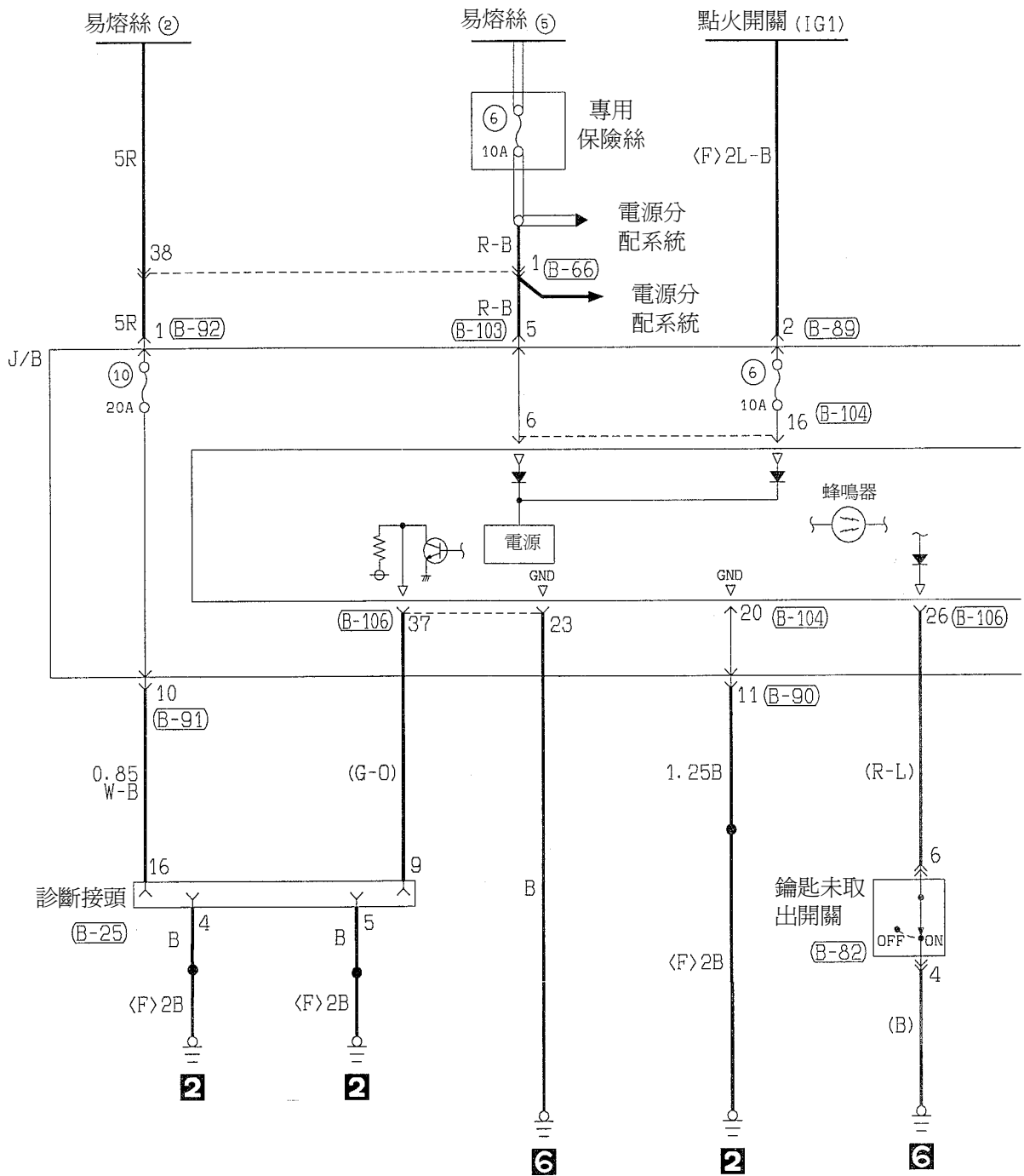

鑰匙未取出蜂鳴器

2

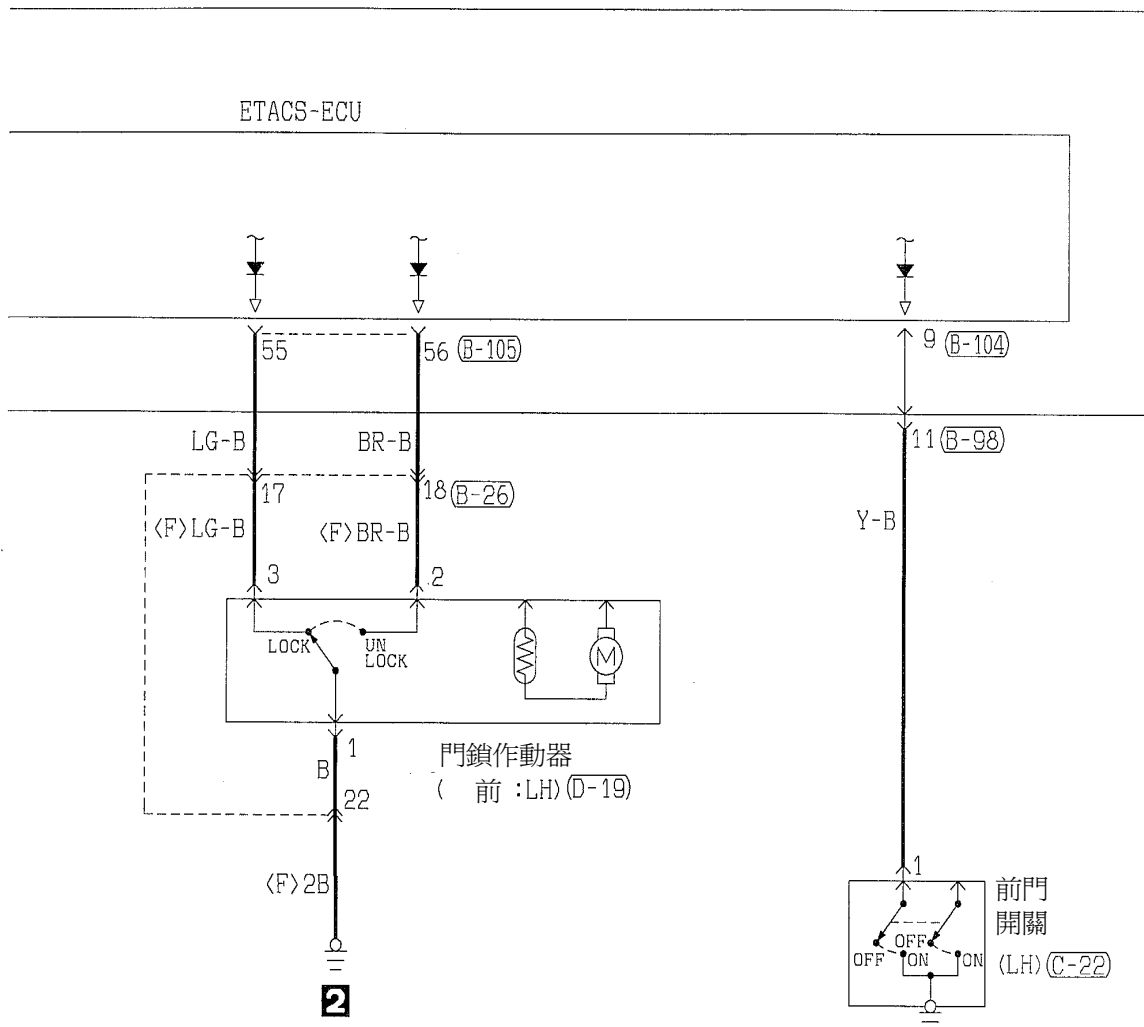

(B-98)

1	2	3	4	5	6	7	
A	9	10	11	12	13	14	15

(B-103)

1	2				
3	4	5	6	7	8

(B-104)

1	2	3	4	5	6	7	8	9	10	11	12	13	14	15	16	17	18	19	20
---	---	---	---	---	---	---	---	---	----	----	----	----	----	----	----	----	----	----	----

(B-105)

41	42	43	44	45	46	47	48
49	50	51	52	53	54	55	56

(B-106)

21	22	23	24	25	26	27	28	29	30
31	32	33	34	35	36	37	38	39	40

點煙器

1

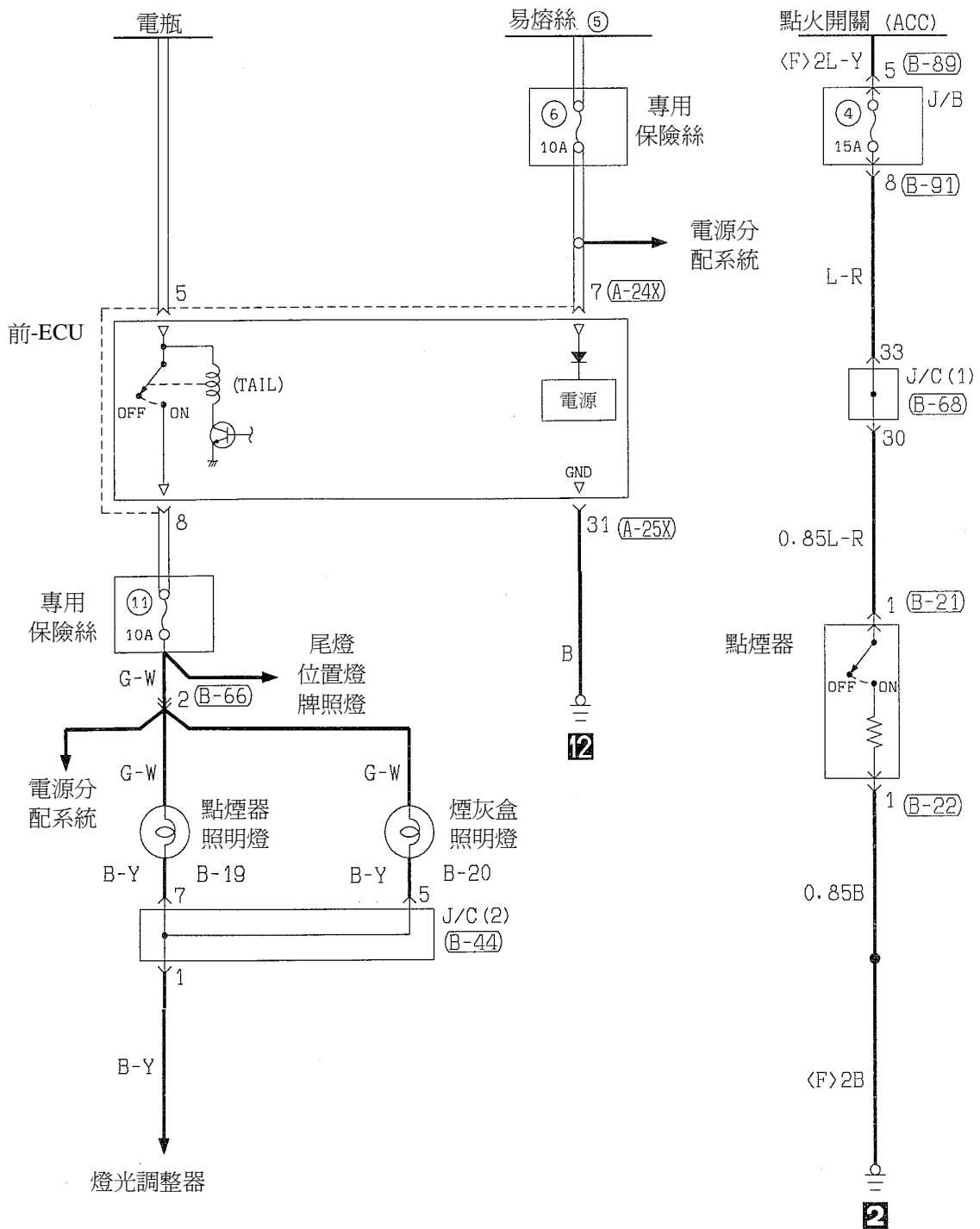

(A-24X)

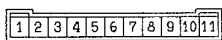

(A-25X)

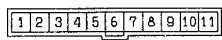

(B-21)



(B-22)

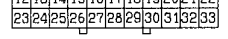
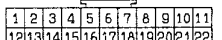

(B-66)

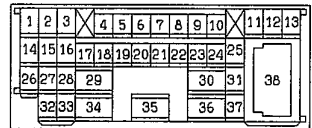

(B-68)

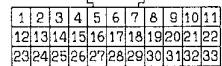

(B-89)



(B-91)

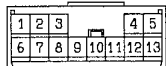

第二電源插座

1

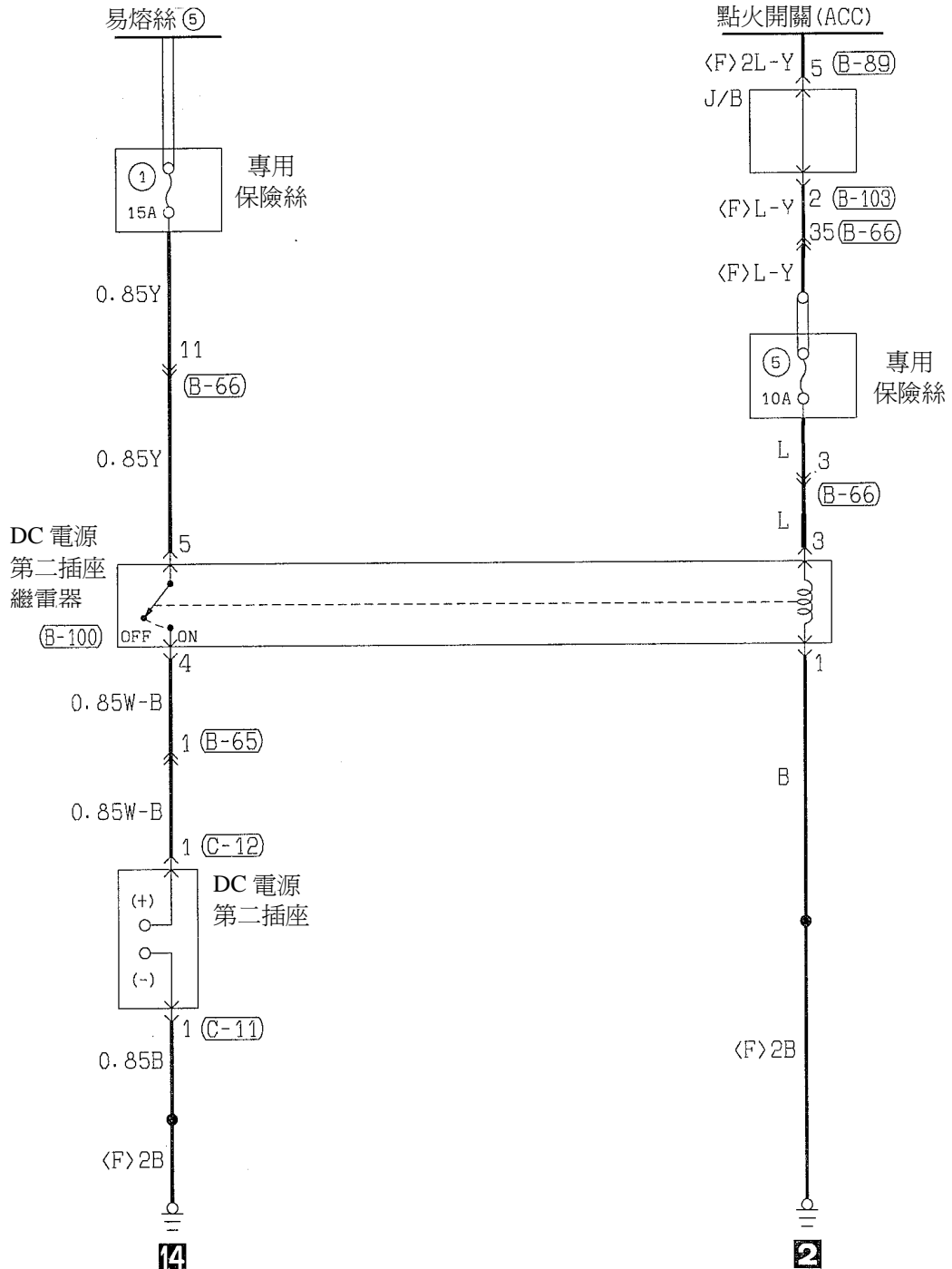

(B-65)

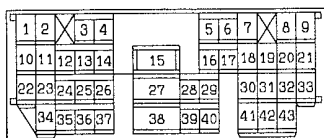

(B-66)

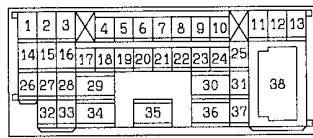

(B-68)

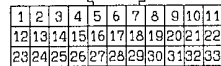

(B-89)



(B-100)



(B-103)

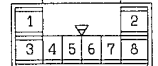

(C-11)



(C-12)



天窗

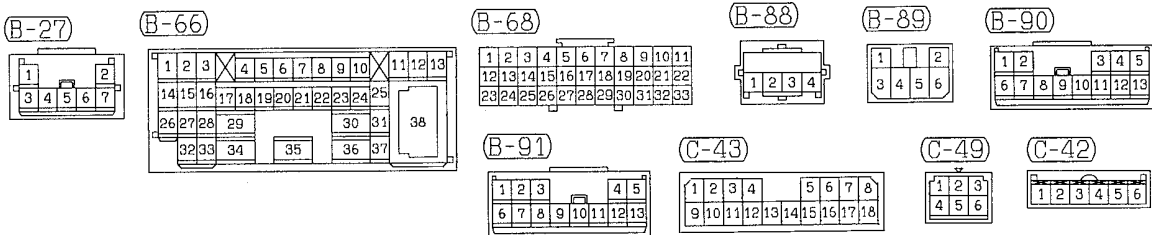
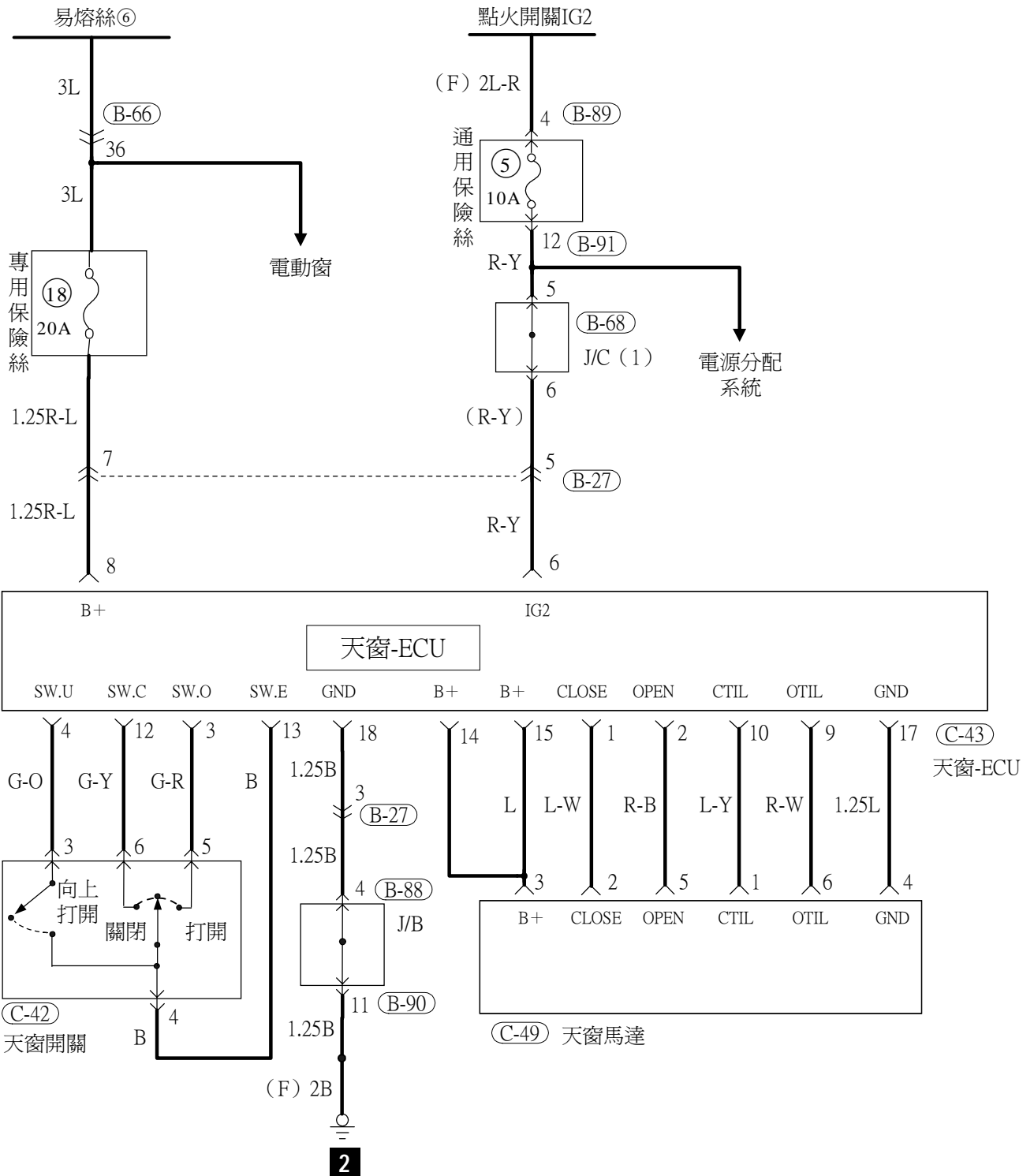

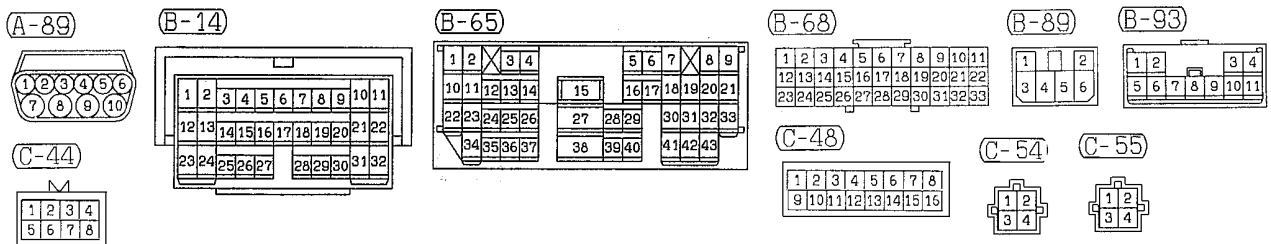
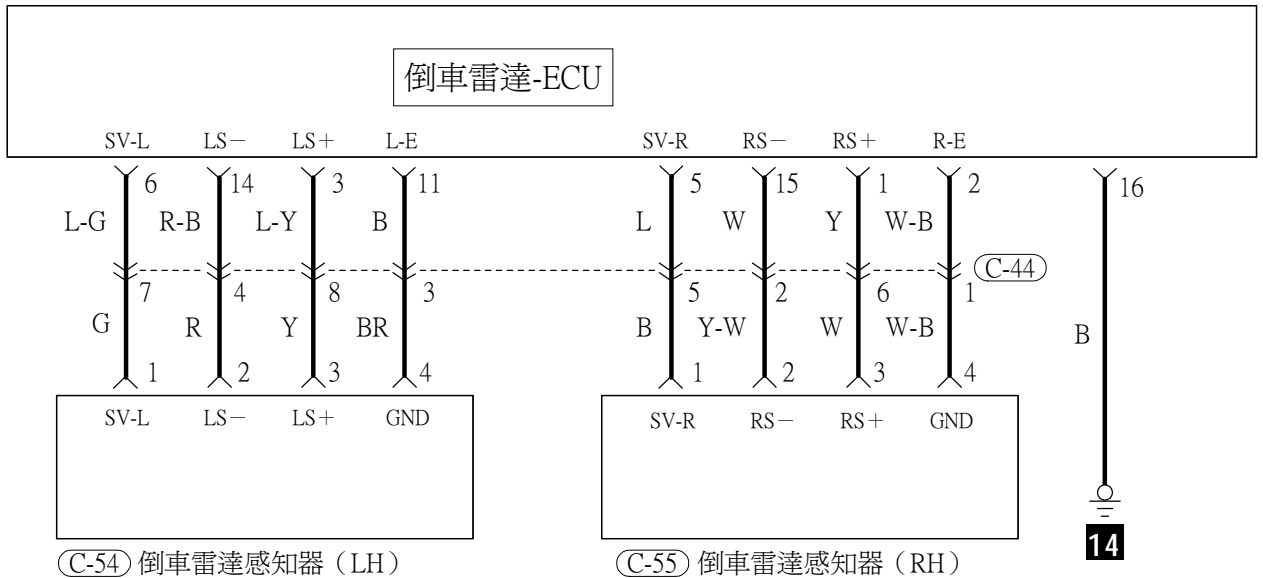
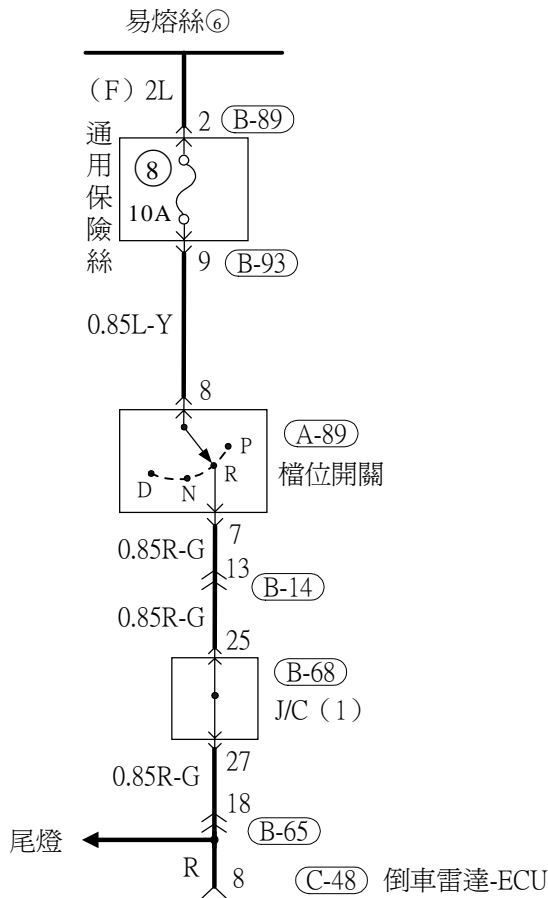

化妝鏡燈

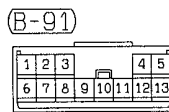
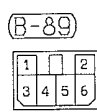
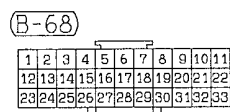
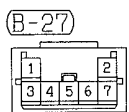
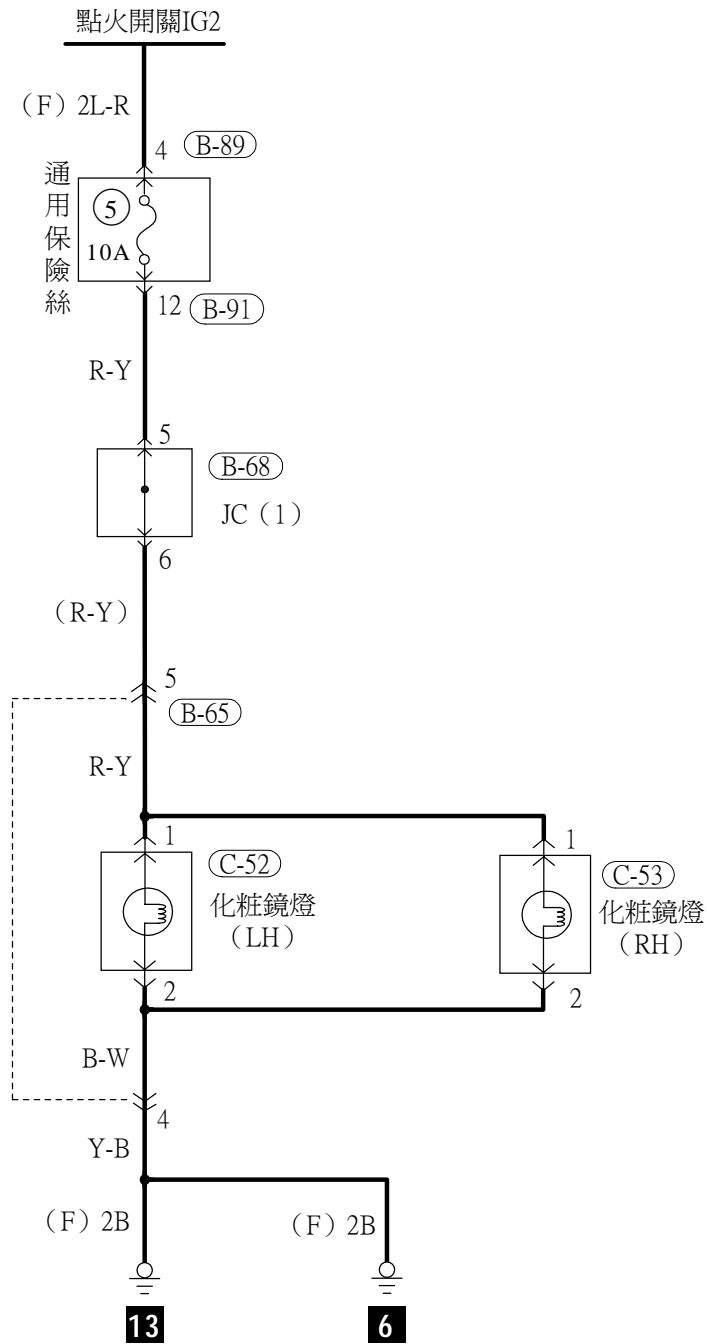

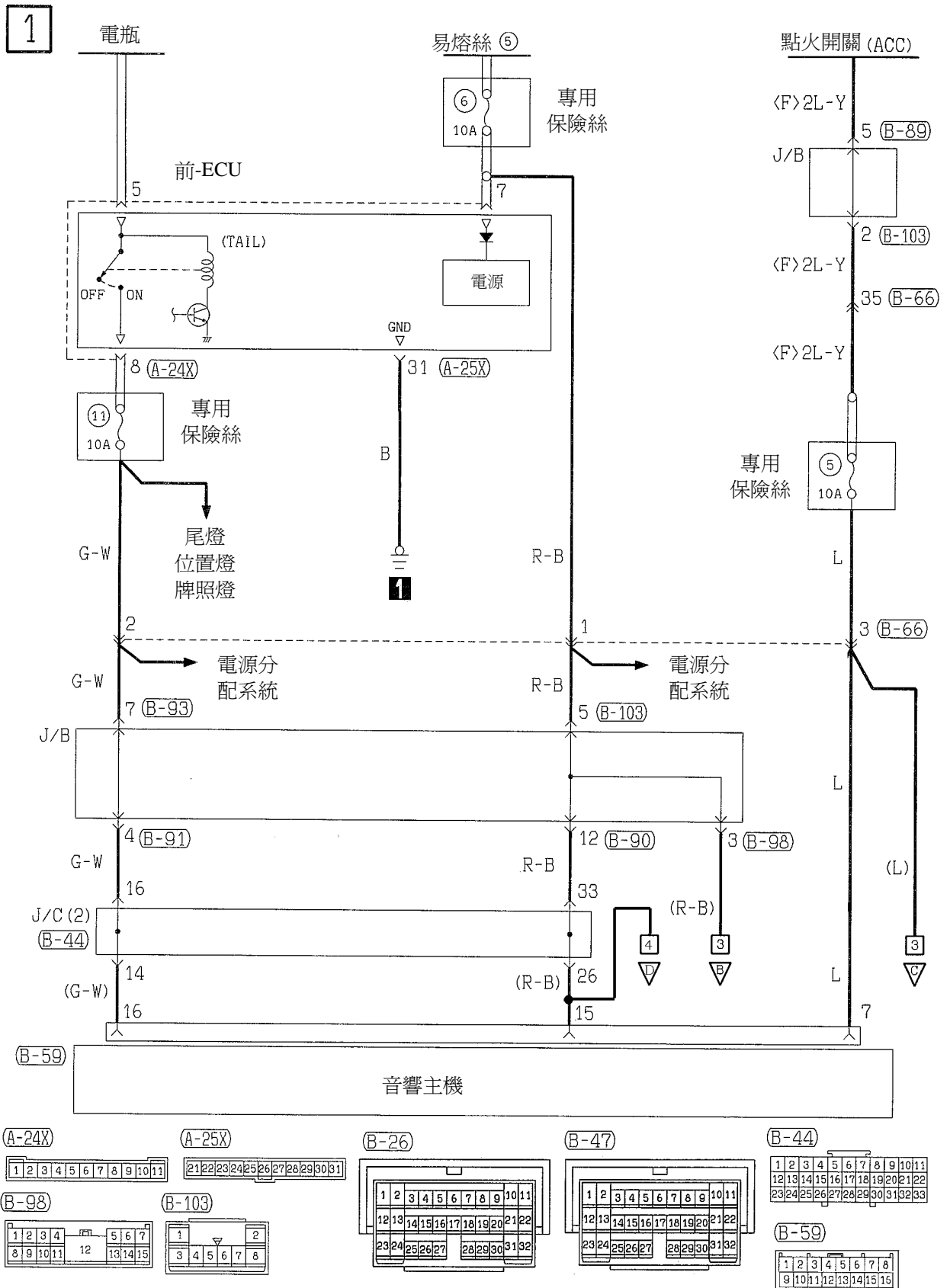

音響(續)-小型中央顯示螢幕

3

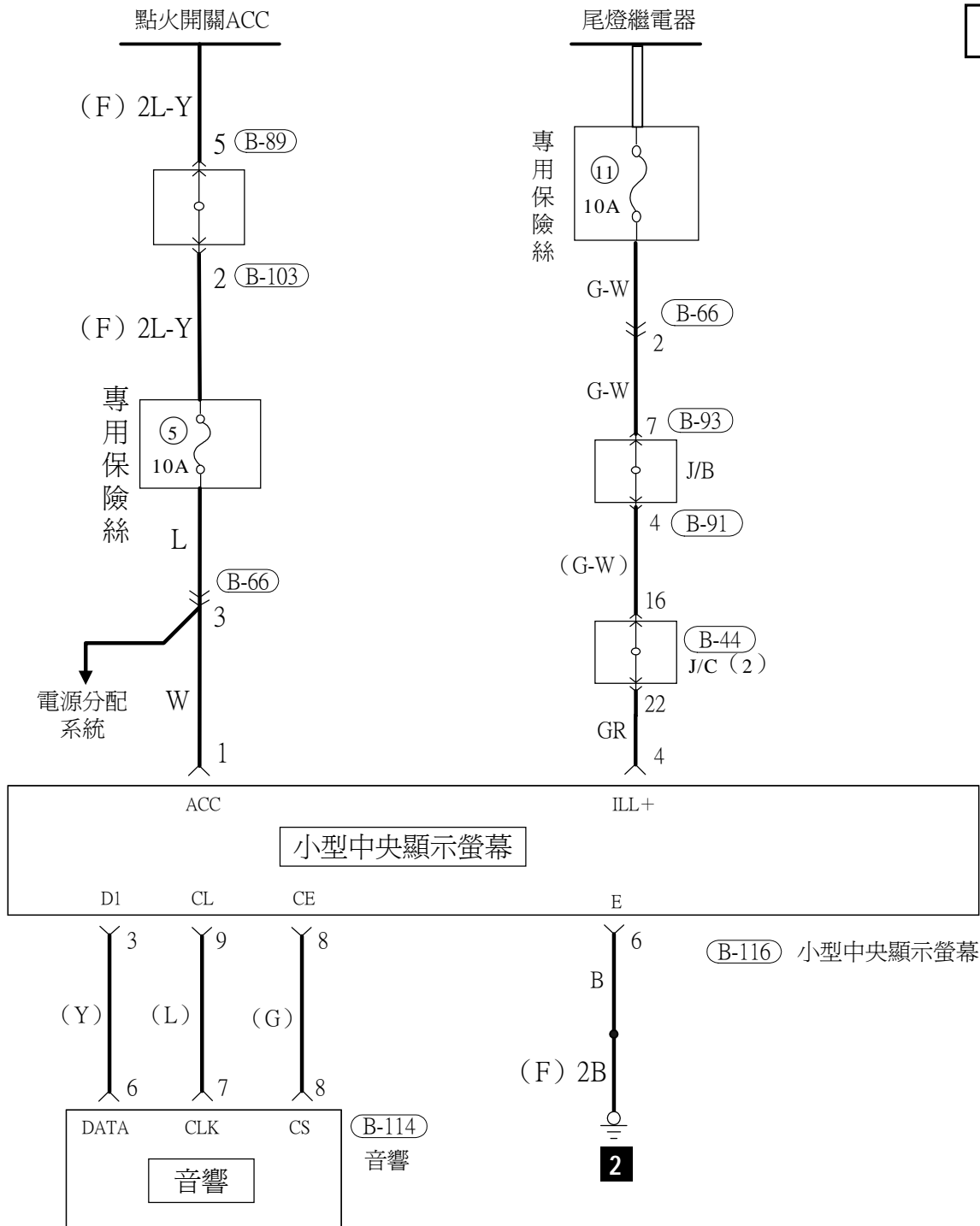

(B-44)



(B-114)

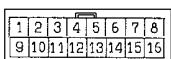

(B-66)

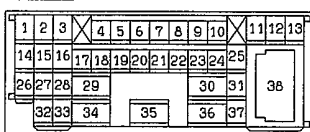

(B-89)



(B-91)

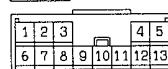

(B-116)

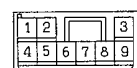

(B-93)

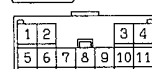

(B-103)



音響(續)-VCD

4

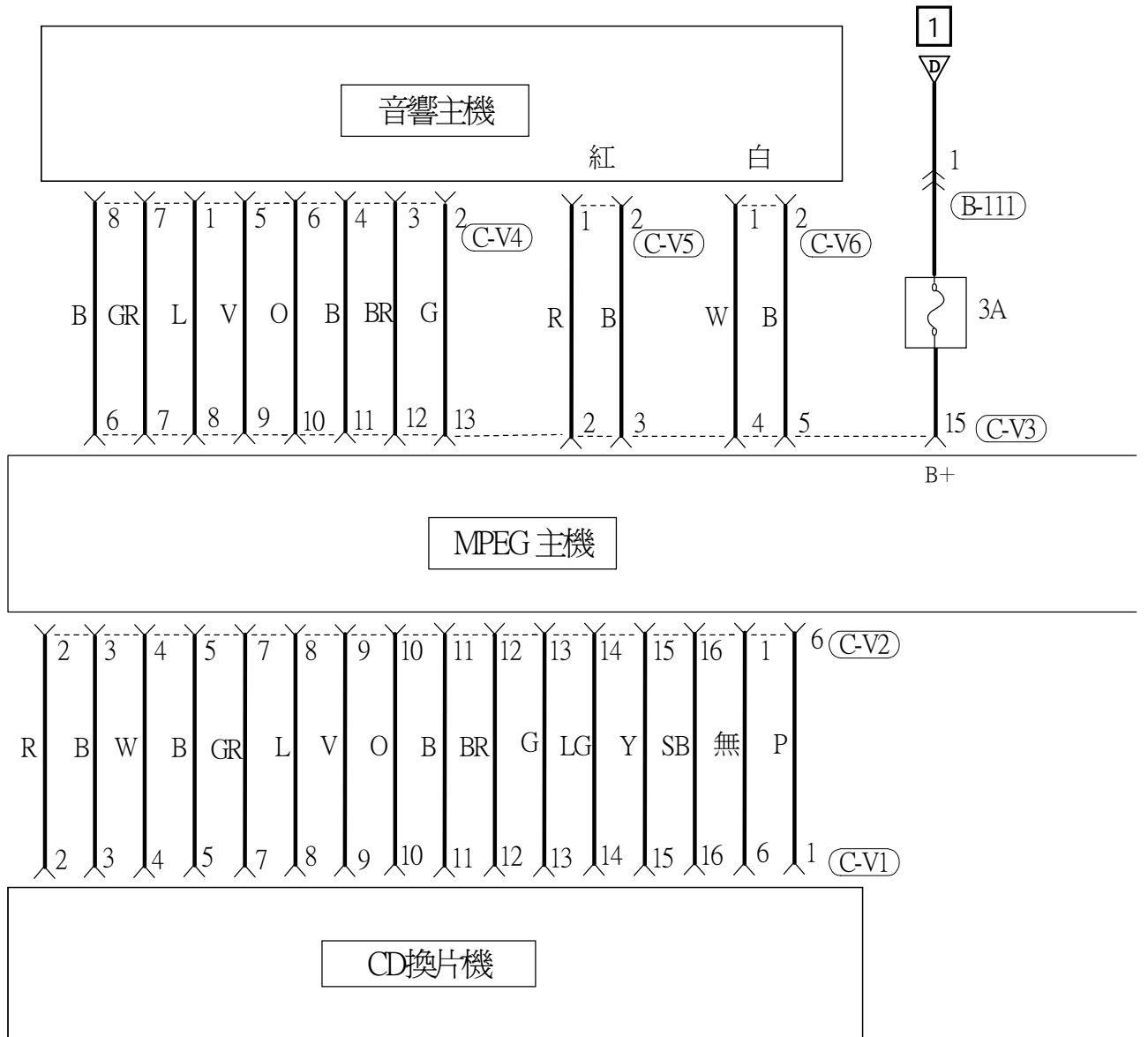

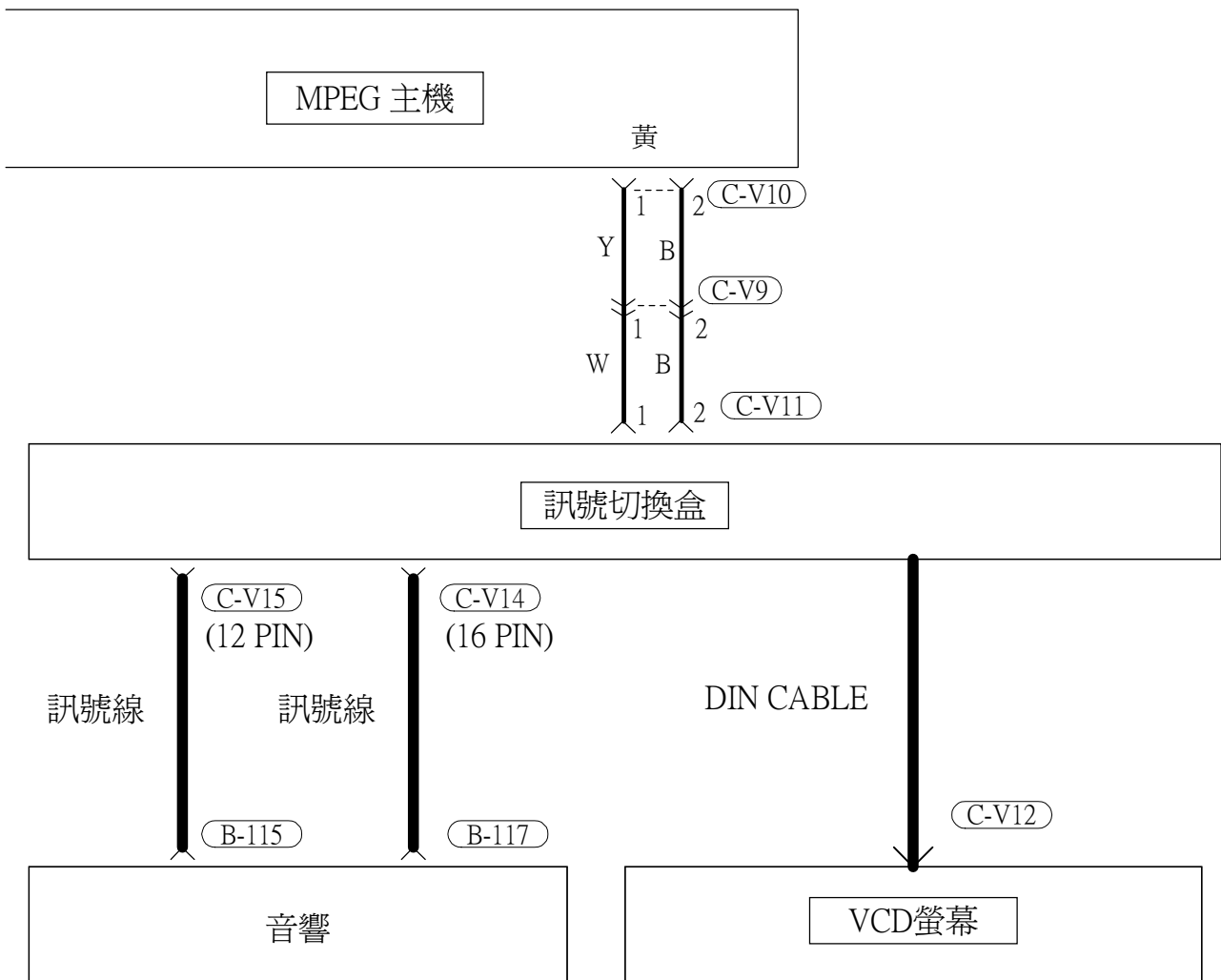

行動通訊系統

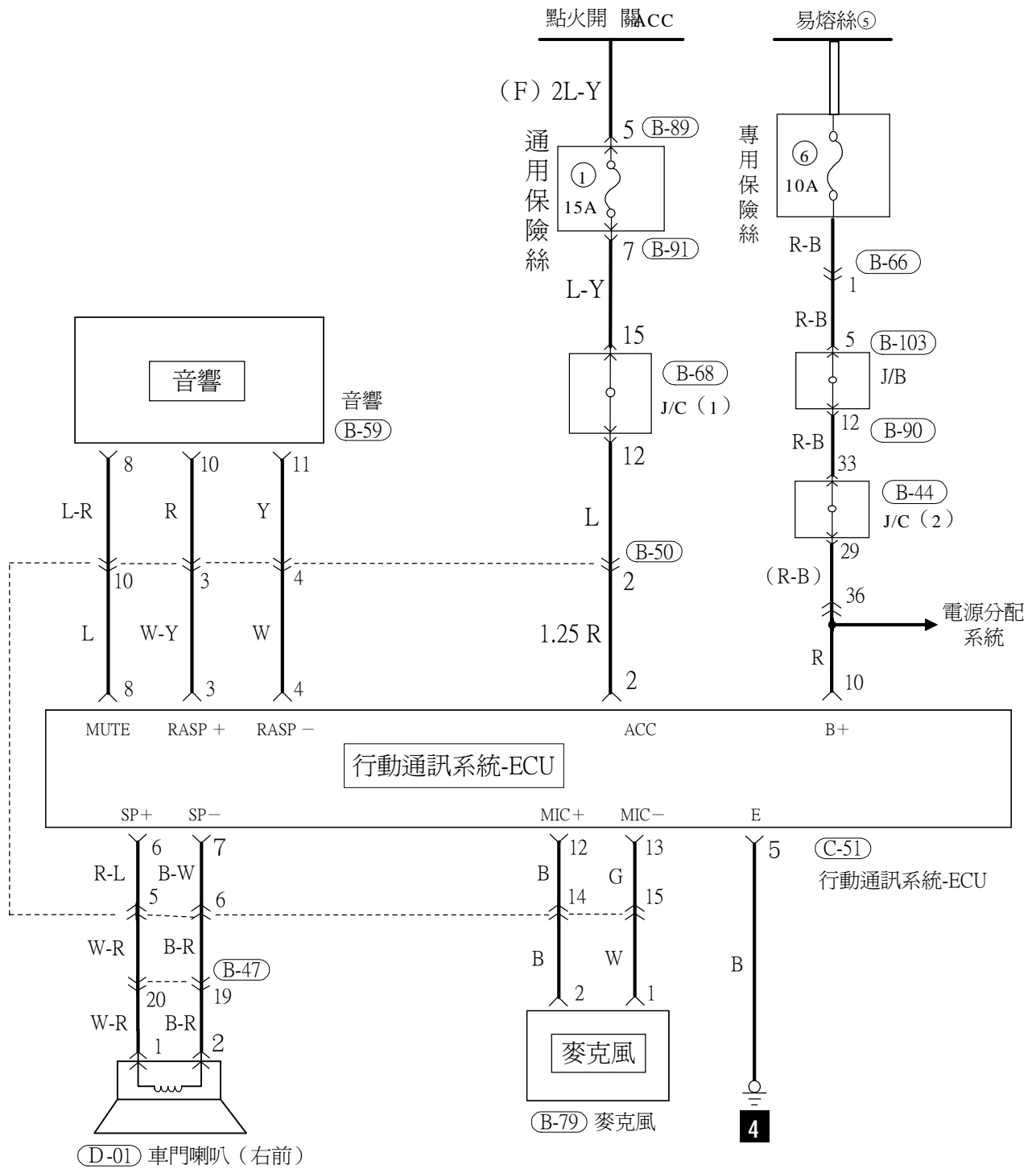

(B-44)

(B-47)

(B-49)

(B-66)

(B-59)

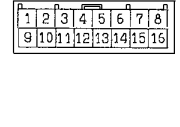
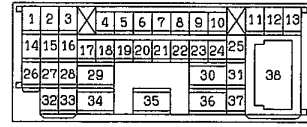
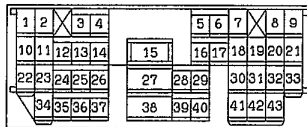
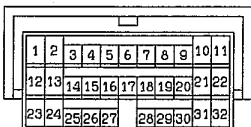
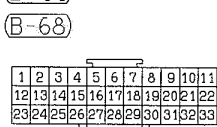

(B-50)

(B-79)

(B-89)

(B-90)

(B-91)

(B-103)

(C-51)

(D-01)

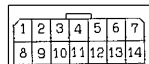
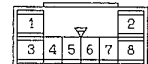
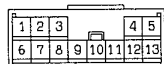
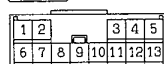
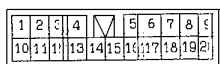

1

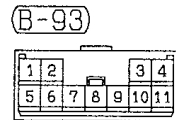
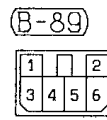
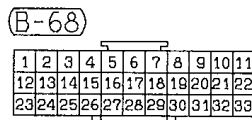
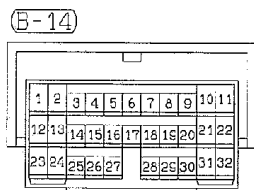
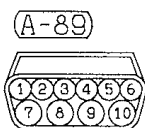
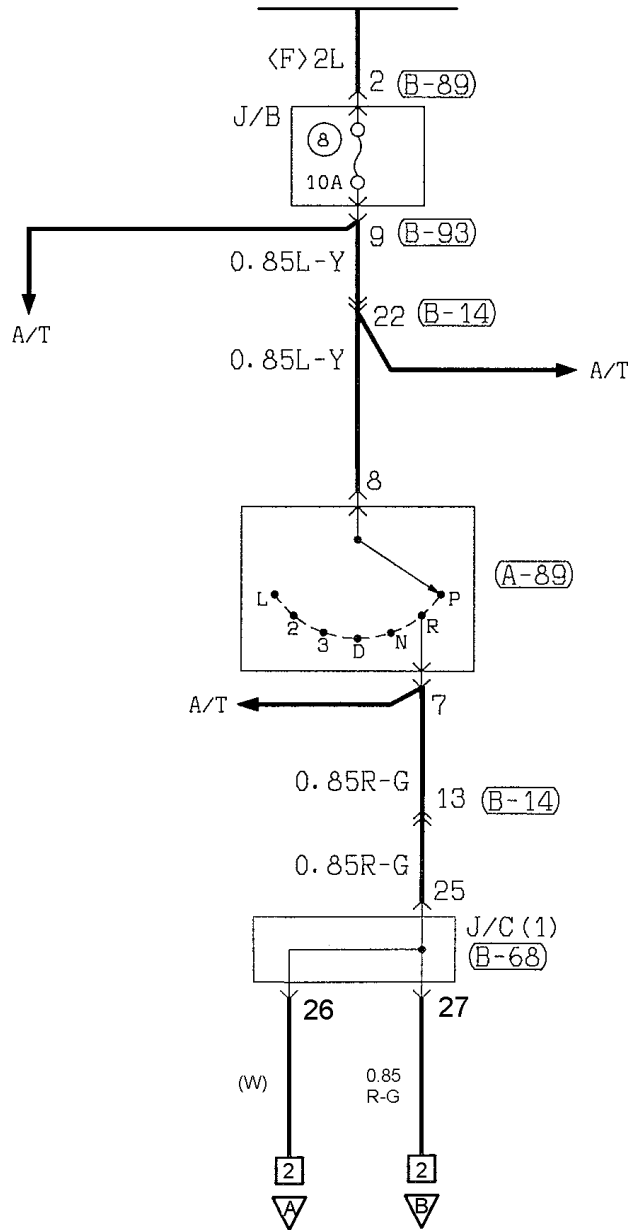

倒車攝影機

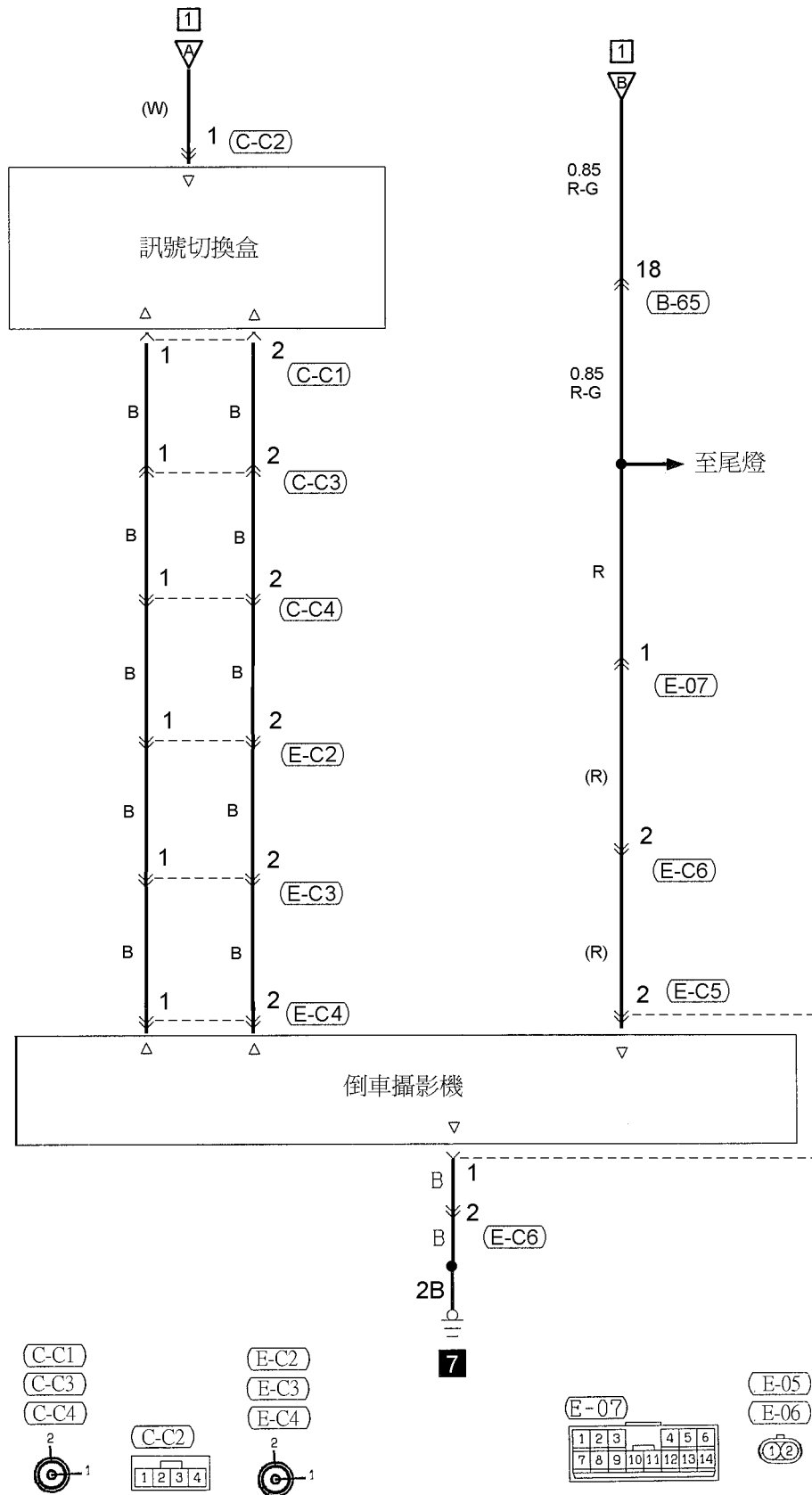

衛星導航系統

1

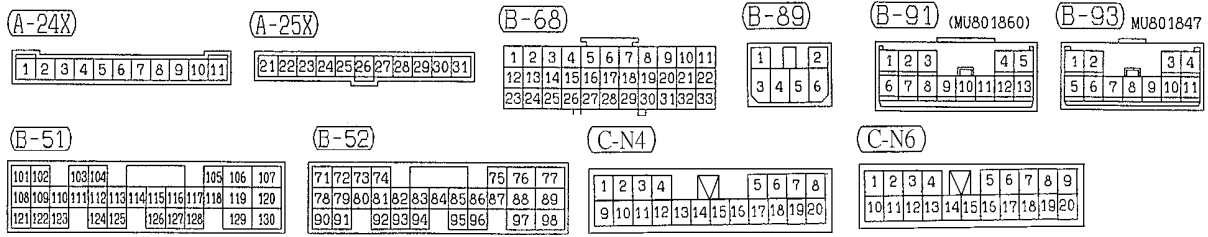
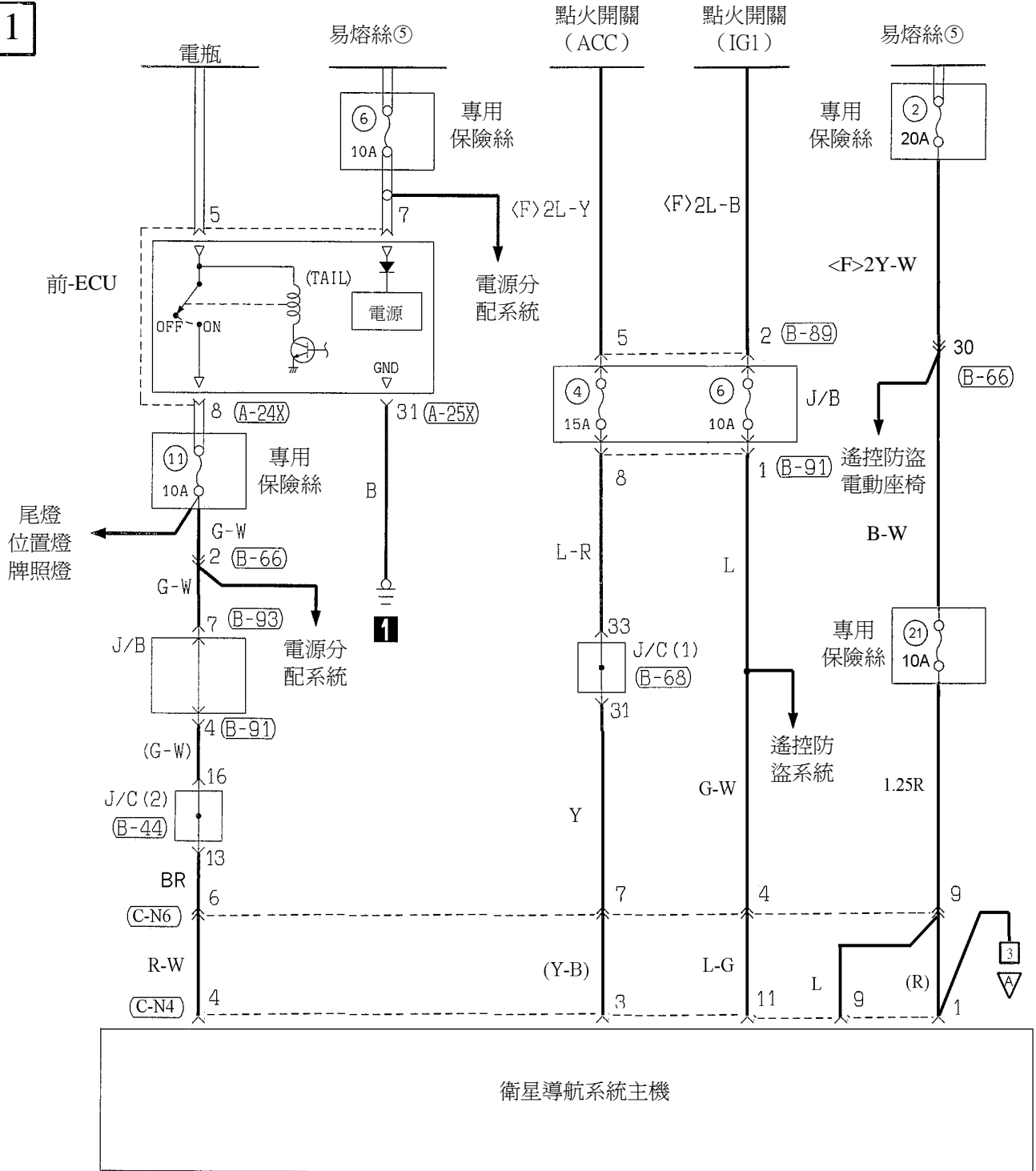

2

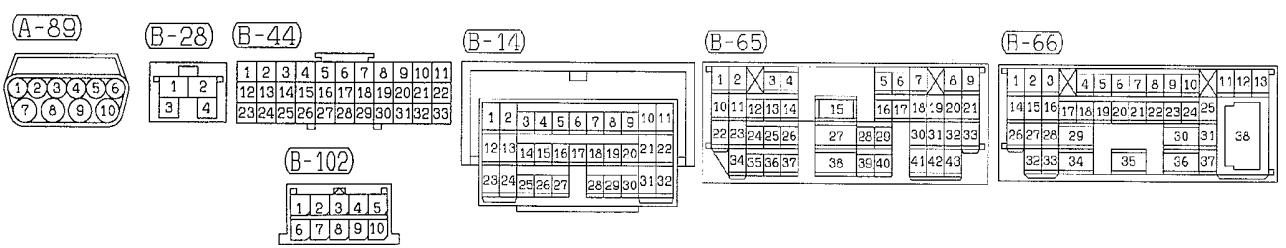
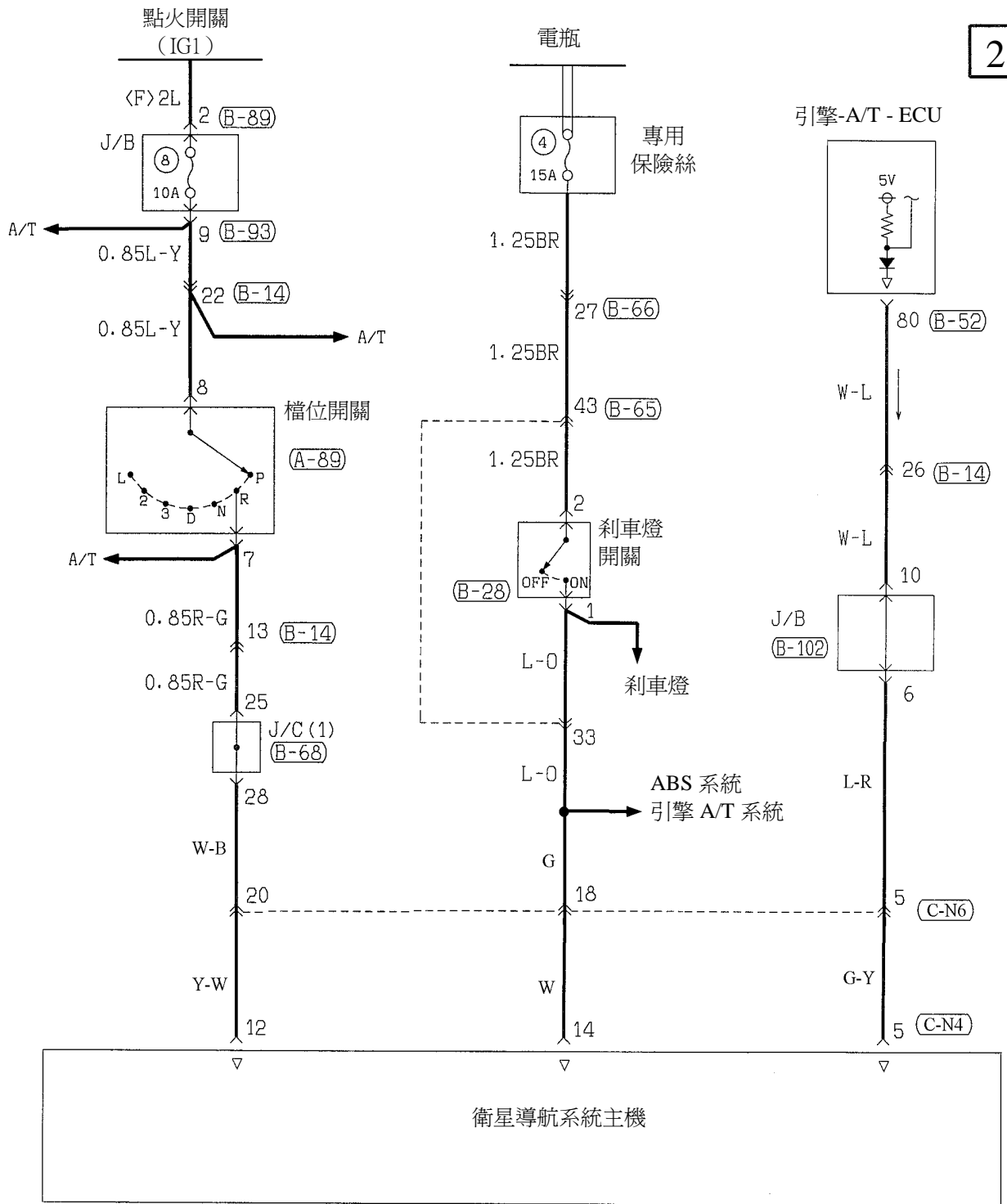

衛星導航系統

3

